

GOT Series

Human Machine Interface

Operation Manual

Graphic Operator Terminals F920GOT, F930GOT, F940GOT, F940/943 Handy GOT

Foreword

- This manual contains text, diagrams and explanations which will guide the reader in the correct installation and operation of GOT -F900.
- Before attempting to install or use GOT-F900 this manual should be read and understood.
- If in doubt at any stage of the installation of GOT-F900 always consult a professional electrical engineer who is qualified and trained to the local and national standards which apply to the installation site.
- If in doubt about the operation or use of GOT-F900 please consult the nearest Mitsubishi Electric distributor.
- This manual is subject to change without notice.

GRAPHIC OPERATION TERMINAL GOT-F900

OPERATION MANUAL

Manual number : JY992D94701

Manual revision : D

Date : May 2002

FAX BACK

Mitsubishi has a world wide reputation for its efforts in continually developing and pushing back the frontiers of industrial automation. What is sometimes overlooked by the user is the care and attention to detail that is taken with the documentation. However, to continue this process of improvement, the comments of the Mitsubishi users are always welcomed. This page has been designed for you, the reader, to fill in your comments and fax them back to us. We look forward to hearing from you.

Fax numbers:	Your name:.....
Mitsubishi Electric....
America (01) 847-478-2253	Your company:
Australia (02) 638-7072
Germany (0 21 02) 4 86-1 12	Your location:
Spain (34) 93-589-1579
United Kingdom (01707) 278-695	

Please tick the box of your choice

What condition did the manual arrive in? Good Minor damage Unusable

Will you be using a folder to store the manual? Yes No

What do you think to the manual presentation? Tidy Unfriendly

Are the explanations understandable? Yes Not too bad Unusable

Which explanation was most difficult to understand:

Are there any diagrams which are not clear? Yes No

If so, which:

What do you think to the manual layout? Good Not too bad Unhelpful

If there one thing you would like to see improved, what is it?

Could you find the information you required easily using the index and/or the contents, if possible please identify your experience:

Do you have any comments in general about the Mitsubishi manuals?

Thank you for taking the time to fill out this questionnaire. We hope you found both the product and this manual easy to use.

Guidelines for the Safety of the User and Protection of the Graphic operation terminal GOT-F900

This manual provides information for the use of the Graphic operation terminal GOT-F900. The manual has been written to be used by trained and competent personnel. The definition of such a person or persons is as follows;

- a) Any engineer who is responsible for the planning, design and construction of automatic equipment using the product associated with this manual should be of a competent nature, trained and qualified to the local and national standards required to fulfill that role. These engineers should be fully aware of all aspects of safety with regards to automated equipment.
- b) Any commissioning or service engineer must be of a competent nature, trained and qualified to the local and national standards required to fulfill that job. These engineers should also be trained in the use and maintenance of the completed product. This includes being completely familiar with all associated documentation for the said product. All maintenance should be carried out in accordance with established safety practices.
- c) All operators of the completed equipment should be trained to use that product in a safe and coordinated manner in compliance to established safety practices. The operators should also be familiar with documentation which is connected with the actual operation of the completed equipment.

Note : Note: the term ‘completed equipment’ refers to a third party constructed device which contains or uses the product associated with this manual.

Notes on the Symbols Used in this Manual

At various times through out this manual certain symbols will be used to highlight points of information which are intended to ensure the users personal safety and protect the integrity of equipment. Whenever any of the following symbols are encountered its associated note must be read and understood. Each of the symbols used will now be listed with a brief description of its meaning.

Hardware Warnings



1) Indicates that the identified danger **WILL** cause physical and property damage.



2) Indicates that the identified danger could **POSSIBLY** cause physical and property damage.



3) Indicates a point of further interest or further explanation.

Software Warnings



4) Indicates special care must be taken when using this element of software.



5) Indicates a special point which the user of the associate software element should be aware of.



6) Indicates a point of interest or further explanation.

- Under no circumstances will Mitsubishi Electric be liable or responsible for any consequential damage that may arise as a result of the installation or use of this equipment.
- All examples and diagrams shown in this manual are intended only as an aid to understanding the text, not to guarantee operation. Mitsubishi Electric will accept no responsibility for actual use of the product based on these illustrative examples.
- Owing to the very great variety in possible application of this equipment, you must satisfy yourself as to its suitability for your specific application.

Table of Contents

Manual configuration and various data	1
1. Introduction.....	1-1
1.1 Outline	1-1
1.2 Format of manual	1-3
1.2.1 Contents described in manual	1-3
1.2.2 Abbreviations used in text	1-4
1.3 Expressions and basic functions of operation keys	1-6
1.3.1 Expressions of operation keys	1-6
1.3.2 Basic operations	1-6
1.4 System configuration	1-7
1.4.1 Connection of GOT with peripheral units	1-7
1.5 Applicable PLC	1-9
1.6 GOT version upgrade history	1-13
1.7 Screen creation software version upgrade history	1-17
1.8 Preservation of screen data and backup	1-19
2. Specifications	2-1
2.1 General specifications	2-1
2.2 Display section specifications	2-2
3. Name of Display Unit.....	3-1
3.1 Front panel	3-1
3.2 Rear panel	3-3
3.3 Functions of ports	3-4
4. Function.....	4-1
4.1 Function list	4-1
5. Start Up	5-1
5.1 Start up procedure	5-1
5.2 System settings	5-3
5.2.1 Outline of operation environment setting	5-3
5.2.2 LANGUAGE	5-5
5.2.3 PLC TYPE	5-6
5.2.4 SERIAL PORT	5-7
5.2.5 OPENING SCREEN	5-7
5.2.6 MAIN MENU CALL KEY	5-8
5.2.7 SET CLOCK	5-9
5.2.8 SET BACKLIGHT	5-9
5.2.9 BUZZER	5-10
5.2.10 LCD CONTRAST	5-10
5.2.11 CLEAR USER DATA	5-11
5.2.12 HANDY GOT SETTING	5-12
5.2.13 AUXILIARY SETTING	5-13
5.3 Each mode selection procedure	5-14
5.4 Security function (screen protection function)	5-16
5.4.1 Outline of security function	5-16
5.4.2 Input of entry code	5-17
5.4.3 Reset of entry code	5-19
5.4.4 Upgrading of security function	5-20

6. Creation of Display Screens	6-1
6.1 Outline of compatibility of screen data	6-2
6.1.1 Functions dedicated to screen creation software FX-PCS-DU/WIN-E	6-3
6.1.2 Common functions	6-4
6.1.3 Functions dedicated to GT Designer	6-6
6.2 Transfer of screen data	6-7
6.3 Appropriation of screen data	6-9
6.3.1 Conversion from FX-50DU-TK(S)-E to F940GOT	6-9
6.4 Concept on screen display	6-10
6.4.1 Screen display position	6-10
6.4.2 Number of display screens and screen numbers	6-10
6.4.3 Number of display elements and data capacity	6-10
6.4.4 Attribute of display element	6-11
6.5 Screen call function and overlay function	6-14
6.5.1 The writing function of the initial display screen number (GT Designer is used.)....	6-15
6.5.2 Screen call function	6-16
6.5.3 Overlay function	6-17
6.6 Interface Devices and system information.....	6-25
6.6.1 Interface Devices (setting in FX-PCS-DU/WIN-E).....	6-25
6.6.2 System Information (setting in GT Designer)	6-28
7. USER SCREEN MODE	7-1
7.1 Display format.....	7-2
7.2 Display size	7-3
7.3 Outline of USER SCREEN MODE	7-6
7.4 Number of registered screen construction elements	7-8
7.5 Change of displayed data.....	7-10
7.5.1 Data change condition.....	7-10
7.6 Data change using touch keys	7-11
7.6.1 Common items in data change using touch keys	7-11
7.6.2 Data change procedure using touch key	7-12
7.6.3 Key window display in F930GOT-K.....	7-13
7.6.4 Decimal point input function	7-16
7.6.5 Key window display position specification	7-17
7.6.6 Creation of key window	7-19
7.7 Data change using key pad (F920GOT-K and F930GOT-K)	7-22
7.7.1 Data change operation using key pad	7-22
7.7.2 Cursor key operation	7-24
7.8 Numeric setting completion flag and data changing flag	7-29
8. HPP Mode	8-1
8.1 Outline of HPP mode	8-1
8.2 PROGRAM LIST	8-3
8.3 PARAMETER	8-12
8.4 DEVICE MONITOR	8-14
8.4.1 Device/comment monitor.....	8-16
8.4.2 Changing set values and current values of T, C and D	8-17
8.4.3 Forced ON/OFF	8-19
8.5 LIST MONITOR	8-20
8.6 ACTIVE STATE MONITOR	8-21
8.7 BFM MONITOR	8-22
8.8 PC DIAGNOSIS.....	8-24

9. Sampling MODE.....	9-1
9.1 Outline of sampling mode.....	9-1
9.2 Outline of sampling condition setting.....	9-3
9.2.1 SAMPLE COND.....	9-5
9.2.2 START COND.....	9-6
9.2.3 END COND.....	9-7
9.2.4 SAMPLING DEV.....	9-9
9.3 Display of sampling result.....	9-10
9.3.1 DISPLAY LIST.....	9-10
9.3.2 DISPLAY GRAPH.....	9-10
9.4 CLEAR DATA.....	9-11
9.5 Control signals in PLC.....	9-12
9.5.1 When FX-PCS-DU/WIN-E is used.....	9-12
9.5.2 When GT Designer.....	9-12
10.Alarm MODE.....	10-1
10.1 Outline of alarm function.....	10-1
10.2 Alarm function in screen mode.....	10-2
10.2.1 Set item.....	10-3
10.2.2 Operation in F920GOT-K.....	10-5
10.2.3 Alarm history clear using key code.....	10-6
10.3 Alarm function in alarm mode.....	10-8
10.3.1 Operation when alarms have occurred.....	10-9
10.3.2 Alarm list.....	10-11
10.3.3 Alarm history display.....	10-13
10.3.4 Alarm frequency display.....	10-14
10.3.5 Alarm history clear.....	10-15
11.Test MODE.....	11-1
11.1 Outline of test mode.....	11-1
11.2 USER SCREEN.....	11-2
11.3 DATA BANK.....	11-3
11.4 DEBUG.....	11-4
11.5 Communication monitor.....	11-7
11.5.1 Function Outline.....	11-7
11.5.2 Applicable version.....	11-7
11.5.3 Screen Display.....	11-7
12.Other MODE.....	12-1
12.1 Outline of other mode.....	12-1
12.2 SET TIME SWITCH.....	12-2
12.3 DATA TRANSFER.....	12-4
12.4 PRINT OUT.....	12-5
12.5 ENTRY CODE.....	12-7
12.6 SET UP MODE.....	12-8
13.Connection to Bar Code Reader.....	13-1
13.1 Outline of function.....	13-1
13.2 Applicable version.....	13-1
13.3 Connection.....	13-1

14.Screen Hard Copy Function	14-1
14.1 Outline of hardware copy operation.....	14-1
14.2 Applicable version	14-2
14.3 Starting and aborting printing	14-2
14.3.1 Start and abortion by triggers	14-2
14.3.2 Start and abortion by touch keys	14-2
14.3.3 Hard copy output signal (GT Designer)	14-3
14.3.4 Printing image	14-4
15.Buzzer	15-1
15.1 Applicable Version	15-1
15.2 GB and buzzer sounds	15-1
15.3 Use example of buzzer sounds by GB (GT Designer).....	15-2
16.Observe Status Function	16-1
16.1 Outline of observe status function	16-1
16.2 Applicable version	16-2
16.3 Observe cycle	16-2
16.4 Setting the triggers	16-3
16.5 Setting the operation	16-4
16.6 Trigger and number of devices	16-7
16.7 Cautions when many triggers and devices are set.....	16-8
16.8 Use example (utilization of clock data)	16-9
17.Key Pad (F920GOT-K and F930GOT-K)	17-1
17.1 Function keys	17-1
17.1.1 Assignment of function keys.....	17-2
17.1.2 Assignment of LEDs (F930GOT-K).....	17-3
17.2 Handling of ten-keys, cursor control keys, "SET" key, "DEV" key, "ESC" key and "ENT" key.....	17-4

18. Creation of Display Screens (FX-PCS-DU/WIN-E)	18-1
18.1 Parts list	18-1
18.2 Application and setting item	18-4
18.3 Registration of object	18-7
18.4 Display objects	18-8
18.4.1 Text	18-8
18.4.2 Line	18-9
18.4.3 Box	18-10
18.4.4 Filled Box	18-11
18.4.5 Circle	18-12
18.4.6 Filled Circle	18-13
18.4.7 Image	18-14
18.4.8 Date and time	18-15
18.5 Data display objects	18-16
18.5.1 Library Text	18-16
18.5.2 Number	18-18
18.5.3 Bar Graph	18-21
18.5.4 Circle Graph	18-24
18.5.5 Proportional Bar Graph	18-25
18.5.6 Proportional Pie Graph	18-26
18.5.7 Panel Meter	18-27
18.5.8 Indicator	18-28
18.5.9 Label Indicator	18-29
18.5.10 Text Indicator	18-30
18.5.11 Image Indicator	18-31
18.5.12 Overlay Screen	18-32
18.5.13 Library Image	18-33
18.5.14 Trend Graph	18-34
18.5.15 Line Graph	18-37
18.5.16 Ascii	18-39
18.6 Data transfer objects	18-42
18.6.1 Assignment of function keys	18-42
18.6.2 Touch Key	18-43
18.6.3 Switch	18-47
18.6.4 Send Data Bank (recipe function)	18-49
18.6.5 Write Constant	18-50
18.6.6 Increment	18-51
18.6.7 Decrement	18-52
18.6.8 Data Setting	18-53
18.6.9 Keyboard	18-56
18.6.10 Change Screen	18-60
18.6.11 Alarm history display function	18-61
18.6.12 Alarm list display function	18-63
18.6.13 Buzzer	18-66
18.7 Text library	18-67
18.8 Image library	18-68
18.9 Data file	18-69
18.10 Setting of backlight (F920GOT-K)	18-71
18.11 Assignment of LEDs (F930GOT-K)	18-72

19.Changeover of Display Screen (FX-PCS-DU/WIN-E).....	19-1
19.1 Outline of changeover of display screen	19-1
19.2 "Change Screen" object.....	19-2
19.2.1 Contents of setting	19-2
19.2.2 Operation of screen changeover	19-4
19.2.3 Timing of screen changeover	19-5
19.3 Screen changeover by touch key	19-6
19.4 Screen changeover using function keys	19-9
19.5 Screen changeover from PLC	19-11
19.5.1 Screen changeover using bit devices.....	19-11
19.5.2 Screen changeover by data register	19-12
19.6 Screen changeover by screen number stored in memory	19-14
19.7 Changeover to system screen	19-16
19.7.1 Display of system screen	19-16
19.8 Application of screen changeover	19-17
20.Creation of Display Screen (GT Designer).....	20-1
20.1 Project auxiliary settings.....	20-1
20.2 Parts list.....	20-8
20.3 Application and setting item.....	20-10
20.4 Figure display function.....	20-12
20.5 Data display function	20-13
20.5.1 Display of numerics	20-13
20.5.2 Ascii display.....	20-15
20.5.3 Clock display	20-18
20.6 Message display function	20-19
20.6.1 Comment display.....	20-19
20.6.2 Alarm history display	20-20
20.6.3 Alarm list display	20-23
20.7 Animation display function.....	20-25
20.7.1 Part display.....	20-25
20.7.2 Lamp	20-26
20.7.3 Panel meter	20-27
20.8 Graph display function	20-28
20.8.1 Line graph	20-29
20.8.2 Trend graph.....	20-30
20.8.3 Bar graph.....	20-31
20.8.4 Statistics graph display function	20-33
20.9 Touch keys	20-34
20.9.1 Common items for all touch keys	20-35
20.9.2 Bit function.....	20-37
20.9.3 Word function	20-39
20.9.4 Creation of keys to enter numerics and ASCII codes.....	20-40
20.10 Operation panel	20-41
20.10.1 Assignment of function keys	20-42
20.11 Data input function	20-43
20.11.1 Numerical input function	20-43
20.11.2 Ascii code input function	20-45
20.12 Creation of comment.....	20-48
20.13 Recipe function	20-49
20.14 Setting of backlight (F920GOT-K).....	20-51
20.15 Assignment of LEDs (F930GOT-K)	20-52

21.Changeover of Display Screen (GT Designer).....	21-1
21.1 Outline of changeover of display screen	21-1
21.2 Changeover of display screen	21-2
21.2.1 Contents of setting	21-2
21.2.2 Contents of screen changeover operation	21-2
21.3 Changeover of base screen (changeover from PLC)	21-3
21.3.1 Outline of changeover of base screen.....	21-3
21.3.2 Example of base screen changeover	21-4
21.4 Screen changeover by touch key or function key	21-5
21.4.1 Changeover using a fixed value	21-5
21.4.2 Changeover to Previous screens	21-6
21.5 Changeover to system screen.....	21-8
21.5.1 Display example of system screen.....	21-8
21.6 Application of screen changeover	21-9
21.6.1 Application example 1	21-9
21.6.2 Application example 2	21-11
22.Appendix	22-1
22.1 Number of registered screen construction elements	22-1
22.2 Comparison with screen creation software.....	22-3
22.3 Differences in functions among display units and connected PLC.....	22-5
22.4 Key pad operation on system screens (F930GOT-K)	22-9
22.5 System Screen Number	22-10
22.6 Key Code List	22-11
22.7 Device Name Which Can Be Monitored	22-12
22.7.1 Devices in GOT-F900.....	22-12
22.7.2 PLC by Mitsubishi.....	22-14
22.7.3 PLC Units Manufactured by Other Companies	22-19
22.8 Key Code List	22-27
22.9 Label pattern (F930GOT-K).....	22-29

Manual configuration and various data

The table below shows the manual configuration related to the graphic operation terminal GOT-F900.

Manual name	Manual number	Description
F920GOT-BBD5-K-E Installation Manual (included with product)	JY992D02201	This manual contains explanations for the specifications, installation and maintenance, etc of F920GOT-BBD5-K-E graphic operation terminals.
F930GOT-BBD5-K-E Installation Manual (included with product)	JY992D02501	This manual contains explanations for the specifications, installation and maintenance, etc of F930GOT-BBD5-K-E graphic operation terminals.
F930GOT Series (F93*GOT-BWD-E) Installation Manual (included with product)	JY992D95701	This manual contains explanations for the specifications, installation and maintenance, etc. of F930GOT Series graphic operation terminals.
F940GOT Series (F940GOT-*WD-E) Installation Manual (included with product)	JY992D94201	This manual contains explanations for the specifications, installation and maintenance, etc of F940GOT Series graphic operation terminals.
F940GOT Handy Series (F94*GOT-*BD-H-E) HARDWARE MANUAL (included with product)	JY992D86901	This manual contains explanations for the specifications, installation and maintenance, etc of F940GOT Handy Series handy graphic operation terminals.
F940WGOT Series Installation Manual (included with product)	JY992D93901	This manual contains explanations for the specifications, installation and maintenance, etc of F940WGOT Series graphic operation terminals.
SW□D5C-GOTR-PACKE OPERATING MANUAL (included with screen creation software)	—	This manual contains explanations for the operation of GT Designer (SW*D5C-GOTR-PACKE) screen creation software.
FX-PCS-DU/WIN-E SOFTWARE MANUAL (included with screen creation software)	JY992D68301	This manual contains explanations for the operation of FX-PCS-DU/WIN-E screen creation software.
GOT-F900 SERIES OPERATION MANUAL (this manual)	JY992D94701	This manual contains explanations for the operation and use of the GOT-F900 Series graphic operation terminals.
GOT-F900 SERIES HARDWARE MANUAL (CONNECTION) (separate volume)	JY992D94801	This manual contains explanations for the wiring and installation, etc of the GOT-F900 series graphic operation terminals.
F9GT-40UMB MANUAL	JY992D74101	F9GT-40UMB HARDWARE MANUAL (packed together with product) Describes the operating procedure of the adapter for data transfer F9GT-40UMB.

MEMO

1. Introduction

This chapter describes the product and system configuration of the graphic operation terminal.

1.1 Outline

The graphic operation terminal (hereafter abbreviated to GOT) is to be mounted on the face of a control panel or operations panel, and connected to a programmable controller (hereafter abbreviated to PLC).

Various devices can be monitored and data can be changed in the PLC through the screens of the GOT.

There are several display screens built-in to the GOT which offer various functions. In addition user defined screens can be created.

The user defined screens (user screens) and the built-in screens (system screens) have the following respective functions.

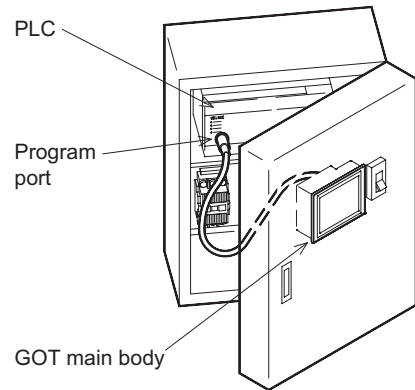

User screens

- Screen display function

The following functions can be assigned to each screen. Also the available screens can be limited using the security function.

Both software packages, FX-PCS-DU/WIN-E, and SW□D5C-GOTR-PACKE ("□" indicates a numeric not less than "1".) can be used to create user screens.

Display function

- Up to 500 user defined screens can be displayed. In screen creation, two or more screens can be overlaid or changed over arbitrarily.
- Simple graphics such as straight lines, circles and rectangles can be displayed, along with numerics and English, Japanese, Chinese and Korean text. Also bitmaps can be imported and displayed as well as pre-defined screen components.

Monitor function

- Set values and current values of word devices in the PLC can be displayed in numerics or bar graphs for monitoring.
- The specified range of the screen components can be displayed in reverse in accordance with the ON/OFF status of bit devices in the PLC.

Data change function

- The numeric data being monitored can be changed.

Switch function

- By manipulating the operation keys in the GOT, bit devices in the PLC can be set to ON and OFF.
The display panel face can be assigned as touch keys to offer switch functions.

System screens

- Monitor function

List program (only in the FX Series)

- Programs can be read, written and monitored in the form of an instruction list program. (Available only in the F940GOT and F940WGOT)

Buffer memory (only in the FX2N and FX2NC Series)

- The contents of buffer memories (BFMs) of special blocks can be read, written and monitored. (Available only in the F940GOT and F940WGOT)

Device monitor

- The ON/OFF status of each device, the set value and current value of each timer, counter and data register in the PLC can be monitored and changed.
- Specified bit devices can be forced ON or OFF.
Unlike the monitor function described previously, screen data can be displayed by inputting a desired device number from the keyboard.

- Data sampling function

The current value of specified data registers are acquired in a constant cycle or when the trigger condition is satisfied.

- Sampling data can be displayed in the form of list or graph.
- Sampling data can be output to a printer in the form of list.

- Alarm function

Alarm messages can be assigned to up to 256 consecutive bit devices in the PLC (32 in the F920GOT-K). When a bit device becomes ON, the assigned message is displayed (overlapped) on the user screen.

In addition, a specified user screen can be displayed by setting a corresponding bit device to ON.

- When a bit device becomes ON, a corresponding message is displayed on the user screen. The message list can also be displayed.
- Up to 1000 alarms (turning ON of bit devices) can be stored as the alarm history. *1
- The alarm frequency of each device can be stored as historical data.

*1 Using the screen creation software, the alarm history can be read by a personal computer and then sent to a printer.

- Other functions

Many other functions are built in.

- A real-time clock, current time and data can be set and displayed (excluding the F920GOT-K).
- The GOT can function as an interface to enable data communication between the PLC and a personal computer in which the relay ladder creation software is operating. At this time, the GOT screen can also be displayed.
- The screen contrast and the buzzer sound volume can be adjusted.

1.2 Format of manual

1.2.1 Contents described in manual

This manual is described in the following format. Use each element of the format for index.

Example:

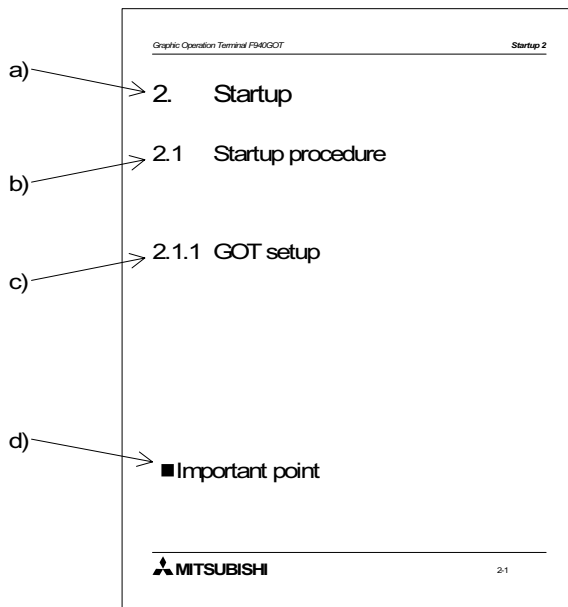

- a) Chapter title
Chapter 1 to 16 describe operations. Chapter 17 to 20 describe the contents required to create screens.
- b) Title
The title explains the contents of each section.
- c) Sub title
- d) Important point
Terms used in the text are explained and supplemented.

1.2.2 Abbreviations used in text

The following terms may be abbreviated in the text.

- 1) MELSEC FX Series, A Series, QnA Series, Q Series programmable controllers and programmable controllers by other companies may be abbreviated to "PLC".
- 2) The software kit to create display screens FX-PCS-DU/WIN-E or GT Designer may be abbreviated to "screen creation software".
- 3) A general-purpose computer may be abbreviated to "PC".
- 4) A floppy disk may be abbreviated to "FD". A floppy disk drive may be abbreviated to "FDD".
- 5) The graphic operation terminal GOT-F900 Series may be abbreviated to "GOT".
- 6) Devices inside the PLC may be abbreviated to "X" (input), "Y" (output), "M" (auxiliary relay), "S" (state), "T" (timer), "C" (counter) and "D" (data register). Output contacts of X,Y, M, S, T and C are called "bit devices". T, C and D are called "word devices". All of them may be called "devices".

Abbreviation of model name

This manual describes the explanation related to the following products.

Each product is classified by the functions, and written as "F930GOT/F933GOT/F940GOT/F943GOT/F940WGOT/handy GOT".

(The display unit in the handy GOT has the functions similar to those in the F940GOT or the F943GOT. Unless otherwise specified, read the explanation of the F940GOT or the F943GOT as the explanation of the handy GOT.)

Abbreviation	F920GOT-K	F930GOT-K	F930GOT	F933GOT
Model name	F920GOT-BBD5-K-E	F930GOT-BBD-K-E	F930GOT-BWD-E	F933GOT-BWD

Abbreviation	F940GOT	F943GOT	F940WGOT	Handy GOT
Model name	F940GOT-SWD-E F940GOT-LWD-E	F943GOT-LWD F943GOT-SWD	F940WGOT-TWD-E	F940GOT-SBD-H-E F940GOT-LBD-H-E F943GOT-SBD-H-E F943GOT-LBD-H-E F940GOT-SBD-RH-E F940GOT-LBD-RH-E F943GOT-SBD-RH-E F943GOT-LBD-RH-E

- "GOT with a key-pad" is the generic name for the F920GOT-BBD5-K-E and F930GOT-BBD-K-E display units.
- The display unit in the F940GOT-LBD-H-E and the F940GOT-LBD-RH-E has the functions similar to those in the F940GOT-LWD-E.
In this manual, the F940GOT-LBD-H-E and the F940GOT-LBD-RH-E are described as the F940GOT or the F940GOT-LWD-E unless otherwise specified.
- The display unit in the F940GOT-SBD-H-E and the F940GOT-SBD-RH-E has the functions similar to those in the F940GOT-SWD-E.
In this manual, the F940GOT-SBD-H-E and the F940GOT-SBD-RH-E are described as the F940GOT or the F940GOT-SWD-E unless otherwise specified.
- The display unit in the F943GOT-LBD-H-E and the F943GOT-LBD-RH-E has the functions similar to those in the F943GOT-LWD.
In this manual, the F943GOT-LBD-H-E and the F943GOT-LBD-RH-E are described as the F943GOT or the F943GOT-LWD unless otherwise specified.
- The display unit in the F943GOT-SBD-H-E and the F943GOT-SBD-RH-E has the functions similar to those in the F943GOT-SWD.
In this manual, the F943GOT-SBD-H-E and the F943GOT-SBD-RH-E are described as the F943GOT or the F943GOT-SWD unless otherwise specified.

1.3 Expressions and basic functions of operation keys

The operation keys are expressed as follows in the text.

The examples of the screen display and key operation are described using the F940GOT if not specified.

1.3.1 Expressions of operation keys

- 1) Touch keys on the screen which are actuated when being touched by fingers are enclosed with a frame.

USER SCREEN MODE , PROGRAM LIST

- 2) Cursor control keys to be pressed may be expressed as follows.

▲ , ▼ → ▲, ▼

- 3) When a same key is pressed several times or a same operation is repeated, the following expression may be used.

▲ , MORE

- 4) When an arbitrary numeric within the range of 0 to 9 is to be entered, the following expression may be used.

0 to 9

1.3.2 Basic operations

The common operations in the GOT are shown below.

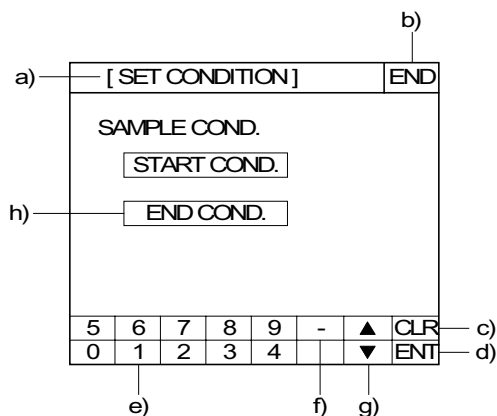

- a) Function display
The selected mode or function is displayed here.
- b) END key
This key terminates the displayed function, and returns to the previous screen.
- c) CLR (clear) key
This key cancels the input of characters and numeric values.
- d) ENT (enter) key
This key determines the input of alphabets and numerics.
- e) Ten-key keypad
This keypad allows to enter numerics.
- f) - (minus) key
- g) ▲ and ▼ (cursor control) keys
- h) Touch key for item setting
Displays a set item or keyboard for numeric input in accordance with the contents of display.

1.4 System configuration

The method of connecting the GOT to PLC and peripheral units is described below.

1.4.1 Connection of GOT with peripheral units

The figure below shows the system configuration required to use the GOT with peripheral units.

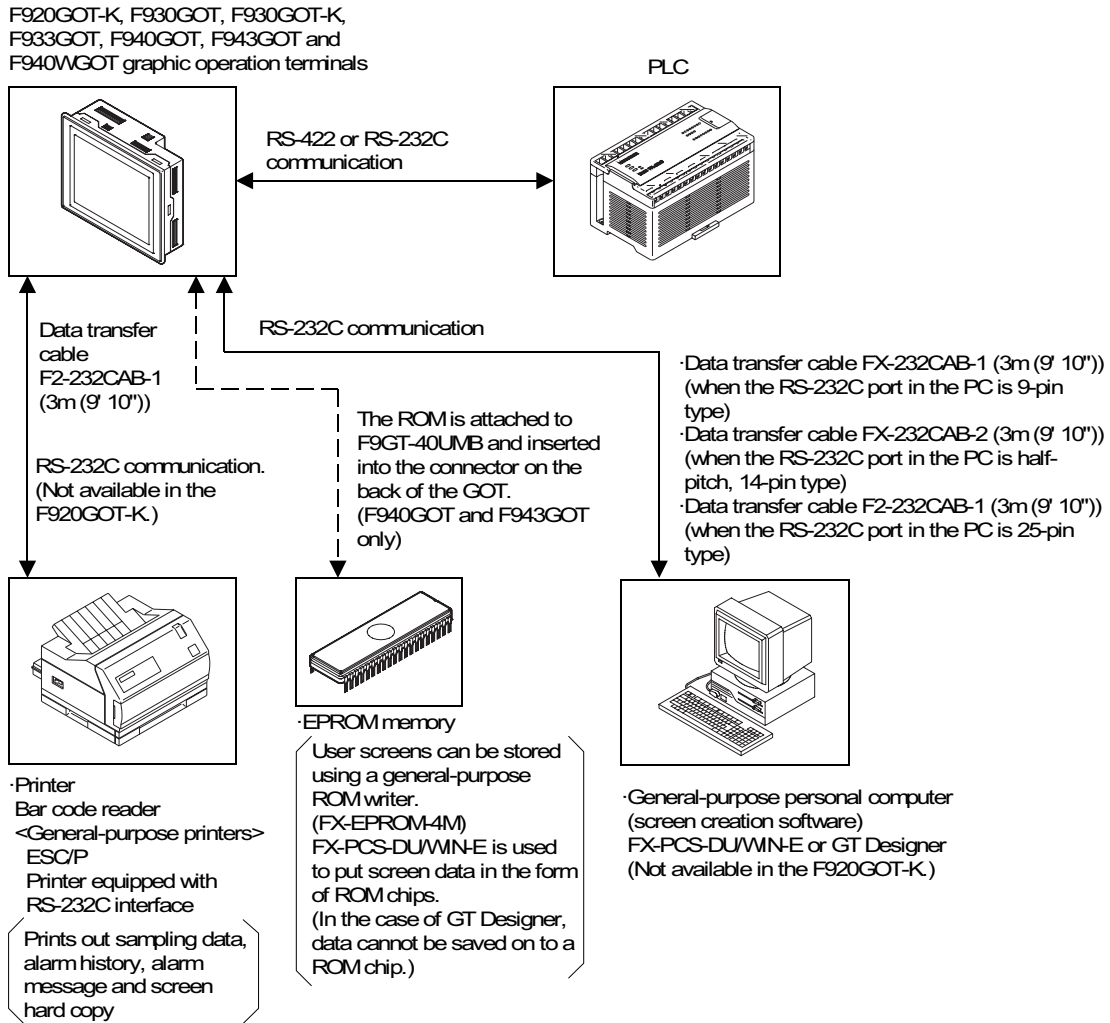

**DANGER**

- Do not edit the PLC program simultaneously using multiple peripheral equipment (programming tool and GOT).
Otherwise, the PLC may produce improper operating signals or the program may be damaged.

**CAUTION**

- When concurrently using multiple peripheral equipment (programming tool and GOT), edit the PLC program using individual tools. The edited PLC program must be displayed or read out from the unit unused for editing. If the PLC program is carelessly edited using multiple peripheral equipment, thus, PLC and each unit has differing programs, the PLC may execute unintended operations when program or set values for timer/counters is changed next time.

- A CPU connection with the A, QnA, or Q Series PLC allows for sequence programs to be transferred and monitored using the FX-PCS/WIN-E or GX Developer software connected with a personal computer (2-port interface function).
When communicating with a QnA or Q series PLC the 2-port interface function can be used when the GOT is set for CPU connection.
(The 2-port interface function is valid in the GOT920GOT-K-E only for CPU connection with the FX Series PLC. This function cannot be used in any GOT when connected to a PLC manufactured by other companies.)
When using the GOT and peripheral devices dedicated to sequence program editing (such as FX-20P and A6GPP that performs RS-422 communication) for the one PLC, connect the GOT to an extension communication board or extension communication adapter for the FX Series, a computer link unit of A Series or a communication unit for the QnA Series or Q Series.

1.5 Applicable PLC

Setting of the PLC to be connected is made according to "PLC TYPE" in "SET-UP MODE (see Section 7.2)".

✓: Possible to connect ✕: Impossible to connect

F920GOT-K

Applicable PLC	Direct connection to CPU		Computer link Upper link		Remarks
	RS-232C	RS-422	RS-232C	RS-422	
MELSEC FX Series manufactured by Mitsubishi Electric	✕	✓	✕	✕	Any version may be used. Connection via function expansion board for RS422 communication is available.
MELSEC A Series manufactured by Mitsubishi Electric	✕	✓	✕	✕	Any version may be used.
MELSEC QnA Series manufactured by Mitsubishi Electric	✕	✓	✕	✕	Any version may be used.
MELSEC Q Series manufactured by Mitsubishi Electric	✓	✕	✕	✕	Any version may be used. • Including Q multi CPU system: Q02CPU, Q02HCPU, Q06HCPU, Q12HCPU, Q25HCPU

F930GOT-K/F930GOT/F933GOT/F940GOT/F943GOT/F940WGOT

Applicable PLC	Direct connection to CPU		Computer link Upper link		Remarks
	RS-232C	RS-422	RS-232C	RS-422	
MELSEC FX Series manufactured by Mitsubishi Electric	✓*1	✓	✕	✕	For connection to FX1S and FX1N Series, the following versions should be used. F930GOT and F933GOT, V2.10 or later should be used. F930GOT-K any version may be used. F940GOT and F943GOT, V4.00 or later should be used. F940WGOT, any version may be used.
MELSEC A Series manufactured by Mitsubishi Electric	✕	✓	✓	✓	Any version may be used.

Applicable PLC	Direct connection to CPU		Computer link Upper link		Remarks
	RS-232C	RS-422	RS-232C	RS-422	
MELSEC QnA Series manufactured by Mitsubishi Electric	✗	✓	✓*2	✓*2	F930GOT and F933GOT, V2.00 or later should be used. F930GOT-K any version may be used. F940GOT and F943GOT, V3.00 or later should be used. (When a version is former than V3.00 and computer link connection is made, only setting for computer link for A Series is available.) F940WGOT, any version may be used.
MELSEC Q Series manufactured by Mitsubishi Electric	✓	✗	✓*2	✓*2	F930GOT and F933GOT, V2.20 or later should be used. F930GOT-K any version may be used. F940GOT and F943GOT, V4.10 or later should be used. F940WGOT, any version may be used. For connection to Q00JCPU, Q00CPU and Q01CPU the following versions should be used. F930GOT and F933GOT, V4.3 or later should be used. F940GOT and F943GOT, V6.3 or later should be used. F940WGOT, V1.30 or later should be used.
Q multi-CPU system Q02CPU, Q02HCPU, Q06HCPU, Q12HCPU, Q25HCPU	✓	✗	✓*2	✓*2	F930GOT and F933GOT, V4.30 or later should be used. F930GOT-K any version may be used. F940GOT, and F943GOT, V6.30 or later should be used. F940WGOT, V1.30 or later should be used.
MELSEC FX-10GM, FX-20GM, E-20GM, FX _{2N} -10GM, FX _{2N} -20GM positioning units	✗	✓	✗	✗	F930GOT, V4.10 or later should be used. F930GOT-K any version may be used. F940GOT, V6.10 or later should be used. F940WGOT, V1.10 or later should be used.
Motion controllers A171SCPU-S3, A171SHCPU, A172SHCPU and A272UHCPU	✗	✓	✗	✗	Any version may be used.

Applicable PLC	Direct connection to CPU		Computer link Upper link		Remarks
	RS-232C	RS-422	RS-232C	RS-422	
Inverter FREQROL-A500, E500 and S500 Series manufactured by Mitsubishi Electric	x	✓	x	x	F930GOT, V4.10 or later should be used. F930GOT-K any version may be used. F940GOT, V6.10 or later should be used. F940WGOT, V1.10 or later should be used.
SYSMAC C Series manufactured by OMRON Corporation	x	x	✓	✓	Any version may be used.
FLEX-PC N Series manufactured by FUJI ELECTRIC CO., LTD.	x	x	✓	✓	Any version may be used.
FP Series FP0 and FP2SH manufactured by Matsushita Electric Works, LTD.	✓	x	x	x	F930GOT and F933GOT, V4.10 or later should be used. F930GOT-K any version may be used. F940GOT and F943GOT, V6.10 or later should be used. F940WGOT, V1.10 or later should be used.
Machine controllers CP9200SH, MP920 and MP930 manufactured by YASKAWA Electric Corporation	✓	✓	x	x	F930GOT and F933GOT, V3.00 or later should be used. F930GOT-K any version may be used. F940GOT and F943GOT, V5.00 or later should be used. F940WGOT, any version may be used.
SLC500 Series manufactured by Allen-Bradley Co., Inc.	✓	x	x	x	F930GOT and F933GOT, V2.00 or later should be used. F930GOT-K any version may be used. F940GOT and F943GOT, V5.00 or later should be used. F940WGOT, any version may be used.
MicroLogix 1000/1200/1500 Series manufactured by Allen-Bradley Co., Inc.	✓	x	x	x	F930GOT and F933GOT, V4.00 or later should be used. F930GOT-K any version may be used. F940GOT and F943GOT, V5.00 or later should be used. F940WGOT, any version may be used.

Applicable PLC	Direct connection to CPU		Computer link Upper link		Remarks
	RS-232C	RS-422	RS-232C	RS-422	
S7-200/300/400 Series manufactured by Siemens AG	✓	✗	✗	✗	The S7-300/400 is supported in the following versions. F930GOT and F933GOT, V3.00 or later should be used. F930GOT-K any version may be used. F940GOT and F943GOT, V5.00 or later should be used. F940WGOT, any version may be used. Following versions should be used for S7-200: F930GOT and F933GOT, V4.30 or later F930GOT-K any version may be used. F940GOT, and F943GOT, V6.30 or later F940WGOT, V1.30 or later
Microcomputer board	Select a communication procedure according to the GOT (RS-232C/RS-422).				When connecting two or more units F930GOT and F933GOT, V3.00 or later should be used. F930GOT-K any version may be used. F940GOT and F943GOT, V5.00 or later should be used. F940WGOT, any version may be used.

*1 When using the communication unit, use it with the setting of CPU direct connection.

*2 Set to Direct connection to CPU when using the communication unit.

- In the case of F933GOT and F943GOT, connection to a PLC is limited to RS-232C communication.
Be careful when looking at the table.
- For the method of wiring to a PLC, refer to "GOT-F900 SERIES HARDWARE MANUAL (CONNECTION)".

1.6 GOT version upgrade history

F920GOT-K

Version	Description
V1.00	• First version

F930GOT-K

Version	Description
V1.00	• First version

F930GOT and F933GOT

Version	Description
V1.00	<ul style="list-style-type: none"> • First version
V2.00	<ul style="list-style-type: none"> • Addition of function, connecting to QnA Series PLC • Addition of function, bar code connection • Addition of function, observe status • Touch key and lamp graphic extension • Compatible with SLC500 Series manufactured by Allen-Bradley Co., Inc. • Addition of rectangle and circle daubing pattern
V2.10	<ul style="list-style-type: none"> • Addition of function, connecting to two or more units for microcomputer board connection
V2.20	<ul style="list-style-type: none"> • Addition of function, connecting to Q Series PLC
V3.00	<ul style="list-style-type: none"> • Addition of function, connecting to S7-300/400 Series manufactured by Siemens AG • Addition of function, connecting to machine controller manufactured by YASKAWA Electric Corporation
V4.00	<ul style="list-style-type: none"> • Addition of function, connecting to MicroLogix 1000/1200/1500 Series manufactured by Allen-Bradley Co., Inc. • Addition of function, connecting to CS1 Series (CS1G/H-CPU□□-V1) manufactured by OMRON Corporation (Connection condition: Link connection) • Addition of function, entering numeric values including decimal points • Addition of security function (screen protection)
V4.20	<ul style="list-style-type: none"> • Addition of function, connecting to MELSEC positioning units FX-10/20GM, FX_{2N}-10/20GM, E-20GM • Addition of function, connecting to inverter FREQROL-A500, E500 and S500 Series • Addition of function, connecting to FP0 and FP2SH Series manufactured by Matsushita Electric Works, LTD. • Addition of function, connecting to S7-200 Series manufactured by Siemens AG • Addition of function, displaying alarms in alarm list in order of occurrence • Addition of function, high-definition font display • Addition of function, "6dots × 8dots" font display • Coping with customizing of key window
V4.30	<ul style="list-style-type: none"> • Addition of function, connecting to Q00JCPU, Q00CPU and Q01CPU • Addition of function, connecting to Q multi-CPU system (Q02CPU, Q02HCPU, Q06HCPU, Q12HCPU and Q25HCPU) • Addition of function, uploading recipe data by screen creation software • Addition of function, vertical display capability
V4.40	<ul style="list-style-type: none"> • Addition of function, buzzer sounds by GOT bit device (GB) • Change in ON/OFF process for bit devices, when connecting to PLCs manufactured by Omron Corporation
V4.50	<ul style="list-style-type: none"> • The key code (FFFE) to mute the buzzer sound of touch keys is added. • Communication commands available while the microcomputer board is connected are added: Command to write two or more points in the unit of bit Command to fill the internal data (D, M)

F940GOT and F943GOT (including Handy GOT)

Version	Description
V1.00	<ul style="list-style-type: none"> • First version
V1.10	<ul style="list-style-type: none"> • Compatible with QnA Series (A Series mode) • Compatible with GT Designer.
V2.00	<ul style="list-style-type: none"> • Compatible with SLC500 Series manufactured by Allen-Bradley Co., Inc. • Addition of function of bar code connection
V3.00	<ul style="list-style-type: none"> • Addition of function, connecting to QnA Series PLC • Addition of hard-copy function • Addition of setting of key window initial display position • Addition of key code for alarm history
V3.10	<ul style="list-style-type: none"> • Addition of observe status function • Compatible with customizing of key window • Touch key and lamp graphic extension • Addition of rectangle and circle daubing pattern
V4.00	<ul style="list-style-type: none"> • Addition of function, connecting to FX_{1S} and FX_{1N} Series PLC
V4.10	<ul style="list-style-type: none"> • Addition of function, connecting to Q Series PLC
V5.00	<ul style="list-style-type: none"> • Addition of function, connecting to S7-300/400 Series manufactured by Siemens AG • Addition of function, connecting to machine controller manufactured by YASKAWA Electric Corporation
V6.00	<ul style="list-style-type: none"> • Addition of function, connecting to MicroLogix 1000/1200/1500 Series manufactured by Allen-Bradley Co., Inc. • Addition of function, connecting to CS1 Series (CS1G/H-CPU□□-V1) manufactured by OMRON Corporation (Connection condition: Link connection) • Addition of function, entering numeric values including decimal points • Addition of security function (screen protection)
V6.20	<ul style="list-style-type: none"> • Addition of function, connecting to MELSEC positioning units FX-10/20GM, FX_{2N}-10/20GM, E-20GM • Addition of function, connecting to inverter FREQROL-A500, E500 and S500 Series • Addition of function, connecting to FP0 and FP2SH Series manufactured by Matsushita Electric Works • Addition of function, connecting to S7-200 Series manufactured by Siemens AG • Addition of function, displaying alarms in alarm list in order of occurrence • Addition of function, high-definition font display • Addition of function, "6dots × 8dots" font display
V6.30	<ul style="list-style-type: none"> • Addition of function, connecting to Q00JCPU, Q00CPU and Q01CPU • Addition of function, connecting to Q multi-CPU system (Q02CPU, Q02HCPU, Q06HCPU, Q12HCPU and Q25HCPU) • Addition of function, uploading recipe data by screen creation software • Addition of instructions, in HPP mode (FNC156 ABS, FNC169 HOUR, FNC176 RD3A, FNC177 WR3A and FNC180 EXTR) • Addition of FX_{2N}-8AD and FX_{2N}-2LC buffer memory access
V6.40	<ul style="list-style-type: none"> • Addition of function, buzzer sounds by GOT bit device (GB) • Change in ON/OFF process for bit devices, when connecting to PLCs manufactured by OMRON Corporation
V6.50	<ul style="list-style-type: none"> • The key code (FFFE) to mute the buzzer sound of touch keys is added. • Communication commands available while the microcomputer board is connected are added: Command to write two or more points in the unit of bit Command to fill the internal data (D, M)

F940WGOT

Version	Description
V1.00	<ul style="list-style-type: none"> • First version
V1.10	<ul style="list-style-type: none"> • Addition of function, connecting to MELSEC positioning units FX-10/20GM, FX_{2N}-10/20GM, E-20GM • Addition of function, connecting to inverter FREQROL-A500, E500 and S500 Series • Addition of function, connecting to FP0 and FP2SH Series manufactured by Matsushita Electric Works • Addition of function, displaying alarms in alarm list in order of occurrence • Addition of function, high-definition font display • Addition of function, "6dots × 8dots" font display
V1.30	<ul style="list-style-type: none"> • Addition of function, connecting to Q00JCPU, Q00CPU and Q01CPU • Addition of function, connecting to Q multi-CPU system (Q02CPU, Q02HCPU, Q06HCPU, Q12HCPU and Q25HCPU) • Addition of function, connecting to S7-200 Series manufactured by Siemens AG • Addition of function, uploading recipe data by screen creation software • Addition of instructions, in HPP mode (FNC156 ABS, FNC169 HOUR, FNC176 RD3A, FNC177 WR3A and FNC180 EXTR) • Addition of FX_{2N}-8AD and FX_{2N}-2LC buffer memory access
V1.40	<ul style="list-style-type: none"> • Addition of function, buzzer sounds by GOT bit device (GB) • Change in ON/OFF process for bit devices, when connecting to PLCs manufactured by OMRON Corporation
V1.50	<ul style="list-style-type: none"> • The key code (FFFE) to mute the buzzer sound of touch keys is added. • Communication commands available while the microcomputer board is connected are added: Command to write two or more points in the unit of bit Command to fill the internal data (D, M)

1.7 Screen creation software version upgrade history

The following software is used to create display screens.

FX-PCS-DU/WIN-E

Version	Description
V1.00	<ul style="list-style-type: none"> • First version (not compatible with F900 Series GOT)
V2.00	<ul style="list-style-type: none"> • Addition of function, programming F940GOT • Addition of setting, display of line graph (batch) object and outer frame • Addition of key code for alarm history
V2.10	<ul style="list-style-type: none"> • Compatible with label color inversion of lamp (label) and touch key on black-and-white liquid crystal display unit • Addition of function, programming Handy GOT
V2.20	<ul style="list-style-type: none"> • Addition of function, programming F930GOT and F933GOT display unit • Improving of graphic size (320 × 240 dots) registered in image library • Addition of function, connecting to bar code reader
V2.30	<ul style="list-style-type: none"> • Addition of function, connecting to QnA Series PLC • Addition of function, connecting to SLC500 Series manufactured by Allen-Bradley Co., Inc. • Addition of function, hard-copy setting on F940GOT display screen • Addition of graphic type to touch key and lamp (label) object
V2.41	<ul style="list-style-type: none"> • Addition of hatching pattern of rectangle and circle object • Addition of line type, straight line and rectangle object • Compatible with European font display • Addition of function, connecting to Q Series PLC • Addition of function, connecting to S7-300/400 Series manufactured by Siemens AG • Addition of alarm list and alarm history object • Addition of display, alarm mode flow
V2.50	<ul style="list-style-type: none"> • Addition of function, programming F940WGOT display unit. • Addition of PLC applicable to GOT MELSEC positioning unit FX-10/20GM, FX₂N-10/20GM, E-20GM, FREQROL A500, E500, S500 Series Extension of support device of SLC500 Series manufactured by Allen-Bradley Co., Inc. MicroLogix Series manufactured by Allen-Bradley Co., Inc. • Addition of setting, observe status function • Compatible with high-definition font display • Compatible with "6 × 8 dots" font display • Addition of GOT-F900 internal device (GB, GD)
V2.52	<ul style="list-style-type: none"> • Addition of function of connecting to S7-200 Series manufactured by Siemens AG
V2.60	<ul style="list-style-type: none"> • Addition of PLC applicable to GOT Q00JCPU, Q00CPU and Q01CPU FP Series manufactured by Matsushita Electric Works, LTD. • Improvement of security function • Addition of function, vertical display capability in F930GOT • Compatible with Windows (R) Me
V2.70	<ul style="list-style-type: none"> • Compatible with F920GOT-BBD5-K and F930GOT-BBD-K

GT Designer (Main items relating to F900 Series GOT)

SW□ : Abbreviation of SW□D5C-GOTR-PACKE

(A), (B)... : Abbreviation of screen creation software package version name

Version	Description
SW0D5C(A)	<ul style="list-style-type: none"> First version (not compatible with F900 Series GOT)
SW1D5C(E)	<ul style="list-style-type: none"> Usable for F940GOT (Usable for F940GOT whose main unit version is V1.10 or later) Addition of function, connecting to C Series manufactured by OMRON Corporation Addition of function, connecting to microcomputer
SW1D5C(H)	<ul style="list-style-type: none"> Usable for F930GOT and F933GOT Addition of function, connecting to bar code reader Addition of function, connecting to SLC500 Series manufactured by Allen-Bradley Co., Inc.
SW2D5C(A)	<ul style="list-style-type: none"> Addition of hard-copy function
SW5D5C(F) V5.05F	<ul style="list-style-type: none"> Compatible with connecting to MicroLogix 1000/1200/1500 Series manufactured by Allen-Bradley Co., Inc. Compatible with connecting to CS1 Series (CS1G/H-CPU□□-V1) manufactured by OMRON Corporation
SW5D5C(K) V5.09K	<ul style="list-style-type: none"> Compatible with connecting to MELSEC positioning units FX-10/ 20GM, FX_{2N}-10/ 20GM and E-20GM Compatible with connecting to FREQROL A500, E500 and S500 Series Compatible with connecting to FP Series manufactured by Matsushita Electric Works Compatible with high-definition font display Compatible with "6 × 8 dots" font display
SW5D5C(P) V5.13P	<ul style="list-style-type: none"> Addition of PLC applicable to GOT Q00JCPU, Q00CPU and Q01CPU Q multi-CPU system (Q02CPU, Q02HCPU, Q06HCPU, Q12HCPU and Q25HCPU) S7-200 Series manufactured by Siemens AG Addition of function, vertical display capability in F930GOT
SW5D5C V5.26C	<ul style="list-style-type: none"> Compatible with F920GOT-K and F930GOT-K

- The items shown above are main items relating to F900 Series GOT.
For further details about the version upgrade of each piece of software, refer to the corresponding operation manual (operating manual).
GT Designer can be used to create screens for the F940GOT version 1.10 or later.
GT Designer version SW1D5C(A) or later can be used to create screens for all versions of GOTs other than the F940GOT.

1.8 Preservation of screen data and backup

The undermentioned data is stored in RAM of GOT or the flash memory.

RAM area:

Data is backed up with the built in battery. (The F920GOT-K is equipped with the EEPROM.)

- 1) System settings, recipe (recipe data), and current time set by GOT main unit are stored in RAM (a) below
- 2) Alarm data and sampling data are stored in RAM (b) below

Flash memory area: Battery is unnecessary.

- 3) Data made with screen creation software
Screen data, recipe (recipe data, recipe conditions), alarm conditions, sampling conditions and system settings

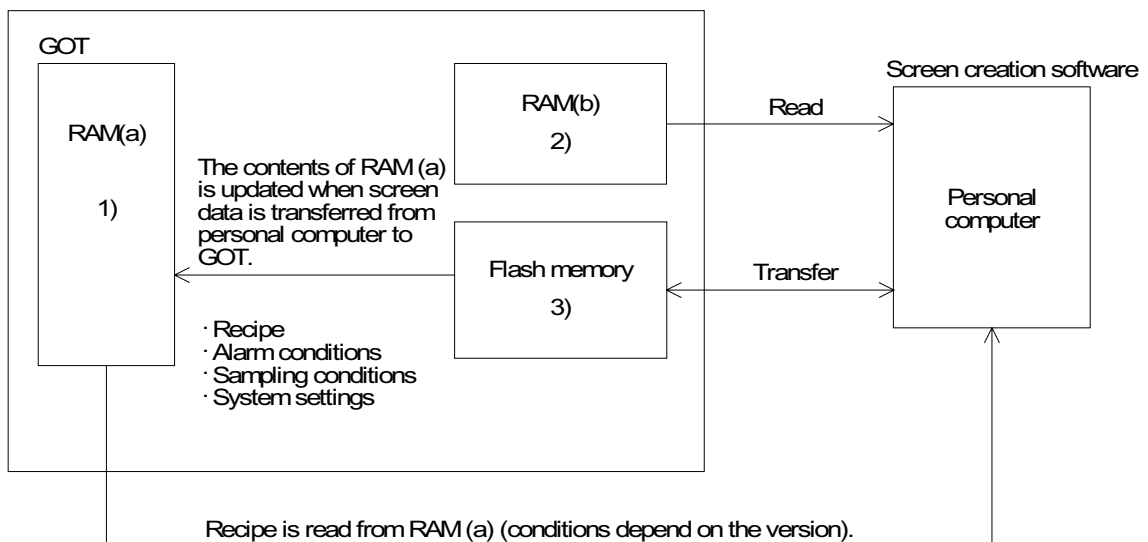

- Transfer between the screen creation software and GOT is done between RAM (b) (except current time) or flash memory.

When screen data is read from the GOT versions listed below to a personal computer, screen data, alarm conditions, sampling conditions, and system settings are read from the flash memory while recipe data is read from RAM (a).

(In earlier GOT versions, recipe data is stored to/read from the flash memory.)

F920GOT-K, F930GOT-K	: First product
F930GOT, F933GOT	: V4.30 or later
F940GOT, F943GOT	: V6.30 or later
F940WGOT	: V1.30 or later

- The system settings can be set with the GOT main unit (stored in RAM (a)) or the screen creation software (stored in flash memory after transferred). The content set later is given priority.
If system settings are set by the GOT main unit, it is stored in RAM (a) so that data may be lost if the backup battery power runs out. In this situation, it may not be possible to communicate with the programmable controller.
If possible set the system settings in the screen creation software.
(If data in RAM (a) is lost, the data in the flash memory will be written to RAM (a) automatically)
The F920GOT-K is equipped with an EEPROM, therefore, no data is lost due to a drop in battery voltage.
EEPROM can be overwritten 10000 times.

2. Specifications

For the power supply specifications, outside dimensions and installation, refer to "GOT-F900 SERIES HARDWARE MANUAL (CONNECTION)".

2.1 General specifications

Item	Specifications					
Temperature	Use: 0 to 50°C (32 to 122°F) (0 to 40°C when using an extension interface or for Handy GOT) Storage: -20 to 60°C (-4 to 140°F) In the case of F940WGOT, ambient temperature should be 0 to 50°C for vertical mounting; 0 to 40°C for horizontal mounting.					
Humidity	Use: 35 to 85%RH (non-condensing)					
Vibration resistance	Conforms to IEC 61131-2		Frequency	Acceleration	Amplitude (half)	10 times in each of X, Y and Z directions (for 80 minutes)
		With intermittent vibration	10 to 57Hz	—	0.075mm	
		With continuous vibration	57 to 150Hz	9.8m/s ²	—	
			10 to 57Hz	—	0.035mm	
57 to 150Hz	4.9m/s ²	—				
Shock resistance	Conforms to IEC 61131-2 (147m/s ² , 3 times in each direction X, Y and Z)					
Noise resistance	1,000Vp-p, 1μs, 30 to 100Hz, tested by noise simulator.					
Withstand voltage	500V AC for 1 min			Tested between power terminals and ground		
Insulation resistance	5MΩ or more at 500V DC					
Grounding	Class D (100Ω or less)					
Working atmosphere	No corrosive gas and no significant dust					
Protective structure	IP65f (Handy GOT: IP54) *1					

*1 The relevancy is confirmed in the test for IP65f or IP54. However, this test result does not provide any guarantee that the product withstands use in all types of environments.

2.2 Display section specifications

F920GOT-K

Item		Specifications
		F920GOT-BBD5-K
Display element	LCD type	STN-type full dot matrix LCD
	Dot pitch Horizontal × Vertical (mm)	0.47 × 0.47
	Display color	Monochrome (Blue/White)
Screen		"128 × 64 dots" liquid crystal Valid display dimension: 60 × 30 mm (3"-type)
Display language	System language	Japanese and English (Japanese can be selected as system language only while Japanese is selected as user screen language.)
	User screen language	Japanese, English, Korean, Italian, Dutch, Swedish, Spanish, Danish, German, Portuguese and French Start up FX-PCS-DU/WIN-E or GT Designer (SW(D5C-GOTR-PACKE) on OS (Windows) compatible with each language, then create screens.
Life of liquid crystal		Approximately 50,000 hours (Ordinary temperature: 25°C/77°F, Ordinary humidity) Guaranteed term is 1 year.
Backlight		LED Color changeover (white/red) is available.
Touch key		No touch key
Key-pad		Ten-key keypad, cursor key, function keys (6), SET/DEV/ENT keys 26 keys in total
Interface	RS-422	In conformity with RS-422 standard, 1 channel and for PLC communication
	RS-232C	In conformity with RS-232C standard, 1 channel and for screen data transfer or Q Series PLC communication
Number of screens		User created screen: Max. 500 screens FX-PCS-DU/WIN-E: No.0 to No.499 GT Designer: No.1 to No.500 System screen: 12 screens (Screen number: No. 1001 to No. 1030)
User memory		Flash memory 128KB

F930GOT/F933GOT/F930GOT-K

Item		Specifications	
		F930GOT-BWD F933GOT-BWD	F930GOT-BBD-K
Display element	LCD type	STN-type full dot matrix LCD	
	Dot pitch Horizontal × Vertical (mm)	0.47 × 0.47	
	Display color	Monochrome (Blue/White)	
Screen		"240 × 80 dots" liquid crystal Valid display dimension: 117 × 42 mm (3"-type)	
Display language	System language	Japanese and English (Japanese can be selected as system language only while Japanese is selected as user screen language.)	
	User screen language	Japanese, English, Korean, Italian, Dutch, Swedish, Spanish, Danish, German, Portuguese and French Start up FX-PCS-DU/WIN-E or GT Designer (SW(D5C-GOTR-PACKE) on OS (Windows) compatible with each language, then create screens.	
Life of liquid crystal		Approximately 50,000 hours (Ordinary temperature: 25°C/77°F, Ordinary humidity) Guaranteed term is 1 year.	
Backlight		Cold cathode (life of 50,000 hours or more at 25°C/77°F) Guaranteed term is 1 year.	
Touch key	Number of keys used	Max. 50 keys/1 screen	
	Configuration (Horizontal × Vertical)	"15 × 4" matrix configuration	
Key-pad		No key-pad	Ten-key keypad, cursor key, function keys (6), SET/DEV/ENT keys 26 keys in total
Interface	RS-422	In conformity with RS-422 standard, 1 channel and for PLC communication (F933GOT and F943GOT have no RS-422 port.)	
	RS-232C	In conformity with RS-232C standard, 1-channel and for screen data transfer. (F933GOT and F943GOT: In conformity with RS-232C standard, 2 channel and for screen data transfer and for PLC communication)	
Number of screens		User created screen: Max. 500 screens FX-PCS-DU/WIN-E: No.0 to No.499 GT Designer: No.1 to No.500 System screen: 25 screens (Screen number: No. 1001 to No. 1030)	
User memory		Flash memory 256KB	

F940GOT/F943GOT/F940WGOT

Item		Specifications		
		F940GOT-LWD F943GOT-LWD	F940GOT-LWD F943GOT-LWD	F940WGOT-TWD
Display element	LCD type	STN-type full dot matrix LCD		TFT-type full dot matrix LCD
	Dot pitch Horizontal × Vertical (mm)	0.36 × 0.36		0.324 × 0.375 *1
	Display color	Monochrome (Blue/White)	8 colors	256 colors
Screen		"240 × 80 dots" liquid crystal Valid display dimension: 117 × 42 mm (3"-type)		"480 × 234 dots" liquid crystal Valid display dimension: 115.5 × 87.8 mm (7"-type)
Display language	System language	Japanese and English (Japanese can be selected as system language only while Japanese is selected as user screen language.)		
	User screen language	Japanese, English, Korean, Chinese (Simplified), Chinese (Traditional), Italian, Dutch, Swedish, Spanish, Danish, German, Portuguese and French Start up FX-PCS-DU/WIN-E or GT Designer (SW(D5C-GOTR-PACKE) on OS (Windows) compatible with each language, then create screens.		
Life of liquid crystal		Approximately 50,000 hours (Ordinary temperature: 25°C/77°F, Ordinary humidity) Guaranteed term is 1 year.		
Backlight		Cold cathode (life of 40,000 hours or more at 25°C/77°F)		Cold cathode (life of 50,000 hours or more at 25°C/77°F)
		Guaranteed term is 1 year.		
Touch key	Number of keys used	Max. 50 keys/1 screen		
	Configuration (Horizontal × Vertical)	"20 × 12" matrix configuration		"30 × 12" matrix configuration (last column composed of 14 dots)
Key-pad		No key-pad		
Interface	RS-422	In conformity with RS-422 standard, 1 channel and for PLC communication (F933GOT and F943GOT have no RS-422 port.)		
	RS-232C	In conformity with RS-232C standard, 1-channel and for screen data transfer. (F933GOT and F943GOT: In conformity with RS-232C standard, 2 channel and for screen data transfer and for PLC communication)		In conformity with RS-232C standard, 2-channel and for screen data transfer and for PLC communication
Number of screens		User created screen: Max. 500 screens FX-PCS-DU/WIN-E: No.0 to No.499 GT Designer: No.1 to No.500 System screen: 30 screens (Screen number: No. 1001 to No. 1030)		
User memory		Flash memory 512KB		Flash memory 1KB

*1 Displayed items have a length to height ratio of about 1: 1.16.

3. Name of Display Unit

This section describes the name and the role of the display unit in the GOT.
 For the operation switch and the grip switch in the handy GOT, refer to "GOT-F900 SERIES HARDWARE MANUAL (CONNECTION)".

3.1 Front panel

1) Display

- F920GOT-K
 "128 × 64 dots" graphic display
 Character string : 16 characters × 4 lines
 The backlight changeover is available (white/red).
 For settings, refer to Section 19.10 and 21.14.
- F930GOT, F933GOT, F930GOT-K (Horizontal display only)
 "240 × 80 dots" graphic display
 Character string :30 characters × 5 lines / Horizontal display
 10 characters × 15 lines / Vertical display
- F940GOT, F943GOT
 "320 × 240 dots" graphic display
 Character string: 40 characters × 15 lines
- F940WGOT
 "480 × 234 dots" graphic display
 Character string:
 60 characters × 14 lines / Horizontal display
 29 characters × 30 lines / Vertical display

<Example>
 F940GOT

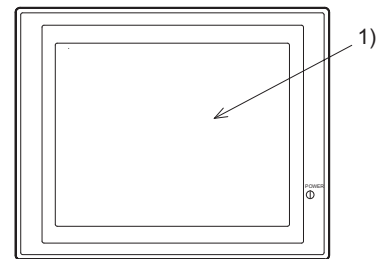

2) Function keys

- F920GOT-K ... Six membrane switches (without green LED)
 - F930GOT-K ... Eight membrane switches with green LED
- Using the screen creation software, set the operation of each function key and alternate the status of each LED.
 (Refer to Section 17)

F920GOT-K

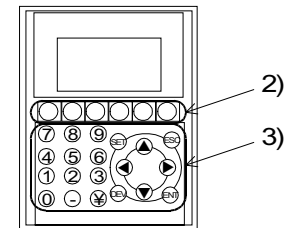

F930GOT-K

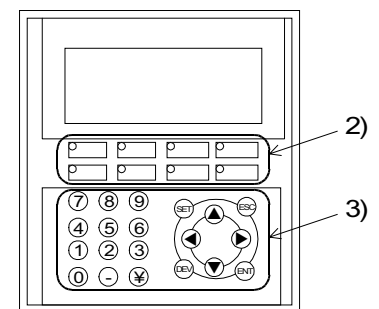

- 3) Ten-keys, cursor control keys, "SET" key, "DEV" key, "ESC" key and "ENT" key
- F920GOT-K and F930GOT-K
 - Ten-keys "0" to "9", "-" and "."
Used to enter a numeric value in the data input operation.
 - Cursor control keys. . . "<" , ">" , "▲" and "▼"
Used to move the cursor in the data input operation.
 - "SET" key Used to display the cursor in the data input operation.
 - "DEV" key Used to enter devices on DEVICE MONITOR screen (system screen).
Also used in the F920GOT-K to change over the display from a user screen to a system screen.
 - "ESC" key Used to cancel the data input operation.
(Also used to exit a system screen in the F920GOT-K.)
 - "ENT" key Used to determine an input numeric value in the data input operation.
 - The function keys in the F930GOT-K are used for switches, data inputs and screen changeover on user screens.
The ten-keys, the cursor control keys, the "SET" key, the "ESC" key and the "ENT" key are mainly used to change the data in "Numerical Input" and "Ascii Input". Set these keys using the touch keys while a system screen is displayed. (Some keys are valid even while a system screen is displayed. Refer to section 22.4.)

3.2 Rear panel

F920GOT-K

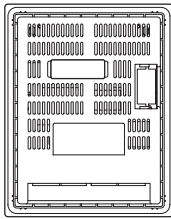

F930GOT-K

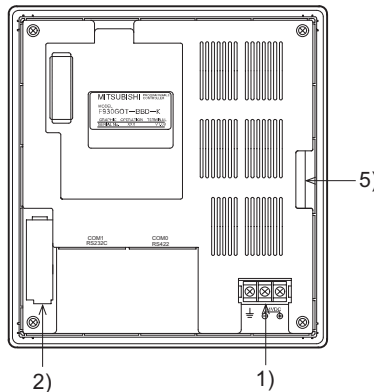

F930GOT, F933GOT

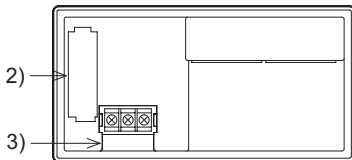

F940GOT, F943GOT

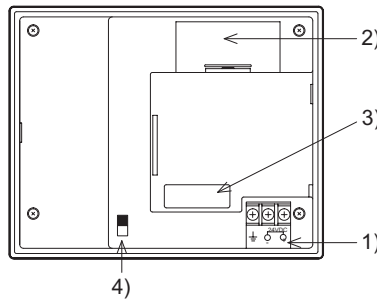

F940WGOT

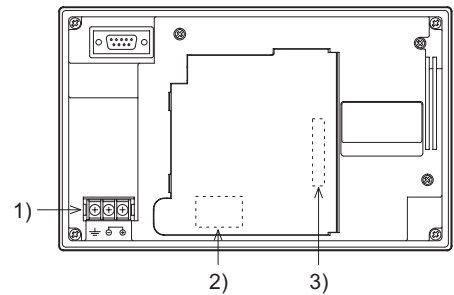

- 1) Power terminal : Supply power to the GOT and for grounding.
The F920GOT-K 5V power is supplied from the PLC via cable.
- 2) Battery : Store sampling data, alarm history and the current time.
Screen data is stored in the built-in flash memory, for which no battery power is needed.
Battery name
F920GOT-K is not mounted with a battery.
F930GOT/F933GOT/F930GOT-K . . . FX2NC-32BL
F940GOT/F943GOT/F940WGOT . . . PM-20BL
- 3) Extension interface : Connect optional extension devices.
A F9GT-40UMB type data transfer adapter is connected to transfer screen data stored in the EPROM.
The F9GT-40UMB and F9GT-40FMB are applicable to the F940GOT, F943GOT, and F940WGOT.
- 4) CN↔OP selector switch : Not used (F940GOT)
- 5) Name sheet : The arbitrary key names can be assigned to the function keys of the F930GOT-K.
An OHP transparent sheet is included with the product. Prepare a name sheet referring the dimension indicated in the Installation Manual offered with the product or Section 23.10 in this manual. (The name sheet is not provided in the GOT units other than F930GOT-K.)

3.3 Functions of ports

A PLC and peripheral devices are connected to the following ports of the GOT.

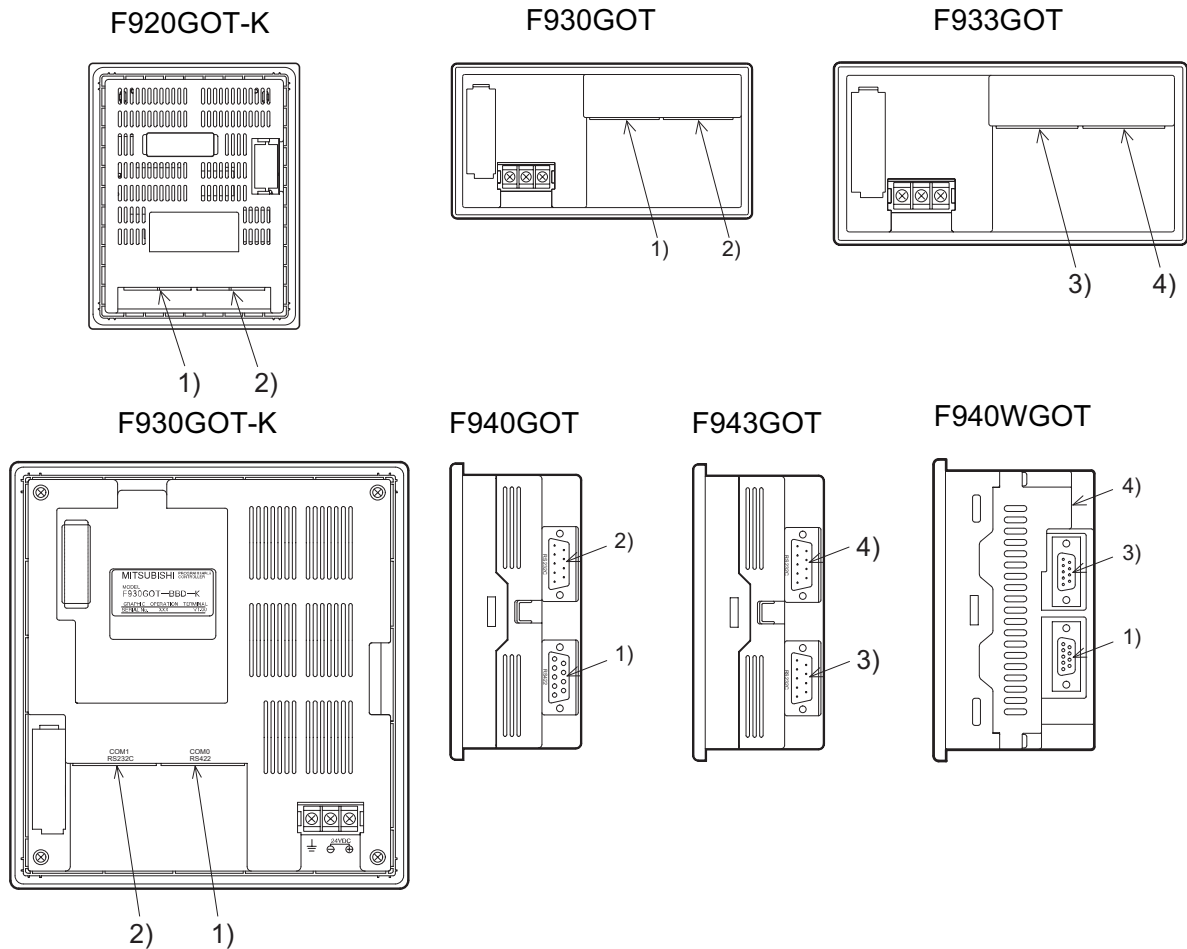

1) Port for PLC (RS-422 port) 9-pin D-Sub, female

- Used for RS-422 connection to a PLC.
- Also used to connect two or more GOT units (RS-422 connection). (Only one GOT can be connected to the F920GOT-K.)

2) Port for PC (RS-232C port) 9-pin D-Sub, male

- For connection to PC when transferring screen data created by the screen creation software.
- Used for RS-232C connection to a PLC or microcomputer board. (F920GOT-K is connected only to the Q Series PLC.)
- Also used to connect two or more GOT units (RS-232C connection) or for communication with bar code reader or printer. (The F920GOT-K cannot be connected with multiple GOT units, a bar code reader, or printer.)
- 2-port interface function can be used. (A PC on which the ladder support software has been opened can be connected.)

3) Port for PLC (RS-232C port) 9-pin D-Sub, male

- Used for RS-232C connection to a PLC or microcomputer board.
- Also used to connect two or more GOT units (RS-232C connection) or for communication with a bar code reader or printer.

4) Port for PC (RS-232C port) 9-pin D-Sub, male

- For connection to PC when transferring screen data created by the screen creation software.
- Not used for connection to a PLC.
- When the GOT is connected to a PLC through Port 3) (RS-232C), it can be used to connect two or more GOT units (RS-232C connection) or for communication with a bar code reader or printer.
- 2-port interface function can be used. (A PC on which the ladder support software has been opened can be connected.)
- For details of connection with a PLC, microcomputer board, or personal computer, refer to GOT-F900 SERIES HARDWARE MANUAL (CONNECTION) offered separately.

MEMO

4. Function

4.1 Function list

The functions of the GOT are divided into 6 modes. The operator can use each function by selecting the corresponding mode.

Mode	Function	Outline of function	Reference chapters
USER SCREEN MODE	Character display	<ul style="list-style-type: none"> Alphanumerics are displayed. 	7 19 21
	Drawing	<ul style="list-style-type: none"> Straight lines, circles and rectangles are displayed. 	
	Lamp display	<ul style="list-style-type: none"> The color of a specified area on the screen is inverted in accordance with the ON/OFF status of the bit devices in the PLC. 	
	Graphic display	<ul style="list-style-type: none"> Set values and current values of the word devices in the PLC can be displayed in the form of bar graph, line graph or panel meter. 	
	Data display	<ul style="list-style-type: none"> Set values and current values of the word devices in the PLC can be displayed in the form of numeric. 	
	Data change function	<ul style="list-style-type: none"> Current values and set values of the word devices in the PLC can be changed. 	
	Switch function	<ul style="list-style-type: none"> The ON/OFF status of bit devices in the PLC are controlled. Control can be in the format of momentary, alternate or set/reset. 	
	Screen changeover	<ul style="list-style-type: none"> The display screen can be changed over. The PLC or touch key can be used to change over the display screen. 	
	Data batch transfer	<ul style="list-style-type: none"> Data saved in the GOT can be transferred to the PLC. 	
	Security function	<ul style="list-style-type: none"> Screens are displayed only when the proper password is entered. (This function is available also in the system screens.) 	5
HPP MODE	Program (list) *1	<ul style="list-style-type: none"> Programs can be read/written/monitored in instruction list program format. 	8
	Parameter *1	<ul style="list-style-type: none"> Parameters for the program capacity, memory latch range, etc. can be read/written. 	
	BFM monitor *1	<ul style="list-style-type: none"> Buffer memories (BFM) in special blocks for the FX_{2N}/FX_{2NC} Series can be monitored, and their set values changed. 	
	Device monitor	<ul style="list-style-type: none"> The ON/OFF status of bit devices as well as current values and set values of word devices can be monitored using device numbers and comment expression. 	
	Current value/set value change	<ul style="list-style-type: none"> Current values and set values of word devices can be changed using device Nos. and comment expression. 	

Mode	Function	Outline of function	Reference chapters
HPP MODE	Forced ON/OFF	<ul style="list-style-type: none"> The bit devices in the PLC can be forced ON or OFF. 	8
	State monitor *1	<ul style="list-style-type: none"> State (S) numbers in the ON status are automatically displayed for monitoring (valid only when MELSEC FX Series is connected). 	
	PLC diagnosis *1	<ul style="list-style-type: none"> Error information in the PLC is read and displayed. 	
SAMPLING MODE	Condition setting	<ul style="list-style-type: none"> Conditions of up to four devices to be sampled, sampling start/end time, etc. are set. 	9
	Result display	<ul style="list-style-type: none"> The sampling result is displayed in the form of list or graph. 	
	Data clear	<ul style="list-style-type: none"> The sampling data is cleared. 	
ALARM MODE	List (status display)	<ul style="list-style-type: none"> The current alarms are displayed in the list in order of occurrence. 	10
	History	<ul style="list-style-type: none"> The alarm history is stored together with the event time, in order of occurrence. 	
	Frequency	<ul style="list-style-type: none"> The number of events of each alarm is stored. 	
	History clear	<ul style="list-style-type: none"> The alarm history is deleted. 	
TEST MODE	Screen list	<ul style="list-style-type: none"> User screens are displayed in order of screen number. 	11
	Data file	<ul style="list-style-type: none"> The data used in the recipe function (data file transfer function) is changed. 	
	Debug operation	<ul style="list-style-type: none"> The operations are checked to know whether key operations, screen changeover, etc. have been correctly performed on the displayed user screen. 	
	Communication monitor	<ul style="list-style-type: none"> The status of communication with the connected PLC is displayed. 	
OTHER MODE	Time switch	<ul style="list-style-type: none"> A specified bit device is turned ON/OFF at specified time. 	12
	PC transfer	<ul style="list-style-type: none"> The screen data, the data sampling result and the alarm history can be transferred between the GOT and the screen creation software. 	
	Printer output	<ul style="list-style-type: none"> The sampling result and the alarm history can be output to a printer. 	
	Entry code	<ul style="list-style-type: none"> The entry code to protect programs in the PLC can be registered. 	
	System setting	<ul style="list-style-type: none"> The initial setting can be specified for the system language, connected PLC, serial transfer, title screen, menu screen call, current time, backlight extinguishing time, buzzer volume, LCD contrast, screen data clear, etc. 	

*1 Only valid when connecting to the FX Series PLC.

Functions and applicable models

✓: Available

✗: Not available

Mode	Function	Model name			
		F920GOT-K	F930GOT-K F930GOT F933GOT	F940GOT F943GOT	F940WGOT
USER SCREEN MODE	Character display	✓	✓	✓	✓
	Drawing	✓	✓	✓	✓
	Lamp display	✓	✓	✓	✓
	Graphic display	✓	✓	✓	✓
	Data display	✓	✓	✓	✓
	Data change function	✓*1	✓*1	✓	✓
	Switch function	✓*1	✓*1	✓	✓
	Screen changeover	✓*1	✓*1	✓	✓
	Data batch transfer	✓*1	✓*1	✓	✓
	Security function	✓	✓	✓	✓
HPP MODE	Program (list)	✗	✗	✓	✓
	Parameter	✗	✗	✓	✓
	BFM monitor	✗	✗	✓	✓
	Device monitor	✓	✓	✓	✓
	Current value/ set value change	✓	✓	✓	✓
	Forced ON/OFF	✓	✓	✓	✓
	State monitor	✗	✓	✓	✓
	PLC diagnosis	✗	✓	✓	✓
SAMPLING MODE	Condition setting	✗	✗	✓	✓
	Result display	✗	✗	✓	✓
	Data clear	✗	✗	✓	✓
ALARM MODE	List (status display) *2	✗	✗	✓	✓
	History *2	✗	✗	✓	✓
	Frequency	✗	✗	✓	✓
	History clear	✗	✗	✓	✓

Mode	Function	Model name			
		F920GOT-K	F930GOT-K F930GOT F933GOT	F940GOT F943GOT	F940WGOT
TEST MODE	Screen list	✓	✓	✓	✓
	Data file	✓	✓	✓	✓
	Debug operation	✓	✓	✓	✓
	Communication monitor	✓	✓	✓	✓
OTHER MODE	Time switch	✓ ^{*3}	✓	✓	✓
	PC transfer	✗	✓	✓	✓
	Printer output	✗	✓	✓	✓
	Entry code	✓	✓	✓	✓
	System setting	✓	✓	✓	✓

- *1 When using the F920GOT-K, allocate each function to a function key.
When using the F930GOT-K, these functions can be allocated to either touch keys or function keys.
- *2 In the F920GOT-K, F930GOT-K, F930GOT, and F933GOT, ALARM MODE is not available on system screens, but the similar display is available in USER SCREEN MODE. The date and time is not displayed when using the Alarm list function in the F920GOT-K.
- *3 In the F920GOT-K, clock data of the PLC is displayed.
This function can be used only when connected to the PLC equipped with a clock function or either a memory cassette or memory board.

5. Start Up

This chapter describes the start up procedure from turning ON the power of the GOT to selection of the mode.

This chapter also describes the important system settings to be used in the GOT. Make sure to read this chapter carefully.

5.1 Start up procedure

This section describes the start up procedure from turning ON the power of the GOT to selection of the mode. In the F940WGOT, BRIGHTNESS is used instead of LCD CONTRAST.

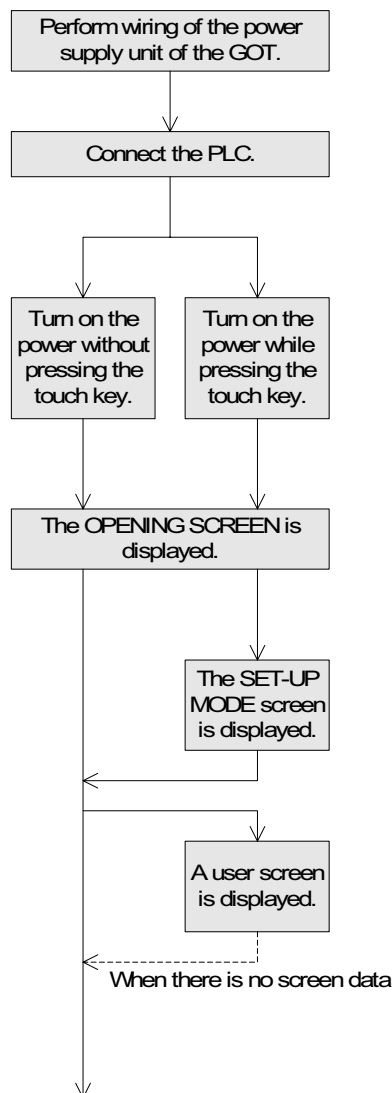

- Perform wiring of the power supply unit of the GOT.
- Connect the GOT and the PLC with an optional cable.
- Turn on the power of the GOT. When turning on the power, press and hold the top left hand corner of the GOT screen for more than 1 second if the SET-UP screen is required.
- The OPENING SCREEN indicating the model name, the version, etc. is displayed for the period set in "OPENING SCREEN" in the SET-UP MODE screen.
- In the SET-UP MODE screen, set the required mode, the connected PLC name, etc. The system setting can also be performed in the OTHER MODE screen.
- A user screen is displayed. If a user screen does not exist, then the SELECT MODE screen shown on the following page is displayed.

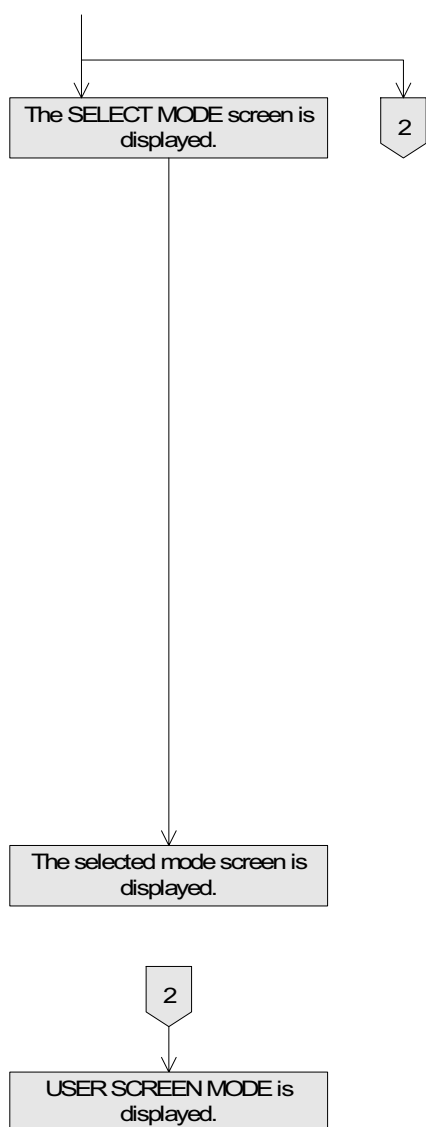

- The SELECT MODE screen is displayed. Each menu item on the screen functions as a touch key. When a desired one is pressed, the corresponding mode is selected.
- * This SELECT MODE screen can be called also by pressing a corner of the screen set in "MAIN MENU CALL KEY" on the SET-UP MODE screen.

[SELECT MODE]	
[SELECT MODE]	END
USER SCREEN MODE	
HPP MODE	
SAMPLING MODE	
ALARM MODE	
TEST MODE	
OTHER MODE	

- The selected mode screen is displayed.
- If the menu call key is not set in "MAIN MENU CALL KEY" on the SET-UP MODE screen, the USER SCREEN MODE is displayed.

5.2 System settings

5.2.1 Outline of operation environment setting

The system settings function configures the operation of the GOT. The SETUP MODE screen can be displayed by turning on the power while pressing and holding the upper left corner of the screen in accordance with the start-up procedure previously shown or by selecting OTHER MODE on the SELECT MODE screen.

If an entry code has been registered using the security function (to protect screens), the system settings can be set only when an entry code input by the user is equivalent to the registered entry code.

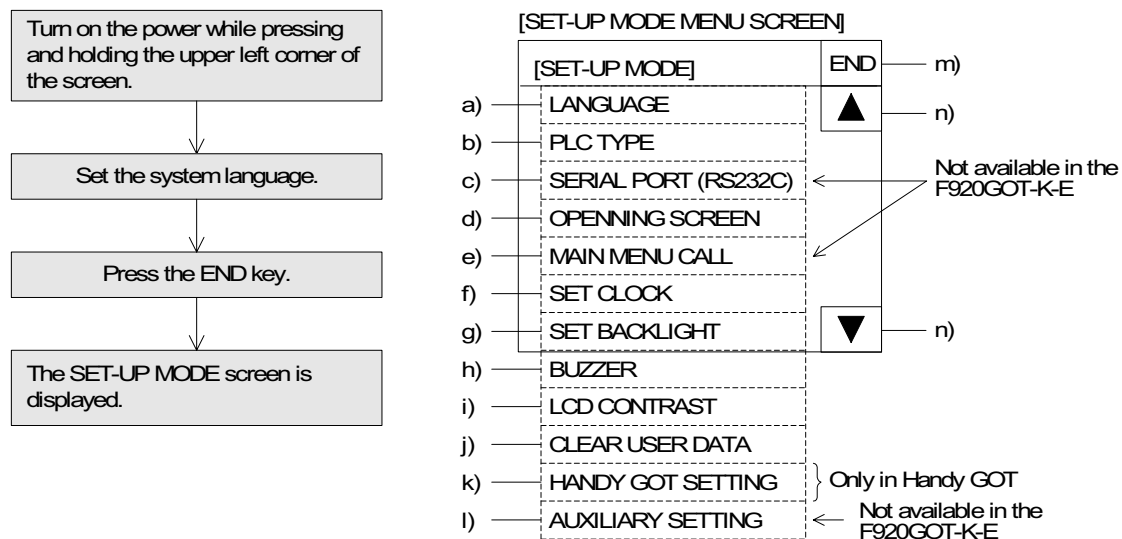

The areas enclosed with broken lines function as touch keys. (In the case of the F920GOT-K, operate the key-pad.)

a) LANGUAGE

Allows setting of the language displayed on the system screens such as Japanese or English.

When "CHARACTER SET" in "LANGUAGE" in "SET-UP MODE" is set to "WEST EUROPE", the following nine languages can be displayed: Italian, English, Dutch, Swedish, Spanish, Danish, German, Portuguese and French.

The system language is fixed to English.

In order to display either of the above languages, create screens using the screen creation software opened on the OS (Windows) compatible with the corresponding language.

The display of nine languages is provided in the following versions: F930GOT and F933GOT 2.10 or later, F940GOT and F943GOT 4.00 or later, F920GOT-K, F930GOT-K and F940WGOT.

b) PLC TYPE

Allows setting of the connected PLC type

c) SERIAL PORT (RS232C)

To be selected when a printer is connected to the GOT or when communication is performed between the GOT and a microcomputer board.

d) OPENING SCREEN

Allows setting of the duration in which the OPENING SCREEN is displayed immediately after the power is turned ON.

- e) MAIN MENU CALL KEY
Allows setting of the position of the touch key which calls the SELECT MODE screen from the USER SCREEN MODE
- f) SET CLOCK
Allows setting of the time used in the time switch and time display
- g) SET BACKLIGHT
Allows setting of the time the backlight is automatically turned OFF, after a period of continuous idle time
- h) BUZZER
Allows setting of the buzzer sound issued when a key is pressed
- i) LCD CONTRAST (F940WGOT: BRIGHTNESS)
Allows setting of the LCD brightness
- j) CLEAR USER DATA
Deletes all user screen data
- k) HANDY GOT SETTING
Allows setting of the grip switch or LED (Only in Handy GOT)
- l) AUXILIARY SETTING
Choose "WRITE" or "DOES NOT WRITE" for the initial display screen number to a PLC
- m) END
Exits the SET-UP MODE screen. SELECT MODE is displayed.
- n) Cursors
Change over the menu item on the SET-UP MODE screen

■ Important point

- When the items a) to e), g), h), k) and n) above are set in the GOT and screen data is transferred from the screen creation software, the system settings selected in the screen creation software becomes valid. In such a case, set the system settings in the GOT again or align from the beginning the setting of the items a) to e), g) and h) above with that in the screen creation software.
- A system setting with the GOT main unit is stored in RAM. (Refer to Section 1.8)
(When using the F920GOT-K, settings are stored in the EEPROM.)

5.2.2 LANGUAGE

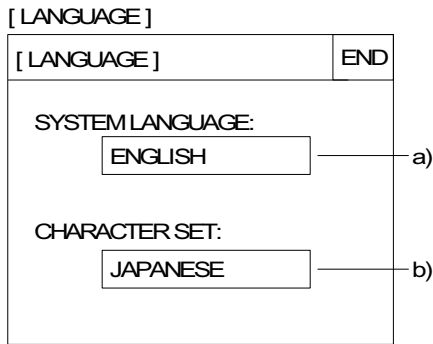

- Set the language used on the system screens and the user screens.
 - a) **SYSTEM LANGUAGE (Initial: ENGLISH)**
Allows setting of the language displayed on the system screens and in error messages. JAPANESE and ENGLISH are available.
 - b) **CHARACTER SET (Initial: JAPANESE)**
Allows setting of the language displayed on the user screens. JAPANESE, CHINESE and KOREAN are available. Only one language can be selected at a time. English character set is always available. When "CHARACTER SET" is set to "WEST EUROPE", the following nine languages can be displayed: Italian, English, Dutch, Swedish, Spanish, Danish, German, Portuguese and French. The system language is fixed to English. In order to display either of the above languages, create screens using the screen creation software opened on the OS (Windows) compatible with the corresponding language. The display of nine languages is provided in the following versions: F930GOT and F933GOT 2.10 or later, F940GOT and F943GOT 4.00 or later, all of F940WGOT.
- The areas on the screen enclosed with solid lines function as touch keys. Every time a touch key is pressed, the displayed contents are changed over. When using the F920GOT-K, operate the key-pad as follows:
 - Press the ▲/▼ key to move to the previous/next item.
 - Press the ► key to change the setting.
 - Press the ESC key to complete the setting.

5.2.3 PLC TYPE

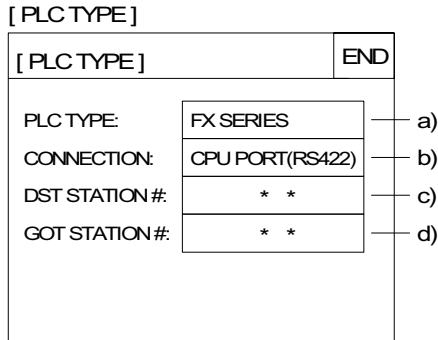

- Select the connected PLC type.

- a) PLC TYPE (Initial: FX SERIES)
Allows selection of a PLC to connect with the GOT
For the applicable PLCs, refer to Section 1.5.
- b) CONNECTION (Initial: CPU PORT(RS422))
Allows to set the connection method of the PLC selected in a).
 - CPU PORT (RS422):
The GOT is connected directly to the program port in the PLC (RS-422 or RS-232C).
 - LINK PORT (RS422):
The GOT performs RS-422 communication via a link unit.
 - LINK PORT (RS232C):
The GOT performs RS-232C communication via a link unit.
- c) DST STATION # (Initial: 00)
The displayed words differ according to the GOT versions.
- d) GOT STATION # (Initial: 00)
The displayed words differ according to the GOT versions.

- Select the connected PLC type.
When using the F920GOT-K, operate the key-pad as follows:
 - Press the ▲/▼ key to move to the previous/next item.
 - Press the ► key to change the setting.
 - Press the ESC key to complete the setting.
 In the F920GOT-K, station # is unavailable, and only the CPU PORT is available for CONNECTION.

5.2.4 SERIAL PORT

[SERIAL PORT]		END
SPEED:	9600 bps	
DATA BIT:	7 bit	
STOP BIT:	1 bit	
PARITY:	Even	
HANDSHAKING:	XON/XOFF	
PRINTER:	DONT USE	

- Set the serial communication parameters for the printer used to print out alarm messages and sampling data. (Initial: Left screen)
- Make sure to set "PRINTER" to "USE" when a printer is connected.
When it is set to "USE", the two-port interface function is not available.
- The area enclosed with broken lines function as touch keys. Every time a touch key is pressed, the displayed setting items change.
- When "LINK PORT (RS232C)" is selected on the PLC TYPE screen, a printer cannot be connected.
- A bar code reader can be connected. However, if a printer is connected, the computer link connection cannot be performed (RS232C).
- This item is not available in the F920GOT-K.

5.2.5 OPENING SCREEN

[OPENING SCREEN]		END					
[OPENING SCREEN]							
DISPLAY TIME: 4 SEC.							
5	6	7	8	9	-	▲	CLR
0	1	2	3	4		▼	ENT

- Set the duration in units of seconds in which the OPENING SCREEN indicating the model name, the version, etc. is displayed immediately after the power is turned on. (Initial: 4sec)
- When the touch key "DISPLAY TIME" is pressed, the time can be set using the ten-key pad displayed at the bottom of the screen.
- Enter the desired display time and press the ENT key to register the input time.
 - * If "DISPLAY TIME" is set to "0", the USER SCREEN MODE is displayed.
It is recommended to set 1 second or more for the FX Series and 4 seconds or more for the A Series.
- When using the F920GOT-K, operate the key-pad as follows:
 - Press the SET key to start making changes.
 - Press the 0 to 9 keys to enter time.
 - Press the ENT key to set time.
 - Press the ESC key to complete setting.

5.2.6 MAIN MENU CALL KEY

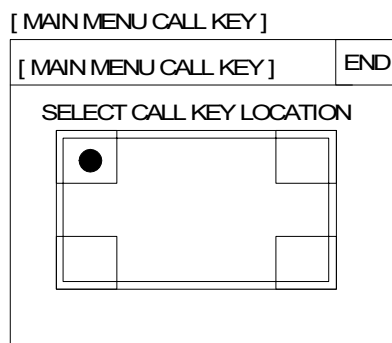

- Set the main menu call key which changes over USER SCREEN MODE to the SELECT MODE.
The main menu call key is mesh type, and 2 × 2 in size.
(Initial: On the left)
- One or two corners can be selected among the four corners of the screen.
- **When the main menu call key is not set, only the USER SCREEN MODE is available. Any other mode is not available.**
(In order to display the MAIN MENU, turn on the power again pressing the top left hand corner of the screen and hold it for more than 1 second.)
- If another touch key is assigned to the corners to which the main menu call key has been assigned, the menu call function is disabled.
- Manipulation of the key-pad is required in the F920GOT-K.

When the MAIN MENU CALL KEY is selected, VALID or INVALID is displayed. Press the ▲/▼ key to select either one and press the ESC key to exit the setting.

VALID: When the DEV key is pressed while a user screen is being displayed, the screen is changed over to the MAIN MENU.

INVALID: The screen is not changed over from a user screen to the MAIN MENU.
Turn on the power again pressing the DEV key for more than 1 second if the MAIN MENU screen is required.

5.2.7 SET CLOCK

[SET CLOCK]										END
DATE										3 / 1 / 1999
TIME										10: 10: 10
5	6	7	8	9	-	▲	CLR			
0	1	2	3	4		▼	ENT			

- Set the time used in the time switch, the sampling mode and the alarm mode.
- The clock data is not built in the F920GOT-K. On the SET CLOCK screen, set time from the clock data in the connected PLC. If the clock data does not exist in the PLC, a number 0 is displayed for each field.
- When "DATE" or "TIME" is selected, date or time can be entered using the ten-key pad displayed at the bottom of the screen. Enter the desired date or time and press the ENT key to register it.
- When using the F920GOT-K, operate the key-pad as follows:
 - Press the SET key to start making changes.
 - Press the ▲/▼/◀/▶ keys to move to another items.
 - Press the 0 to 9 keys to enter time.
 - Press the ENT key to set time.
 - Press the ESC key to complete setting.

5.2.8 SET BACKLIGHT

[SET BACKLIGHT]										END
OFF TIME										10 MIN.
5	6	7	8	9	-	▲	CLR			
0	1	2	3	4		▼	ENT			

- Set the time at which the display backlight turns off. When a touch key is not pressed or the user screen is not changed over within the specified OFF time, the backlight is turns off. (Initial: 10 min)
- When "OFF TIME" is pressed, the OFF time can be set within the range of 0 to 99 minutes using the ten-key pad displayed at the bottom of the screen. Enter the desired time and press the ENT key to register it.
- The life of the backlight is 25000 hours.
- The specified bit of the control device (system information) should be set to ON so that the backlight OFF function is enabled. (Refer to Section 6.6.)
- When using the F920GOT-K, operate the key-pad as follows:
 - Press the SET key to start making changes.
 - Press the 0 to 9 keys to enter time.
 - Press the ENT key to set time.
 - Press the ESC key to complete setting.

5.2.9 BUZZER

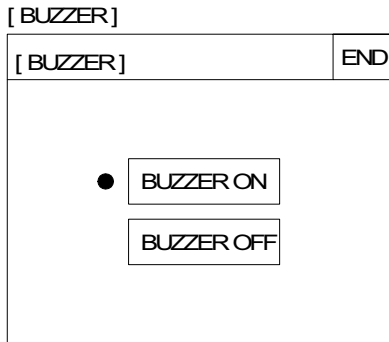

- Set whether or not the buzzer is to sound when a key is pressed or an error occurs.
- Select "BUZZER ON" or "BUZZER OFF".
- In the following GOT, muting of the buzzer sound can be set for each touch key by using the key code (FFFE) (This setting is unavailable in the F920GOT.).

Model	Applicable version
F930GOT, F933GOT	V4.50 and later
F930GOT-K	From first product
F940GOT, F943GOT (including ET and handy GOT)	V6.50 and later
F940WGOT	V1.50 and later

- When using the F920GOT-K, operate the key-pad as follows:
 - Press the ▲/▼ keys to move the cursor.
 - Press the ESC key to complete setting.

5.2.10 LCD CONTRAST

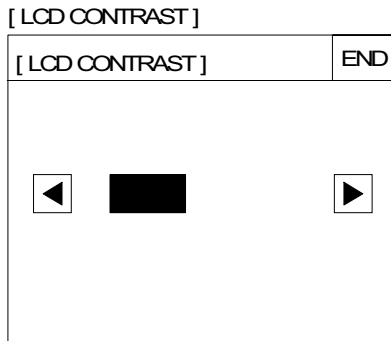

- The LCD brightness can be set in 15 steps. When the ◀ key is pressed, the LCD becomes darker. When the ▶ key is pressed, the LCD becomes brighter. (Initial: The middle)
In the F940WGOT, "BRIGHTNESS" can be set in 4 steps.
- When using the F920GOT-K, operate the key-pad as follows (Setting in ten scale):
 - Press the ◀/▶ keys to adjust the contrast.
 - Press the ESC key to complete setting.

5.2.11 CLEAR USER DATA

[CLEAR USER DATA]

[CLEAR USER DATA]	END
---------------------	-----

OK TO CLEAR USER DATA ?

YES
NO

- The screen data stored in the GOT can be cleared.
- When "YES" is selected, the message "NOW CLEARING USER DATA" is displayed and any key operations are not accepted.
- After that, the USER SCREEN MODE is automatically selected. The message "DISPLAY SCREEN IS NOT AVAILABLE" on the screen indicates the data has been cleared completely.
- When using the F920GOT-K, operate the key-pad as follows:
 - Press the ◀/▶ keys to adjust the contrast.
 - Press the ENT key to execute.
 - Press the ESC key to complete setting.

5.2.12 HANDY GOT SETTING

Setting the grip switch of the Handy GOT

```
[ HANDY GOT SETTING ]
[ HANDY GOT SETTING ] END
GRIP SWITCH:  DONT USE
PUSH BUTTON WRITE:
  DOES NOT WRITE
SWITCH OFF ACTION:
  TOUCH SWITCH OFF
LED ACTION:
  CONCURRENTLY WITH GRIP SWITCH
```

GRIP SWITCH

"USE" or "DON'T USE" can be chosen.

- If a screen is created whose version does not correspond to the Handy GOT, the grip switch is always valid on the screen.

PUSH BUTTON WRITE

Select the grip switch ON/OFF status in the "Interface Devices (FX-PCS-DU/WIN-E)" or "System Information (GT Designer)" menu by choosing "WRITE" or "DOES NOT WRITE".

- If "GRIP SWITCH" is set to "USE", "PUSH BUTTON WRITE" can be set to "WRITE" only.

SWITCH OFF ACTION

The SWITCH OFF ACTION can be selected if "GRIP SWITCH" is set to "USE".

LED ACTION

The LED ACTION can be selected if the "GRIP SWITCH" is set to "USE".

- For the details of the Handy GOT, refer to the GOT-F900 SERIES HARDWARE MANUAL (CONNECTION).

5.2.13 AUXILIARY SETTING

[AUXILIARY SETTING]	
[AUXILIARY SETTING]	END
INIT SCREEN NO:	WRITE

- The start-up screen in the GOT is numbered as follows.

- When created with FX-PCS-DU/WIN-E:
beginning with screen number 0
- When created with GT Designer:
beginning with screen number 1

If "WRITE" is selected when the GT Designer is used, "1" is written to the device specifying the base screen when the power is turned ON.

When specifying a screen to be displayed by using a program in the PLC when the PLC is changed over from the STOP status to the RUN status, select "NOT WRITE".

This function is invalid when the FX-PCS-DU/WIN-E is used.

- When using FX-PCS-DU/WIN-E, the setting in a common screen must be set up so that the screen change is always performed by PLC devices.
- This item is not available in the F920GOT-K.

5.3 Each mode selection procedure

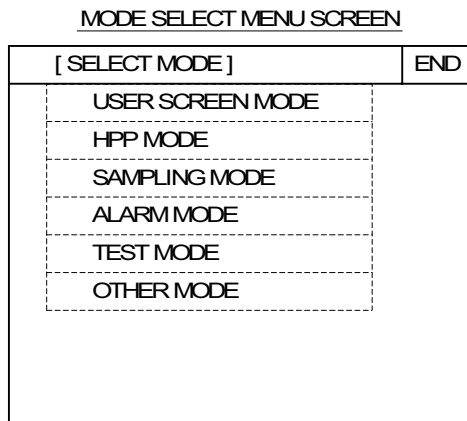

- If "MAIN MENU CALL KEY" has been set in "SET-UP MODE", when a specified touch key is pressed, the SELECT MODE screen shown on the left is displayed.
- When using the F920GOT-K, operate the keypad as follows:
 - Press the DEV key to display MODE SELECT MENU SCREEN.
- The outline of each mode and the selection procedure are described below.

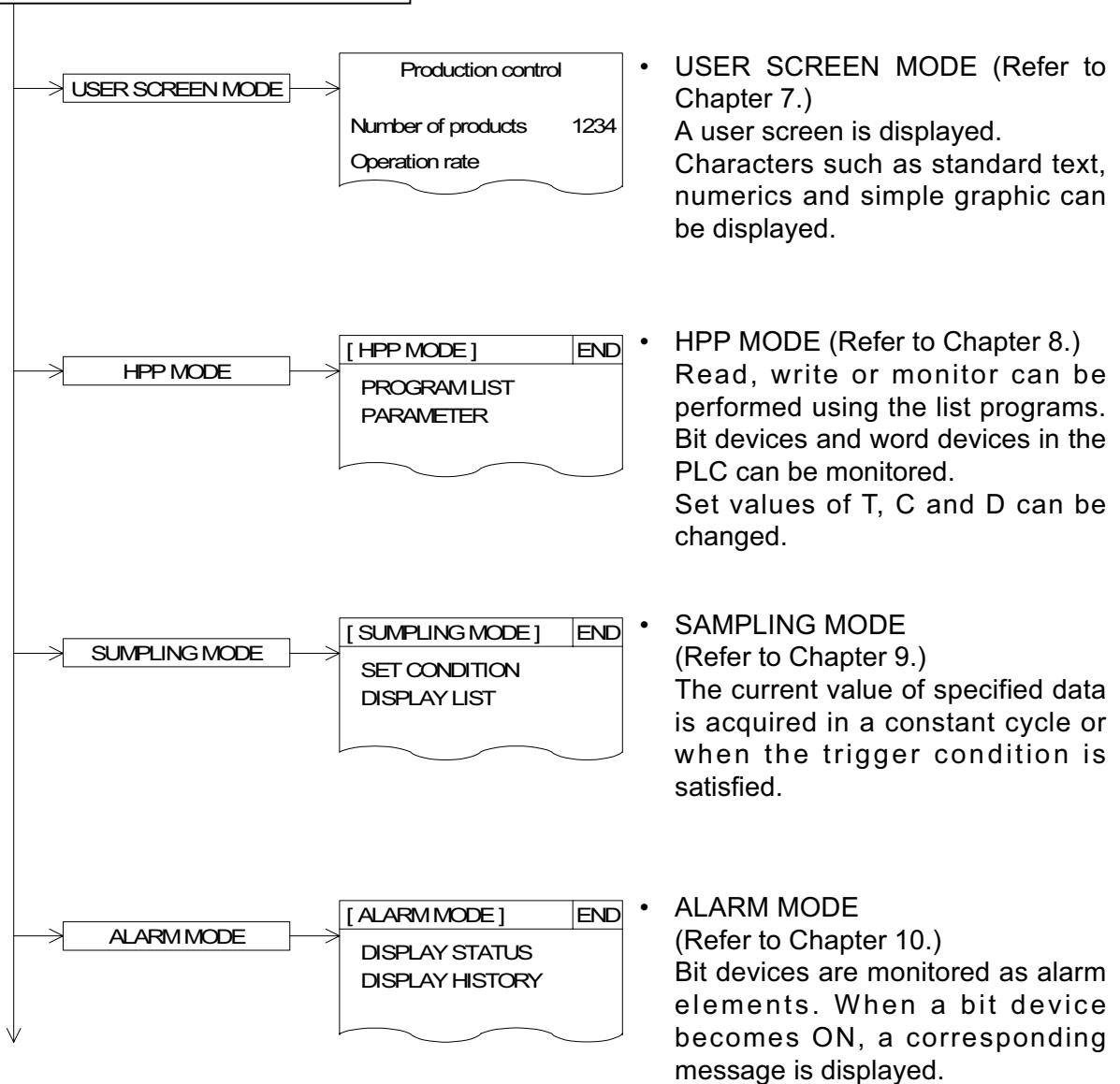

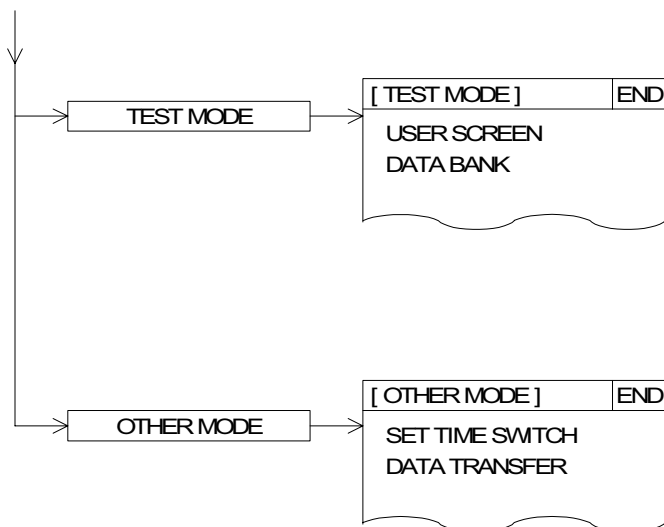

- TEST MODE (Refer to Chapter 11.)
The contents of the user screens can be confirmed. In addition, data files can be edited, and debugging can be performed.

F940GOT, F943GOT and F940WGOT can display the communication.

- OTHER MODE (Refer to Chapter 12.)
Setting of the time switch, printer output, entry code, system, etc. can be performed.

5.4 Security function (screen protection function)

In the user screen mode, screens can be set so that they only open to certain operators who know an entry code. This is so that general operators cannot perform unnecessary operations. This function is called security function (screen protection function).

5.4.1 Outline of security function

To use the security function, the security level should be set for each user screen. Set the level within the range of 0 (lowest) to 15 (highest). When any entry codes have not been registered, all screens can be displayed (In this case, the security level is "0"). An entry code can be set using the screen creation software.

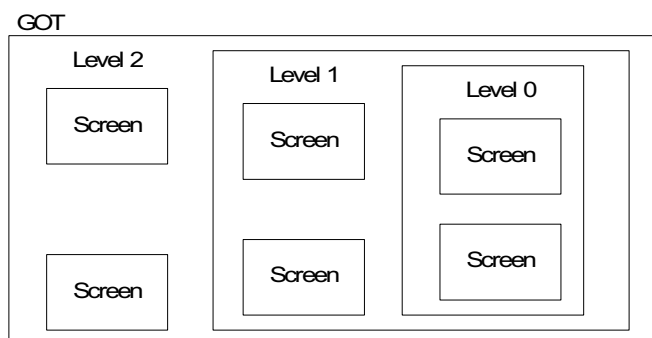

- An entry code can be set using up to 8 numerics. (Only numbers 0 to 9 can be used in the F920GOT.)

By entering a correct entry code, the user can display and manipulate screens whose security level is equivalent to or lower than the entered code

5.4.2 Input of entry code

To enter code, the entry code input screen should be displayed.

According to the versions of the GOT, the following functions are available to display the entry code input screen.

- Keyboard display by a touch key : When a touch key is pressed, the entry code input screen is displayed.
- Automatic keyboard display function: The keyboard is automatically displayed when a screen is changed to a screen with higher security.

GOT version

Product model name	Keyboard display by touch key	Automatic keyboard display
F930GOT, F933GOT	V1.00	V4.00
F930GOT-K	From first product	
F940GOT, F943GOT	V1.00	V6.00
F940WGOT	V1.00	V1.00

- On the F920GOT-K, entry code input window is displayed automatically.

Screen creation software version

Software name	Keyboard display by touch key	Automatic keyboard display
GT Designer	SW1D5C-GOTR-PACKE (C)	SW5D5C-GOTR-PACKE V5.05F
FX-PCS-DU/WIN-E	V2.00	-

Entry code input keyboard displayed by a touch key

In order to display the entry code input keyboard by a touch key, set the key code "FF68" to the touch key arranged on the screen.

Screen example

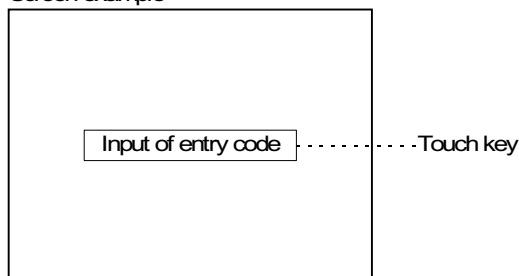

- To set this touch key, enter "FF68" to the key code.
- When the touch key is pressed, the entry code input screen is displayed.
- When a screen whose security level is higher is tried to be displayed, an alarm sound is issued three times. Set a touch key, and enter an entry code. Once an entry code is input, the entry code input screen is no longer displayed.
- When an entry code has been registered to the screen to be displayed at first in USER SCREEN MODE (screen No. 0 when screens have been created using FX-PCS-DU/WIN-E or screen No. 1 when screens have been created using SW□D5C-GOTR-PACKE), the entry code input screen is displayed even if a touch key to enter an entry code is not provided so that an entry code can be entered.

Automatic entry code input keyboard display function (GT Designer)

If the following is set, entry code input keyboard is automatically displayed when a screen is changed over to a screen with higher security. (The setting shown below is not required in the F920GOT-K.)

- System Information (For details, refer to Section 6.6.)
The b8 in read device (DO) is ON:
Automatic keyboard display is valid. ○ is the head number of specified read device.

Example: when read device (DO) is assigned to D10

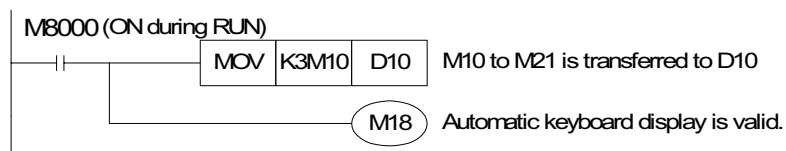

Screen example

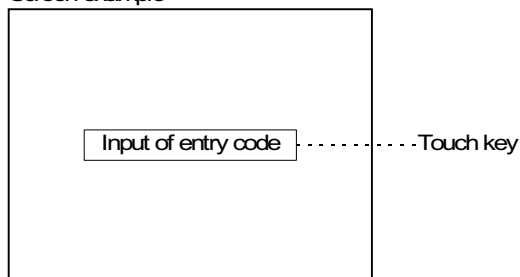

- To set this touch key, enter "FF68" to the key code.
- When the touch key is pressed, the entry code input screen is displayed.

5.4.3 Reset of entry code

To reset an entry code and return to the initial setting (in which security is valid), a touch key should be provided on the screen.

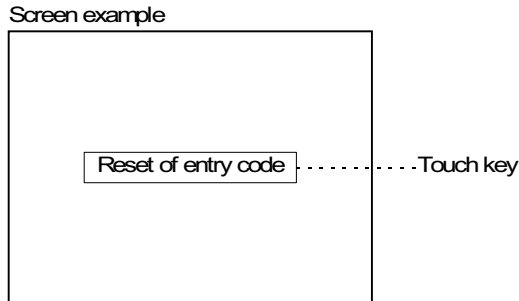

- To set this touch key, enter "FF69" to the key code.
- The entry code is reset also when the power of the GOT is turned off. When the power is turned on at the next time, the security is valid.
- In order to reset the entry code in the F920GOT-K, press the ESC key and then 9 when the screen is not waiting for numerical key-in (when the cursor is not displayed).

Use example

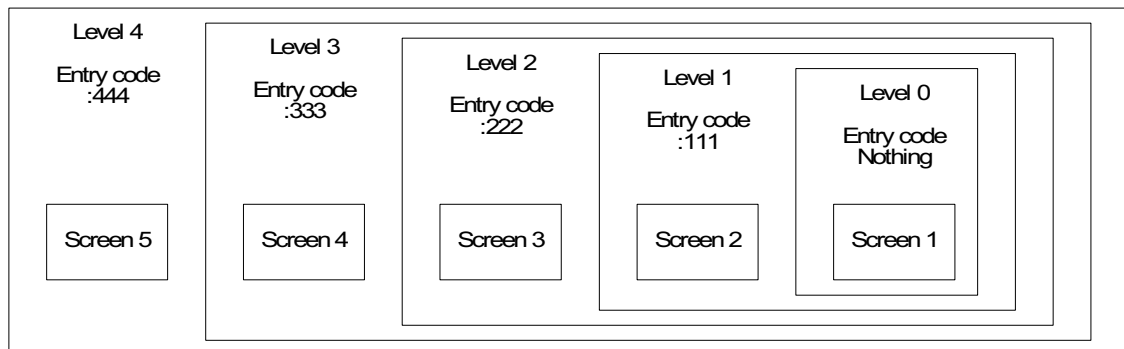

- Suppose that the security level is set in the screen creation software for Screens 1 to 5 shown above.
- In this case, Screen 1 is displayed when the power is turned on (Level 0).
- When an entry code "222" is entered, Screens 1 to 3 can be displayed and manipulated.
- When an entry code "444" is entered while Screens 1 to 3 are displayed, Screens 1 to 5 can be displayed and manipulated.
- When the entry code is reset while Screens 1 to 5 are displayed, Screen 1 is displayed (initial status).
- * In the use example shown above, the levels and the screen numbers are consecutive for easy understanding. The levels and the screen numbers are not necessarily consecutive.

Example: Screen 1 : Level 3
 Screen 2 : Level 7
 Screen 3 : Level 5
 Screen 10 : Level 2

5.4.4 Upgrading of security function

The following functions have been added to the security function, making the system easier to use.

Applicable version

GOT

Product model name	Version
F930GOT, F933GOT	V4.00
F920GOT-K, F930GOT-K	From first product
F940GOT, F943GOT	V6.00
F940WGOT	V1.00

Screen creation software

Software name	Applicable version
GT Designer	SW1D5C-GOTR-PACKE V5.05F
FX-PCS-DU/WIN-E	V2.00

1) Function to display error messages at entry code input

Previously no error message was displayed at the time of incorrect entry code input or switching to protected screens.

Now it is possible to produce an error display by setting it as shown below.

- Setting for GT-Designer (SW5D5C-GOTR-PACKE)

a) The following window can be displayed by using "Common" → "Password".

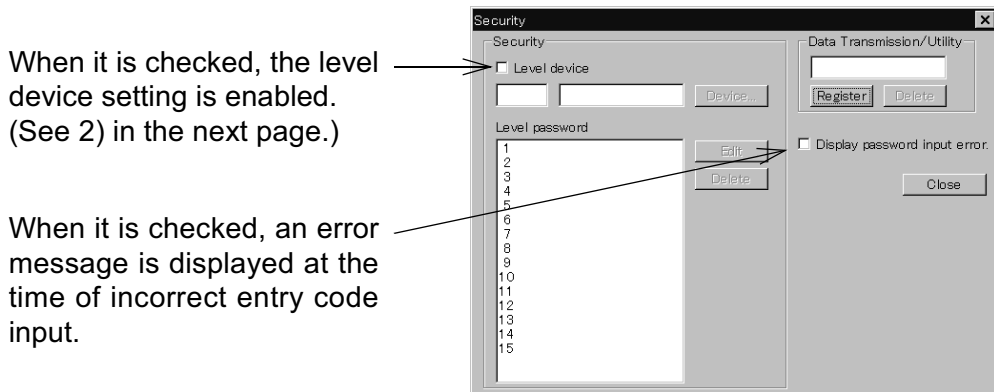

- Entry code input and contents of error message

Error message	
Password is incorrect.	When the entered entry code is incorrect (Enter the correct entry code.)
This operation is not permitted.	When switching to a high-security-level screen is attempted (It is necessary to enter the entry code.)

- Only numbers 0 to 9 can be used for an entry code in the F920GOT-K.

2) Level device setting function

By setting as shown below, the current security level (0 to 15) set on the GOT can be checked through the PLC.

- Setting for GT-Designer (SW5D5C-GOTR-PACKE)

a) The window shown in the previous page can be displayed by using "Common" → "Password".

b) When the "Level device" item is checked, device setting for security level can be made. By checking the current set value of the device here, you know the current security level.

3) Security level setting function for system screen

Previously the security level of the system screens (No.1000 to 1030) was fixed at 15. Now it is possible to set the security level of the system screens by setting as shown below.

- Setting for GT-Designer (SW5D5C-GOTR-PACKE)

a) The window shown below can be displayed by using "Common" → "Auxiliary setting" → "Screen".

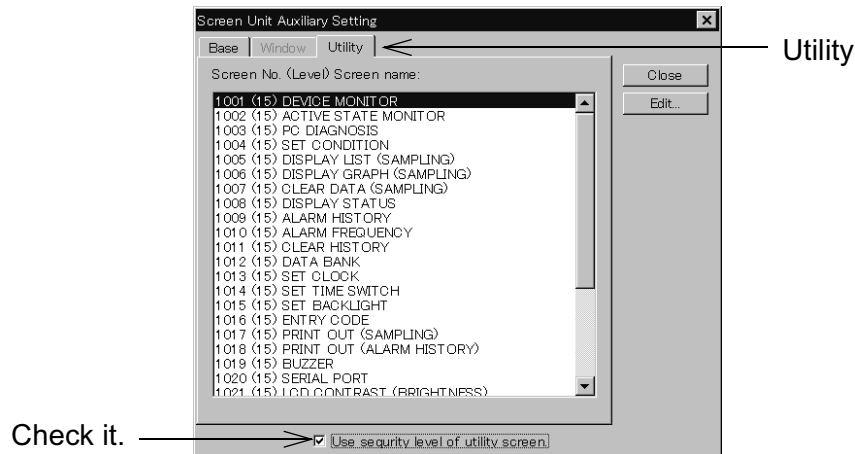

b) When "Use security level of utility screen" at the bottom of the window is checked, it becomes possible to set the "Utility" tag.

c) When "Utility" is selected, the list of the system screens are displayed. Select the number of the screen whose security level you want to change and set the security level by mouse double-clicking or using the "Edit" button.

* If this setting is not performed or the screen data are all cleared, the security level of the system screens is initialized to 15.

6. Creation of Display Screens

Display screens for the GOT can be created using FX-PCS-DU/WIN-E or GT Designer shown below.

- FX-PCS-DU/WIN-E
(compatible with Windows95, V2.20 or later compatible with Windows98 and Windows NT^(R)4.0, V2.50 or later compatible with Windows 2000, V2.60 or later compatible with Windows Millennium Edition)
F920GOT-K, F930GOT-K ... V2.70 or later
F930GOT, F933GOT ... V2.20 or later
F940GOT, F943GOT ... V2.00 or later
F940WGOT ... V2.50 or later
- GT Designer
(compatible with Windows95, Windows98, Windows NT^(R)4.0)
F920GOT-K, F930GOT-K ... SW5D5C-GOTR-PACKE V5.26C or later
F930GOT, F933GOT ... SW1D5C-GOTR-PACKE(H) or later
F930GOT-K ... SW5D5C-GOTR-PACKE V5.26C or later
F940GOT, F943GOT ... SW1D5C-GOTR-PACKE(A) or later
F940WGOT ... SW5D5C-GOTR-PACKE(F) V5.05F or later



a) Data can be read from and written to the GOT using FX-PCS-DU/WIN-E.

b) Data can be read from and written to the GOT using GT Designer.

This chapter describes the compatibility of data when these screen creation software are used. For the operating procedures of the software, refer to the software operation manuals offered separately.

6.1 Outline of compatibility of screen data

Display screens for the GOT can be created using either FX-PCS-DU/WIN-E or GT Designer, but note the undermentioned matters.

- Functions dedicated to the FX-PCS-DU/WIN-E (Refer to Section 6.1.1.)
Functions of the GOT enabled only by FX-PCS-DU/WIN-E.
These functions cannot be read or written using GT Designer.
- Common functions (Refer to Section 6.1.2.)
Functions enabled by both FX-PCS-DU/WIN-E and GT Designer.
However, some function names are different and some functions are restricted in each software.
- Functions dedicated to GT Designer (Refer to Section 6.1.3.)
Functions enabled only by GT Designer. They are not enabled by the GOT-F900 series nor FX-PCS-DU/WIN-E.

6.1.1 Functions dedicated to screen creation software FX-PCS-DU/WIN-E

The functions shown below are effective only when FX-PCS-DU/WIN-E is used. These functions are not available when GT Designer is used.

1) Screen display

- Indicator : A specified area on the screen can be inverted (or colors are replaced).
- Buzzer : When a specified bit device in the PLC becomes ON, the buzzer of the GOT sounds.
- Data file transfer : When a specified touch key is pressed, the current value of the 16-bit data register in the GOT is transferred to the data register (D) in the PLC.
- External character: Figures and symbols of 16×16 bits created by the user can be used.
- Data change : The ten-key keypad can be displayed by pressing a touch key.
- Indicator (screen) : When a bit device in the PLC becomes ON, a specified screen is overlaid on the current screen.

2) Device comment

This device monitor function in HPP mode is used to display comments instead of devices. (The comment display is available only in the F940GOT, F943GOT, and F940WGOT.)

■ Important point

Note: When the functions (1) to (3) above are used, they are treated as follows in GT Designer.

- Read data to GT Designer
Screen data excluding functions (1) to (3) above is read.
When the data is read, screen data in the GOT main body is not changed.
- Write data to GOT
Functions (1) to (3) above cannot be set.
When data is written from GT Designer to GOT including functions (1) to (3) above, functions (1) to (3) in the GOT are deleted. Accordingly, functions (1) to (3) should be set again using FX-PCS-DU/WIN-E.

6.1.2 Common functions

The functions shown below are available in both FX-PCS-DU/WIN-E and GT Designer. The table below shows the difference in names in accordance with the setting contents of the items (attributes).

When the functions shown below are read or written using the other software, their names are automatically converted.

In this manual, different function names are used in accordance with the screen creation software from Chapter 19.

Display function

Name in GT Designer	Difference in set item (attribute)	Name in FX-PCS-DU/WIN-E
Numerical Display	←When setting is forbidden	Number
Numerical Input	←When setting is permitted	
Ascii Display	←When setting is forbidden	Ascii
Ascii Input	←When setting is permitted	
Comment	In case of word device→	Library Text
	In case of bit device→	Text Indicator
Part Display	In case of word device→	Library Image
	In case of bit device→	Image Indicator
Lamp	Name is different.	Label Indicator
Panelmeter	Shape displayed on screen is different.	Panel Meter Circle Graph
Clock	Name is different.	Date
	Name is different.	Time
Trend graph	Sampling is available in background processing.	Trend Graph
Line graph	Name is different.	Line Graph
Statistics	In case of bar graph→	Proportional Bar Graph
	In case of circle graph→	Proportional Pie Graph
Bar	Reference value is equivalent to upper or lower limit value. Only one data can be set at a time.→	Bar Graph
Line (Draw Figure)	Same→	Line
Rectangle	Name is different.	Box
Circle	Ellipse is not available.→	Circle
Bitmap	←Saved in objects file.	Image
Text	Name is different.	Text

- *1 In the F920GOT-K, clock data of the PLC is displayed.
This function can be used only when connected to the PLC equipped with a clock function or either a memory cassette or memory board.

Key operations

Name in GT Designer	Difference in set item (attribute)	Name in FX-PCS-DU/WIN-E
Bit operation (bit momentary)	Names are different.	Switch (momentary)
(bit ALT)		Switch (alternate)
(bit SET)		Switch (set)
(bit RST)		Switch (reset)
Base changeover	←Bit condition, etc. cannot be converted.	Change Screen
Word operation (Indirect + Fixed value)	Names are different.	Increment
(Indirect + Fixed value)		Decrement
(Fixed value)		Write Constant

Others

Name in GT Designer	Difference in set item (attribute)	Name in FX-PCS-DU/WIN-E
Parts	Only bitmap is converted. →	Image library
Comment	Name is different.	Text library
System information	←Role of each device is different.	Control device
Password	Name is different.	Entry code

- The table below shows settings specific to GT Designer. These settings are available in F900GOT, but they are different. (These settings are not enabled by FX-PCS-DU/WIN-E, either.)

Display frame	The display frame can be selected among only images built in the system software. (In the A900GOT Series, arbitrary images can be selected.)
Arithmetic operation	The arithmetic operation function is not enabled except some of the objects. In Numerical Display and Numerical Input, arithmetic operation can be performed only while the gain and offset are specified (that is, while the arithmetic operation formula is fixed).
Display trigger	Only "Always" is available as the display trigger except some of the objects. In line graphs, the display trigger is used to specify the sampling cycle.
Range specification	The color and the blink attribute cannot be changed over by a value of a word device. Only the range in the normal status can be specified.
Security	The security in the unit of screen is available, but the security in the unit of object is not available. The available number of security levels is 15 in the same way as the A900GOT.
Multi-device monitor	In objects (such as Trend Graph) monitoring two or more devices, only consecutive devices can be assigned. Random assignment is not available.

6.1.3 Functions dedicated to GT Designer

The functions shown below are dedicated to GOT-A900. They are not available in the F900GOT. (For details of these functions, refer to the operation manual of GT Designer.)

1) Screen display

- Line Freeform : Displays a line indicating a zigzag or polygon in one stroke.
In the F900GOT, two or more lines can be used to display such a figure.
- Polygon : Displays a polygon.
In the F900GOT, two or more lines can be used to display a polygon.
- Sector : Displays a sector.
- Arc : Displays an eclipse.
- Scale : Displays the scale for bar graphs and panel meters
In the F900GOT, the scale function is given to bar graphs and meters.
- Paint : Paints (fills) a specified area (which may be a polygon).
In the F900GOT, boxes and circles can be filled.
- Data List : Displays the data list in the form of a table.
- Level : Displays the level within a specified image range.
In the F900GOT, the level can be expressed in the form of bar graph (box).
- Part Movement : Moves displayed parts on a specified trace.

2) Printer output

- Report : Outputs the data to the printer in accordance with a specified format.

3) Noise output

- Noises can be output.
In the F900GOT, buzzer sounds can be issued.

4) Window screen

- A window can overlay the display screen.

5) Station number changeover

- When two or more A900GOT units access the PLC, the A900GOT unit number which is to access the PLC can be specified.
In the case of F900GOT, up to four units can access an FX Series PLC without specifying the station number.

6.2 Transfer of screen data

Pay rigid attention to the cautions below when screen data created in FX-PCS-DU/WIN-E is read/written using GT Designer or when screen data created in GT Designer is read/written using FX-PCS-DU/WIN-E.

If unavailable settings are contained in the screen data, an alarm message is displayed when the screen data is read. In such a case, check the contents of the screen data.



1) Screen data

- Read/write of the functions dedicated to FX-PCS-DU/WIN-E (Refer to Section 6.1.1.)

a) FX-PCS-DU/WIN-E:

No problems are expected in both read and write.

b) GT Designer:

If the GOT has dedicated functions, such functions are not read.

- Setting of display screen changeover (Refer to Section 6.1.2.)

a) FX-PCS-DU/WIN-E:

Names and contents of the functions are automatically converted into those used in the software.

b) GT Designer:

Names and contents of the functions are automatically converted into those used in the software.

- Functions dedicated to GT Designer (Refer to Section 6.1.3.)

a) FX-PCS-DU/WIN-E:

These functions cannot be set in the GOT. (That is, these functions cannot be read nor written.)

b) GT Designer:

These functions cannot be set in the GOT. (That is, these functions cannot be read or written.)

2) Setting of display screen changeover

- Screen number (Refer to Section 6.4.2.)
 - a) FX-PCS-DU/WIN-E:
Screen numbers are automatically converted into No. 0 to No. 499, then transferred (in both read and write).
 - b) GT Designer:
Screen numbers are automatically converted into No. 1 to No. 500, then transferred (in both read and write).
- * When the No. of a screen to be displayed is specified from the PLC, a converted screen No. is transferred to the GOT. Accordingly, the used sequence program is required to be changed.
- Handling of common setting screen
The contents set on the common setting screen in FX-PCS-DU/WIN-E are treated as screen number 501 in GT Designer.
However, screen No. 501 is treated as a user screen, so the contents of screen number 501 are not shared by all screens in the same way as FX-PCS-DU/WIN-E. The screen overlay function (overlap window 1 or 2) or the screen call function should be used so that the contents of screen number 501 are shared by all screens.
- Background color of screen
When screen data created using FX-PCS-DU/WIN-E is transferred to GOT and then read using GT Designer of SW3D5C-GOTR-PACKE(B) or before, the background colors are all converted to "Black".
If you want to change the background color, do so using "Screen" in "Auxiliary Setting".
When such data is read using GT Designer of SW3D5C-GOTR-PACKE(C) or later, the background colors are read as they are.

6.3 Appropriation of screen data

Screen data made for one type of GOT can be converted in the screen creation software, for use in a different type of GOT.

Care must be taken with the screen layout and unit functionality, as these may be different between various GOT models. (Refer to 6.3.1 and 22.3.)

6.3.1 Conversion from FX-50DU-TK(S)-E to F940GOT

By using the screen creation software FX-PCS-DU/WIN-E, screen data in an FX-50DU-TK(S)-E can be converted and used for the F940GOT.

The compatibility of the data in such a case is described below.

- How to use the screen data
When the model is changed from FX-50DU to F940GOT using FX-PCS-DU/WIN-E (V2.00 or later), screen data is converted so that it can be used in the F940GOT.
- Cautions on conversion
Pay close attention to the following cautions during conversion.
 - 1) Alarm function
The alarm notification method, "Overlap", "Change Screen" or "Print" can be selected for each alarm in the 50DU. In the F940GOT, only one alarm notification method can be selected for all alarms (That is, one alarm notification method is used for every alarm.).
When data in the 50DU is converted and used in the F940GOT, the alarm notification method selected in the head alarm device in the 50DU is adopted for every alarm.
 - 2) Display of user screens
 - a) Image, Library Image and Image Indicator
When a black-and-white image is selected to be used with the functions above, it can be displayed in colors other than black and white in the 50DU by specifying the colors.
In the F940GOT, the same operation can be performed using the "Indicator" function.
 - b) Number and Ascii
Only numerics and character codes can be changed on the display screen.
Data can be changed while "Permit" is selected in "Number" and "Ascii". When a numeric or character code on the screen is touched, a keyboard for data change is displayed. (Each numeric and character code displayed on the screen, functions as a touch key.)
 - c) Keyboard
The display position of the keyboard for numerics and text can be moved on the screen in the F940GOT.
 - 3) Screen changeover function
In the F940GOT, if the key condition and input condition are set to "Always" when a screen is changed over from the PLC, priority is always given to screen changeover by a control device in the PLC.
Accordingly, if both the key condition and input condition are set to "Always" in the setting of screen changeover in the 50DU, the setting of screen changeover or the used sequence program should be changed. (Refer to Chapters 20 and 22.)

6.4 Concept on screen display

- To display a screen
 - Each screen should be created using characters and graphics.
When FX-PCS-DU/WIN-E is used: Refer to Chapter 19.
When GT Designer is used: Refer to Chapter 21.
- To change over screens
 - Screen changeover should be set.
When FX-PCS-DU/WIN-E is used: Refer to Chapter 20.
When GT Designer is used: Refer to Chapter 22.

6.4.1 Screen display position

The display position of each screen construction element can be specified in dots. Touch keys should be positioned according to the following mesh.

The meshes and matrix configuration of each GOT is as follows.
(One mesh consists of 16 × 20 dots.)

F930GOT, F933GOT, F930GOT-K : 15 (horizontal) × 4 (vertical)
F940GOT, F943GOT : 20 (horizontal) × 12 (vertical)
F940WGOT : 30 (horizontal) × 12 (vertical)

Last column composed of 14 dots

6.4.2 Number of display screens and screen numbers

- Up to 500 screens can be displayed.
- A screen number is assigned to each display screen.
When FX-PCS-DU/WIN-E is used: No. 0 to No. 499
When GT Designer is used: No. 1 to No. 500
 - * Although the first screen number is different, it is automatically converted while it is read in accordance with the used software.

6.4.3 Number of display elements and data capacity

Each display element is managed as screen data. The allowable number of screens is restricted as shown below.

Item		Description
Total screen data size	F920GOT-K	128KB (user screens etc)
	F930GOT F933GOT F930GOT-K	256KB (user screens etc)
	F940GOT F943GOT	512KB (user screens etc)
	F940WGOT	1MB (user screens etc)
Allowable number of screens	User screens: Up to 500 screens FX-PCS-DU/WIN-E: No. 0 to No. 499 GT Designer: No. 1 to No. 500 System screens: 12 screens in the F920GOT-K. 25 screens in the F930GOT-K, F930GOT and F933GOT. 30 screens in the F940GOT, F943GOT and F940WGOT. Screen No. 1001 to No. 1030.	

6.4.4 Attribute of display element

The display elements are equipped with detailed set items as attributes. Representative attributes are explained below.

Display position:

The X and Y coordinates of the display position are specified. As a mouse is used for the screen creation software, the coordinates specified by the mouse are registered.

Character size:

1 character: 16×8 dots (V \times H)



In the case of the following versions or later, numbers can be entered and displayed in high-definition fonts ($\times 4$ or more) and small character fonts (6×8 dots). (For further details, refer to the next page.)

Applicable version

GOT

Product model name	Version
F920GOT-K	From first product
F930GOT-K	From first product
F930GOT, F933GOT	V4.10
F940, F943GOT	V6.10
F940WGOT	V1.10

Screen creation software

Software	
GT Designer	SW5D5C-GOTR-PACKE V5.05F
FX-PCS-DU/WIN-E	V2.50

- High-definition font

High-definition font display is available only when the following objects and sizes are selected and setting for high-definition font is made using the screen creation software.

- Applicable condition

Applicable objects

Numerical Display, Numerical Input

High-definition font can not be specified for objects other than the above.

Valid size

		Lateral magnification				
		1	2	4	6	8
Longitudinal magnification	0.5					
	1					
	2			●	●	●
	3			●	●	●
	4			●	●	●

Note: Only the magnifications indicated by "●" are valid.

Valid characters

17 characters of 0 to 9, A to F and a decimal point

- "6 × 8 dots" font

"6 × 8 dots" font display is available only when the following objects and sizes are selected and setting for "6 × 8 dots" font is made using the screen creation software.

- Applicable condition

Applicable objects

Comment, Lamp, Clock, Alarm List, Alarm History, ASCII Display, ASCII Input, Numerical Display, Numerical Input, Touch key

"6 × 8 dots" font cannot be specified for object other than the above.

Valid size

		Lateral magnification				
		1	2	4	6	8
Longitudinal magnification	0.5	●				
	1					
	2					
	3					
	4					

Note: Only the magnifications indicated by "●" are valid.

Valid characters

ASCII characters of character codes 20H to 7FH (96 characters)

Color specification:

F940WGOT-TWD-E

: 256 colors

F940GOT-SWD-E, F943GOT-SWD-E

: 8 colors (white, black, red, blue, yellow, green, purple and light blue)

F920GOT-BBD5-K-E, F930GOT-BBD-K-E, F930GOT-BWD-E,
F933GOT-BWD-E, F940GOT-LWD-E, F943GOT-LWD-E: 2 colors (black and white)

- In the case of FX-PCS-DU/WIN-E, display color, background color, needle color and frame color are available.
- In the case of GT Designer, character color, plate color and frame color are available.

Screen background color:

In the case of both FX-PCS-DU/WIN-E and GT Designer, colors can be specified according to the display unit.

F920GOT-BBD5-K-E, F930GOT-BBD-K-E, F930GOT, F930GOT, F933GOT:
2 colors (black and white)

F940GOT, F943GOT : 8 colors (Select white or black when F940GOT-LWD-E or F943GOT-LWD were used.)

F940WGOT : 256 colors

PLC Device specification:

Specification of devices in PLC (The following apply to the PLCs manufactured by Mitsubishi Electric.)

- Word device: Timer (T), counter (C), data register (D) and index register (V and Z). In case of the A Series, link register (W) and file register (R) can be also specified.
- Bit device: Input (X), output (Y), auxiliary relay (M), state (S), timer (T) and counter (C). In A Series, F and B can be also specified.

Upper/lower limit:

The upper limit and lower limit of word devices to be displayed are set.

Word devices are displayed within the range determined by the upper and lower limits.

6.5 Screen call function and overlay function

In the GOT, user screens can be overlaid.

The screen call function which specifies screens to be overlaid using the screen creation software and the overlay function which specifies screens to be overlaid from the PLC are available.

1) Screen call function (For details, refer to Section 6.5.2.)

Screens to be overlaid can be specified preliminarily using the screen creation software. A base screen and up to five other screens can be overlaid at a time.

2) Overlay function (For details, refer to Section 6.5.3.)

When screens to be overlaid are specified from the PLC (Refer to Chapters 9 and 11), a base screen and up to two other screens can be overlaid at a time.

When this overlay function is used together with the screen call function, screen call is effective only for the base screen. The screen call function is not effective for the second and third screens to be overlaid.

(If the screen call function is used for the second or third screens, the base screen selected in the screen call function is overlaid.)

- In both screen call and overlay function, when other functions such as touch keys and numeric change are displayed, such functions are effective on all of the overlaid screens. If functions are displayed in the same position, the function on the top screen is effective.



The base screen is located at the bottom. If touch keys are displayed in a same position, the touch key on the overlaying screen 2 located at the top is effective.

6.5.1 The writing function of the initial display screen number (GT Designer is used.)

When the GOT is turned ON, user screen No. 1 will be displayed.

To display this screen, the GOT writes '1' in the data register assigned in GT Designer for PLC screen changeover (base screen) at power ON.

The user can set a different screen to be displayed at power ON, in this location.

Applicable version

GOT

Product type name	Version
F920GOT-K	From fist product
F930GOT-K	From fist product
F930GOT, F933GOT	V4.00
F940GOT, F943GOT	V5.00
F940WGOT	V1.00

Screen creation software

Product type name	Version
GT Designer	SW5D5C-GOTR-PACKE or later
FX-PCS-DU/WIN-E	Not available.

- Set method

- 1) Select "OTHER MODE" - "SET-UP MODE" - "AUXILIARY SETTING".

- 2) Select "WRITE" or "DOES NOT WRITE".

An initial value is "WRITE".

* When using the F920GOT-K, settings can be made when only using GT Designer (system screen settings in the GOT are unavailable).

WRITE : Mode to write "1" in registered for screen change when power supply is turned ON.

DOES NOT WRITE: Mode not to write "1" is registered for screen change when power supply is turned ON.

When a number is set in the data register assigned for screen changeover, the screen No. 1 is displayed and then the screen corresponding to the current value is displayed after that.

6.5.2 Screen call function

When screen call is used, screens are overlaid as shown below in accordance with the screen creation software used.

1) FX-PCS-DU/WIN-E

When this software is used, 500 user screens No. 0 to No. 499 and the common setting screen can be overlaid.

The common setting screen is always overlaid by other screens.

Accordingly, when screen call is used, the common setting screen, base screen and up to four other screens (that is, up to 6 screens in total) can be overlaid.

Display example

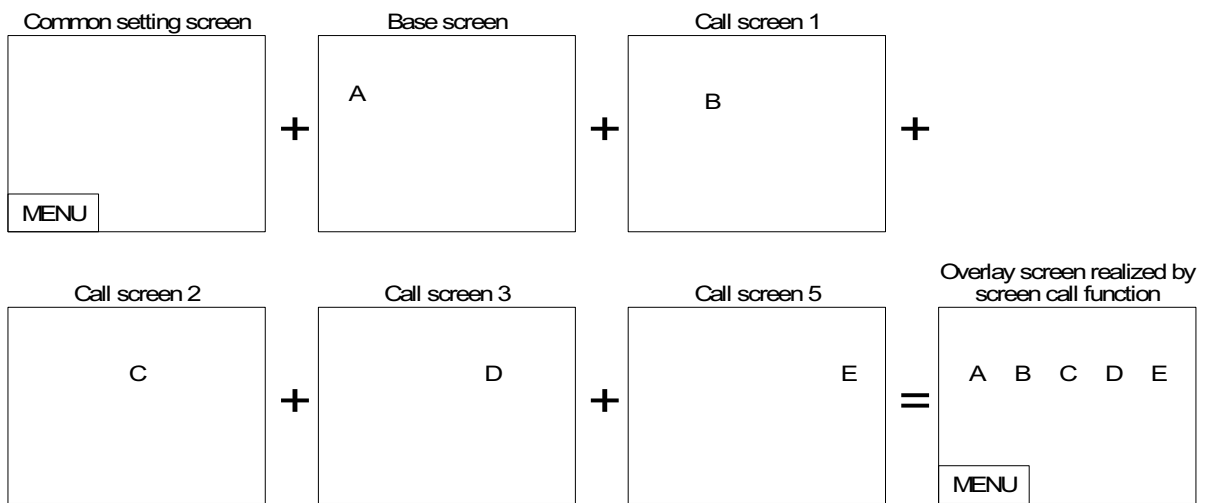

2) GT Designer

When this software is used, 500 user screens No. 1 to No. 500 can be overlaid.

When screen call is used, the base screen and up to five other screens (that is, up to 6 screens in total) can be overlaid.

Display example

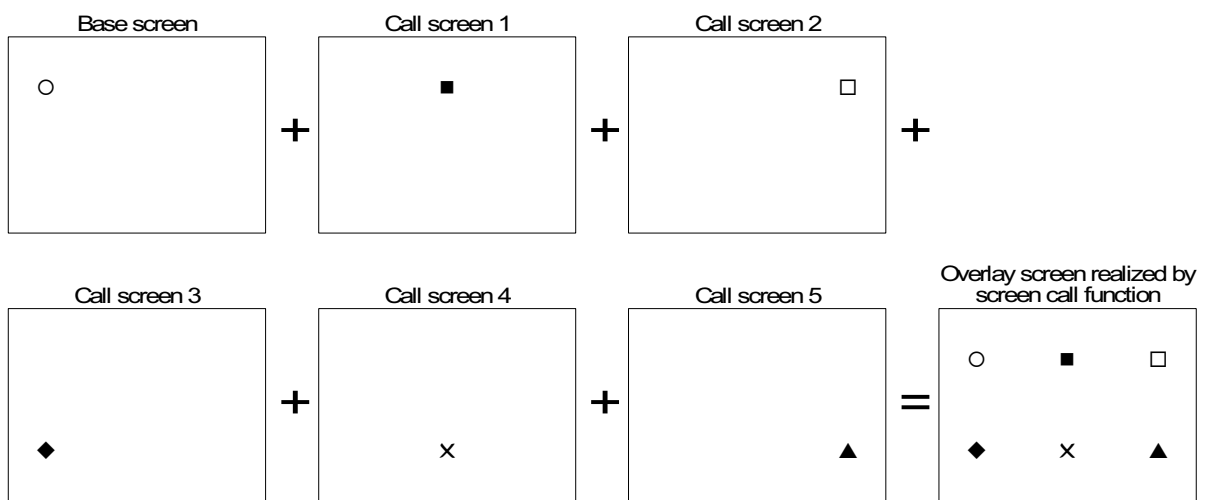

6.5.3 Overlay function

The base screen and up to two other screens (3 screens in total) can be overlaid. Perform the following setting in accordance with the screen creation software used.

1) Setting in FX-PCS-DU/WIN-E

Use control devices to realize screen overlay (Refer to Section 6.6.).

Bit and word devices are available as Interface Devices. Only devices necessary for the overlay function are described here.

Data register (D), timer (T) and counter (C)

The screen numbers to be overlaid can be specified using the contents of word devices set as Interface Devices. The numbers of the screens currently displayed can be monitored in the PLC.

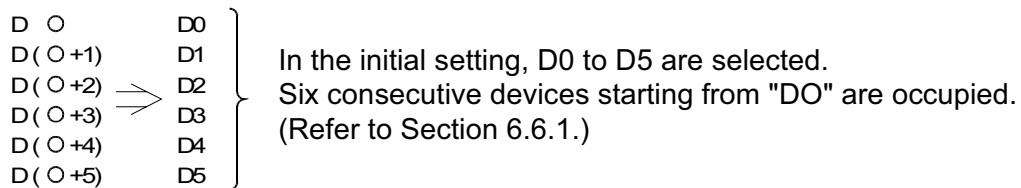

D0 to D2 specify the screen numbers to be displayed. D3 to D5 specifies the screen numbers of screens currently displayed.

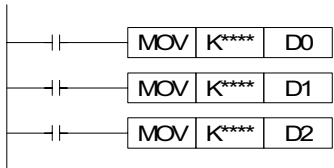
GOT (FX-PCS-DU/WIN-E)	PLC program
D0: Specifies the number of the base screen to be displayed. D1: Specifies the number of the screen to be overlaid secondly. D2: Specifies the number of the screen to be overlaid thirdly.	 <p>When overlay is not performed, enter "-1" to both D1 and D2.</p>
D3: Stores the number of the screen currently displayed. D4: Stores the number of the second screen when two or three screens are overlaid. D5: Stores the number of the third screen when three screens are overlaid.	<p>Monitoring in a peripheral unit</p> User screen numbers (0 to 500) and system screen numbers. (1,000 ~) are stored. When overlay is not performed, "-1" is stored in D4 and D5.

■ Important point

- In FX-PCS-DU/WIN-E, three screens can be overlaid even if the "Overlay Screen" object is used. In this case, however, the overlay function described here is not available.

In screen overlay, the screen specified by a word device is treated as the base screen, and the screens specified by "D0 +1" and "D0 +2" overlay the base screen. When overlaying screens, make sure to set "Destination Screen" of the "Change Screen" object to "PLC data register" and write the screen numbers to be overlaid to word devices (D+0, D+1 and D+2) as shown in the table below. When screen overlay will not be performed, enter "-1" or "FFFF (H)" to the relevant word devices.

D+0	D+1	D+2	
Screen No.	-1	-1	Base screen
Screen No.	Screen No.	-1	Base screen + Overlaying screen 1
Screen No.	-1	Screen No.	Base screen + Overlaying screen 1
Screen No.	Screen No.	Screen No.	Base screen + Overlaying screen 1 + Overlaying screen 2

In the description below, word devices set as initial values are used.
 Word devices: D0, D1 and D2

a) No overlay

- Only the screen specified by the control word device D0 is displayed.

Screen specified by D0
(base screen)

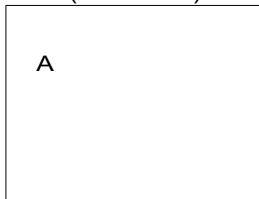

b) Overlay of two screens

- Two screens specified by the control word devices D0 and D1 are overlaid.
- Or two screens specified by the control word devices D0 and D2 can be overlaid.

Screen specified by D0
(base screen)

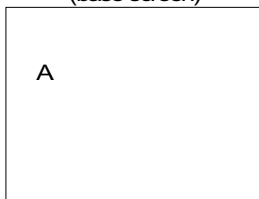

+

Screen specified by D1

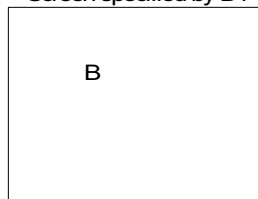

Display screen

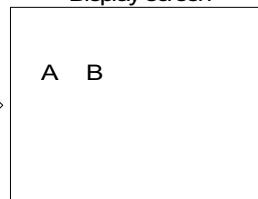

c) Overlay of three screens

- Three screens specified by the control word devices D0, D1 and D2 are overlaid.

Screen specified by D0
(base screen)

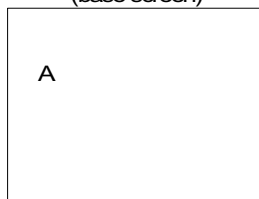

+

Screen specified by D1

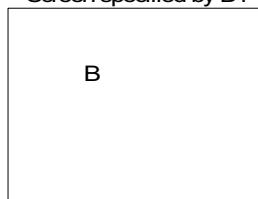

+

Screen specified by D2

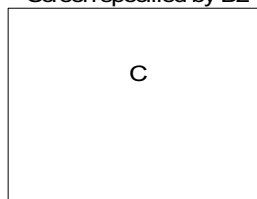

Display screen

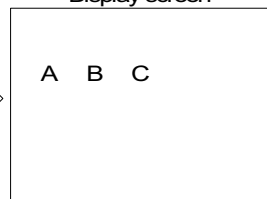

• Example of screen overlay

Screen overlay: Each process is monitored. When a material has run short, the material name is displayed on the screen, and a message is displayed to notify necessity of supplement of the material.

- Line selector switch
Line 1 input: X0
Line 2 input: X1
- Sensor (for bolt count)
Line 1 input: X2
Line 2 input: X3
- Supplement confirmation button: X4

PLC program

Control devices

Word devices to specify screen numbers to be overlaid

D 0 D0
D (0+1) ⇒ D1
D (0+2) D2

Line selector switch

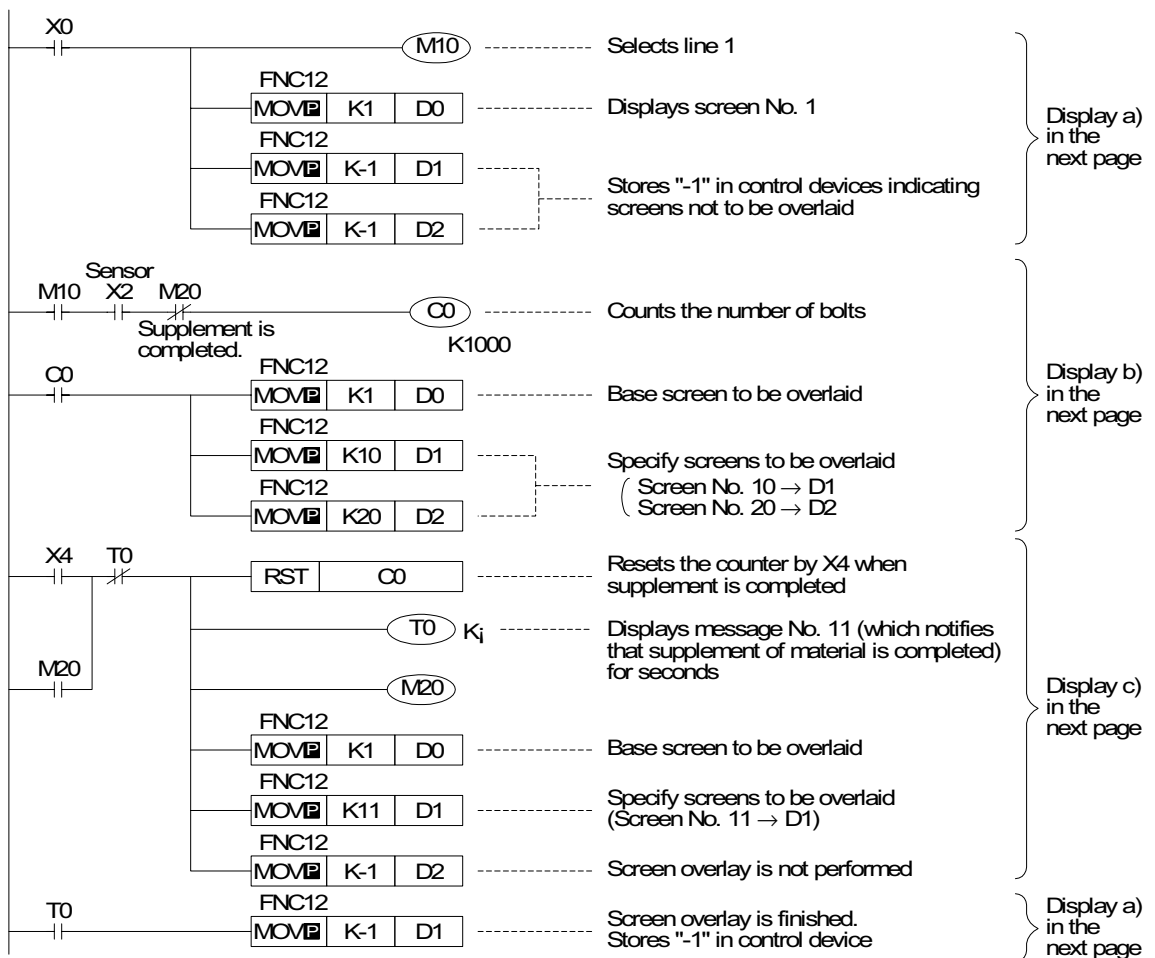

In the program above, line 1 is selected. If line 2 is selected, screens can be overlaid in the same way.

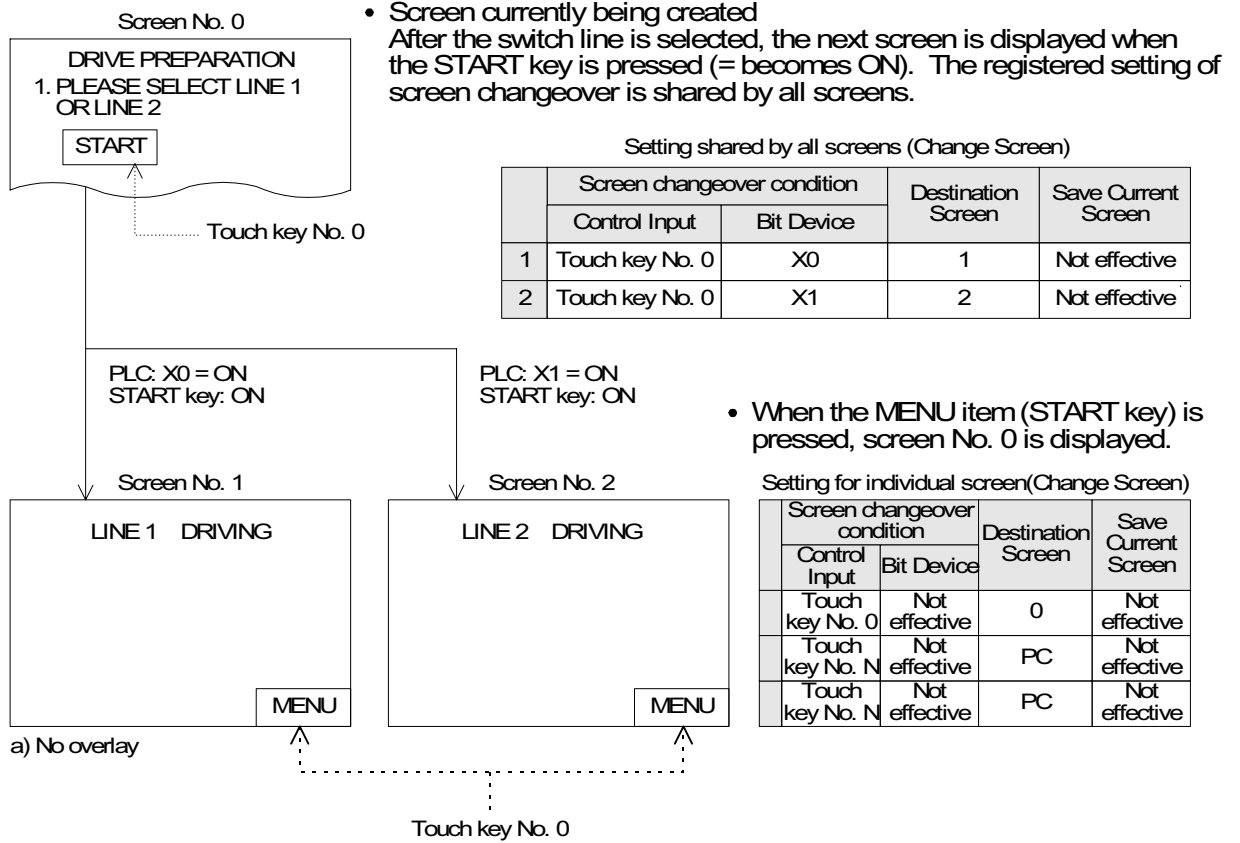

- Overlay of three screens: Screen No. 10 and No. 20 overlay screen No. 1. In this overlay example, line 1 (screen No. 1) is adopted.

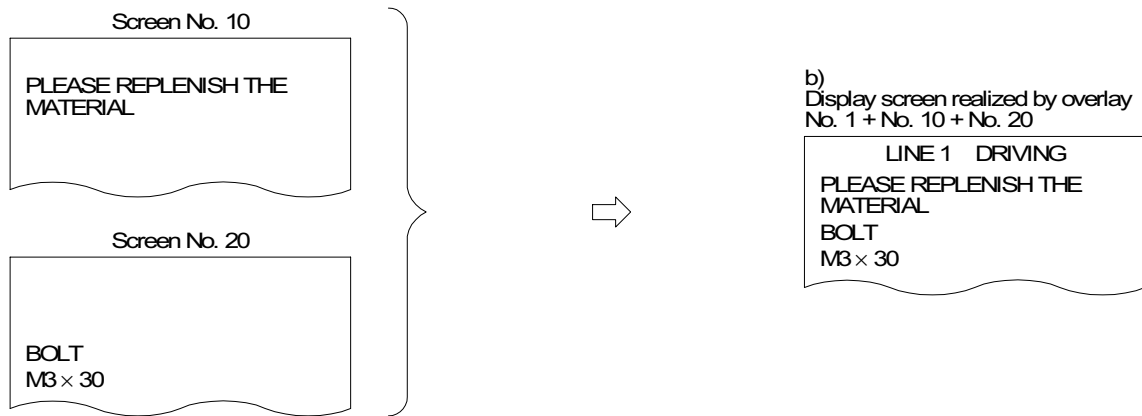

- Overlay of two screens: Screen No. 11 overlays screen No. 1.

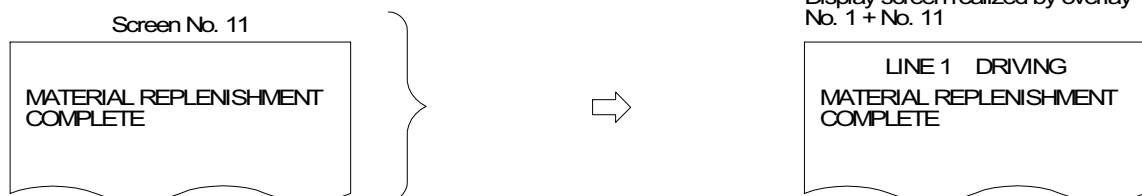

2) Setting in GT Designer

In overlay, use word devices for "Change Screen".

Set the base screen number and the overlaying screen (= overlap window) numbers in accordance with the contents of the word devices set in "Change Screen".

Setting of word devices for screen changeover

Base screen:Word device (The initial value is set to D0.)

Overlap window 1:Word device (The initial value is not set.)

Overlap window 2:Word device (The initial value is not set.)

The base screen, the overlap window 1 and the overlap window 2 can be specified using arbitrary word devices. (The word devices may not be consecutive.)

When overlay is not performed, enter "-1" to the specified devices or perform setting so that overlap windows are not used.

The screen numbers currently displayed can be checked using "Write Device" in "System Information" in the screen creation software. (Refer to Section 8.7.)

Write devices: Head word device

"Head + 1" word device

"Head + 2" word device

The specified screens are overlaid as shown below.

Base screen	Overlap window 1	Overlap window 2	
Screen No.	-1	-1	Base screen
Screen No.	Screen No.	-1	Base screen + Overlap window 1
Screen No.	-1	Screen No.	Base screen + Overlap window 2
Screen No.	Screen No.	Screen No.	Base screen + Overlap window 1 + Overlap window 2

a) No overlay

- Only the base screen is displayed.

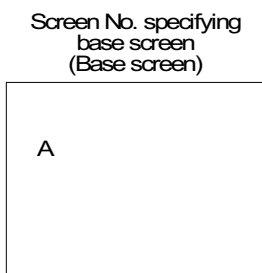

b) Overlay of two screens

- Two screens specified by D0 (base screen) and D1 (overlap window 1) are overlaid.
- Or two screens specified by D0 (base screen) and D2 (overlap window 2) can be overlaid.

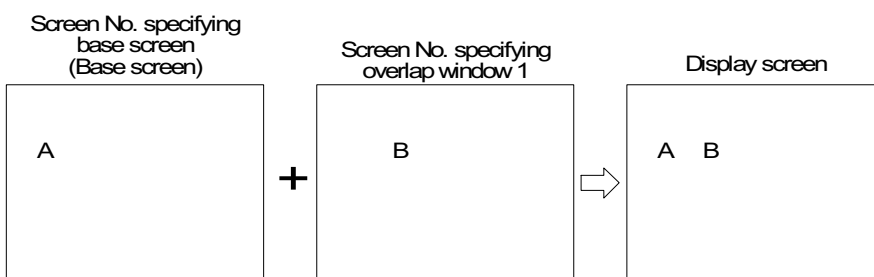

c) Overlay of three screens

- Three screens specified by D0 (base screen), D1 (overlap window 1) and D2 (overlap window 2) are overlaid.

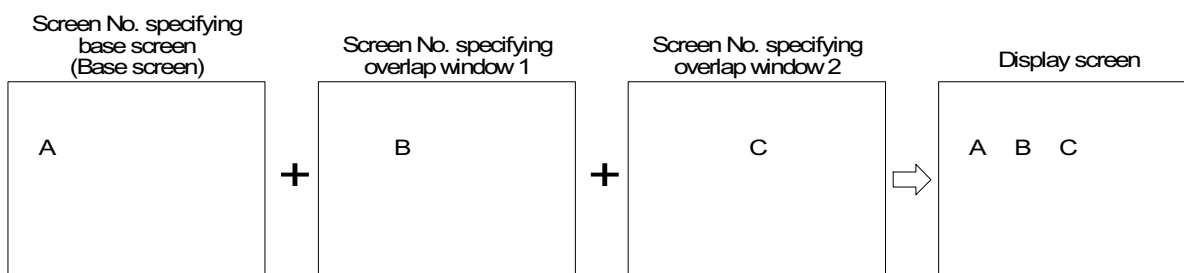

• Example of screen overlay

Screen overlay: Each process is monitored. When a material has run short, the material name is displayed on the screen, and a message is displayed to notify necessity of supplement of the material.

- Line selector switch
Line 1 input: X0
Line 2 input: X1
- Sensor (for bolt count)
Line 1 input: X2
Line 2 input: X3
- Supplement confirmation button: X4

PLC program

Screen changeover

Word devices to specify screen numbers to be overlaid

Base screen D0 }
 Overlap window 1 D1 } Set them in "Switching Screen" in "Common" in GT Designer.
 Overlap window 2 D2 }

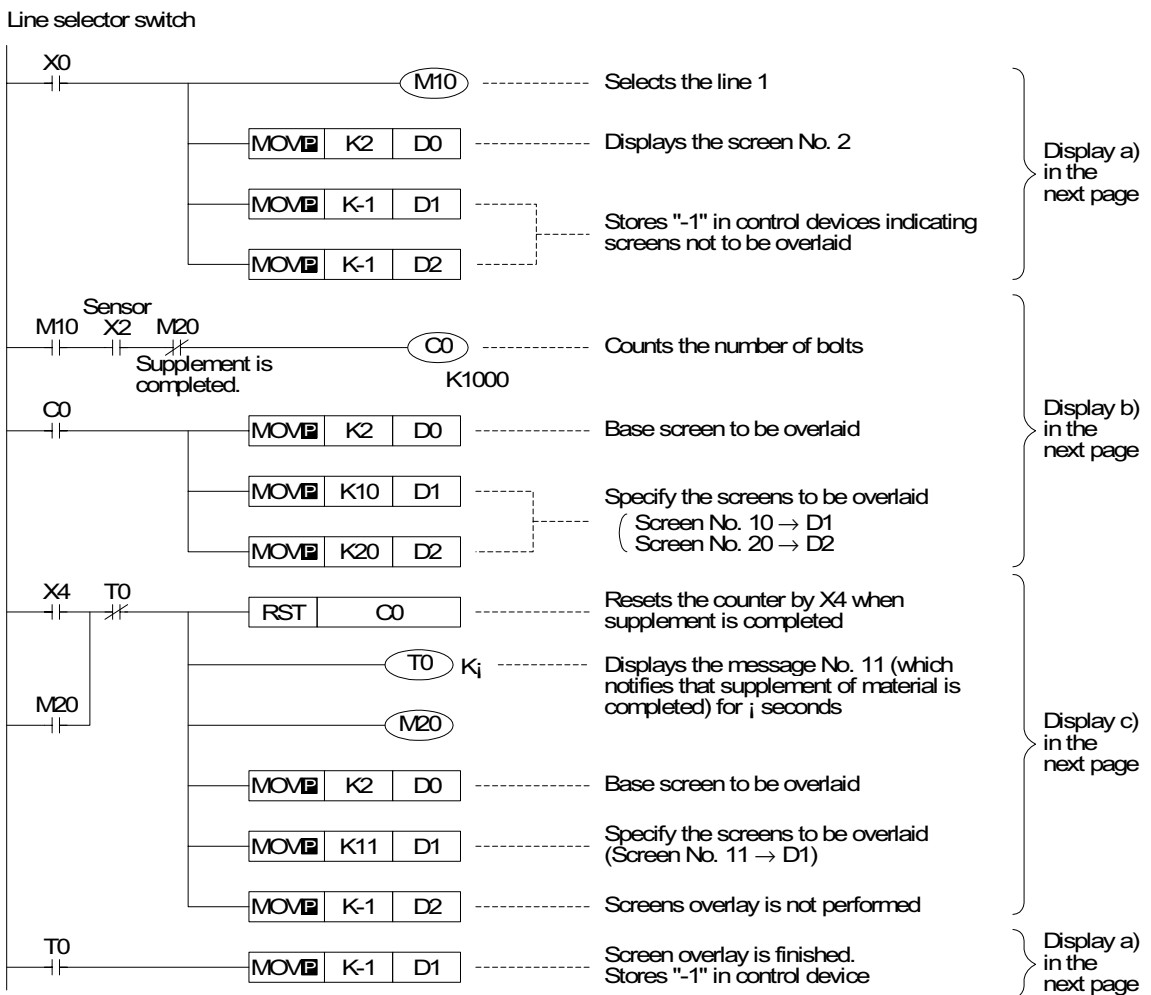

In the program above, the line 1 is selected. If line 2 is selected, screens can be overlaid in the same way.

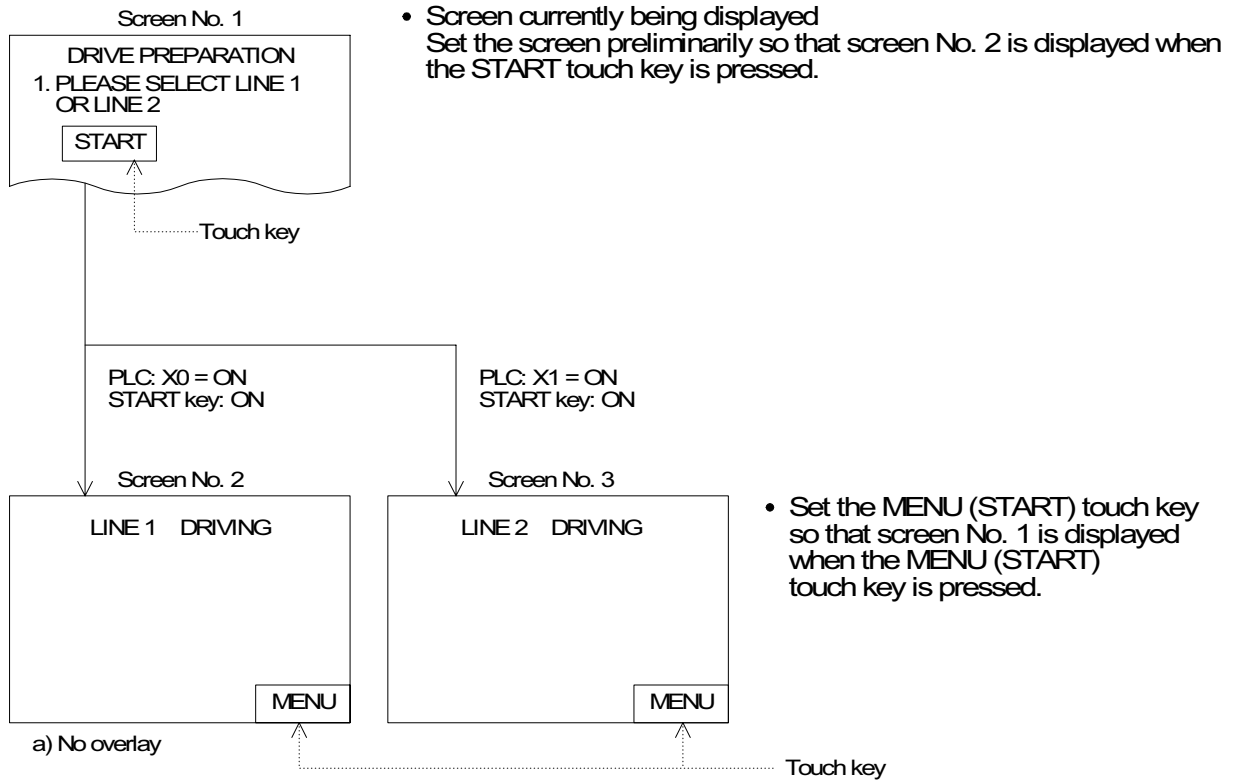

- Overlay of three screens: Screen No. 10 and No. 20 overlay screen No. 2. In this overlay example, line 1 (screen No. 2) is adopted.

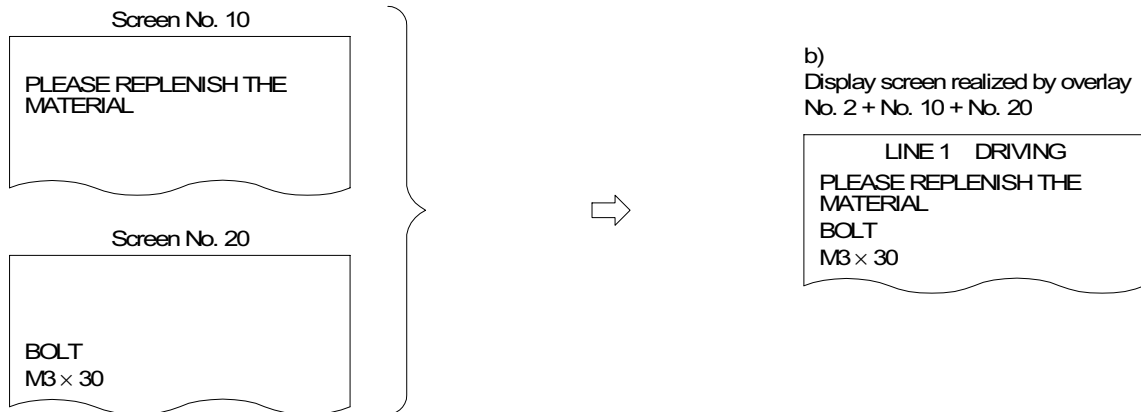

- Overlay of two screens: Screen No. 11 overlays screen No. 2.

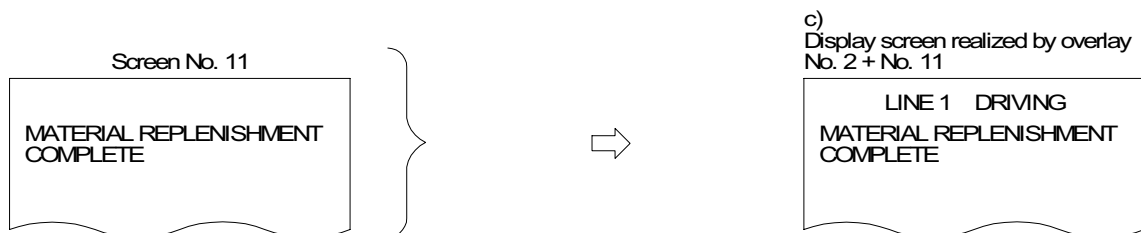

6.6 Interface Devices and system information

Devices are required to be assigned to change over the display screen of the GOT from the PLC or to read the status information including the battery status in the GOT and the alarm occurrence data from the PLC. The term "Interface Devices" is used in FX-PCS-DU/WIN-E. The term "System Information" is used in GT Designer.

6.6.1 Interface Devices (setting in FX-PCS-DU/WIN-E)

- Bit devices: 11 bit devices (X, Y, M, S, T and C) in the PLC are occupied. M0 to M10 are specified when the GOT is shipped from the factory.
- Word devices: Eight word devices (D, T and C) in the PLC are occupied. D0 to D7 are specified when the GOT is shipped from the factory.

Details of bit devices

- Occupied bit devices are used for communication using ON/OFF signals.

[When auxiliary relay M0 is assigned]

	Auxiliary relay	Contents of control
*1	M0	When set to ON from OFF, clears the alarm history.
*2	M1	Remains ON while the device assigned by the alarm function is ON.
*1	M2	When set to ON, extinguishes the backlight of the display screen after the specified time.
	M3	When set to ON from OFF, clears the sampling data acquired in the sampling mode.
*2	M4	Remains ON while sampling is executed in the sampling mode.
	M5	Turns ON as the numeric value setting completion flag.
	M6	Turns ON when the battery of the GOT is deteriorated.
	M7	Remains ON while the grip switch is pressed and held in the handy GOT (excluding the robot handy GOT).
*1	M8	Turns ON when the data read from the bar code reader is stored in the PLC. Turns OFF when the control device M10 is set to ON.
	M9	When set to ON, nullifies bar code inputs and clears the data read by the GOT while the bar code reader is connected.
	M10	When set to ON, sets to OFF the M8.

*1 The PLC gives instructions to the GOT. Coils are turned ON/OFF in the PLC programs.

*2 The GOT transmits the information to the PLC. Contacts are used in the PLC programs.

Details of word devices

- Occupied word devices are used to specify screen numbers to be displayed and confirm the screens currently displayed.

[When data register D0 is assigned]

Data register	Contents of control
D0 D1 D2	These data registers specify screen numbers to be displayed. D0: Specifies the screen number of the base screen displayed when only one screen is displayed. D1: Specifies the screen number of overlaying screen 1 displayed when two screens are displayed. D2: Specifies the screen number of overlaying screen 2 displayed when three screens are displayed.
D3 D4 D5	These data registers store screen numbers of the screens currently being displayed. D3: Stores the screen number of the base screen currently being displayed. D4: Stores the screen number of the second screen currently being displayed. D5: Stores the screen number of the third screen currently being displayed.
D6	This word device specifies a file number to be read/written.
D7	This word device indicates the ID of the object whose input is completed.

- Interface Devices execute the following operations.
When bit devices M0 to M10, word devices D0 to D7 are assigned

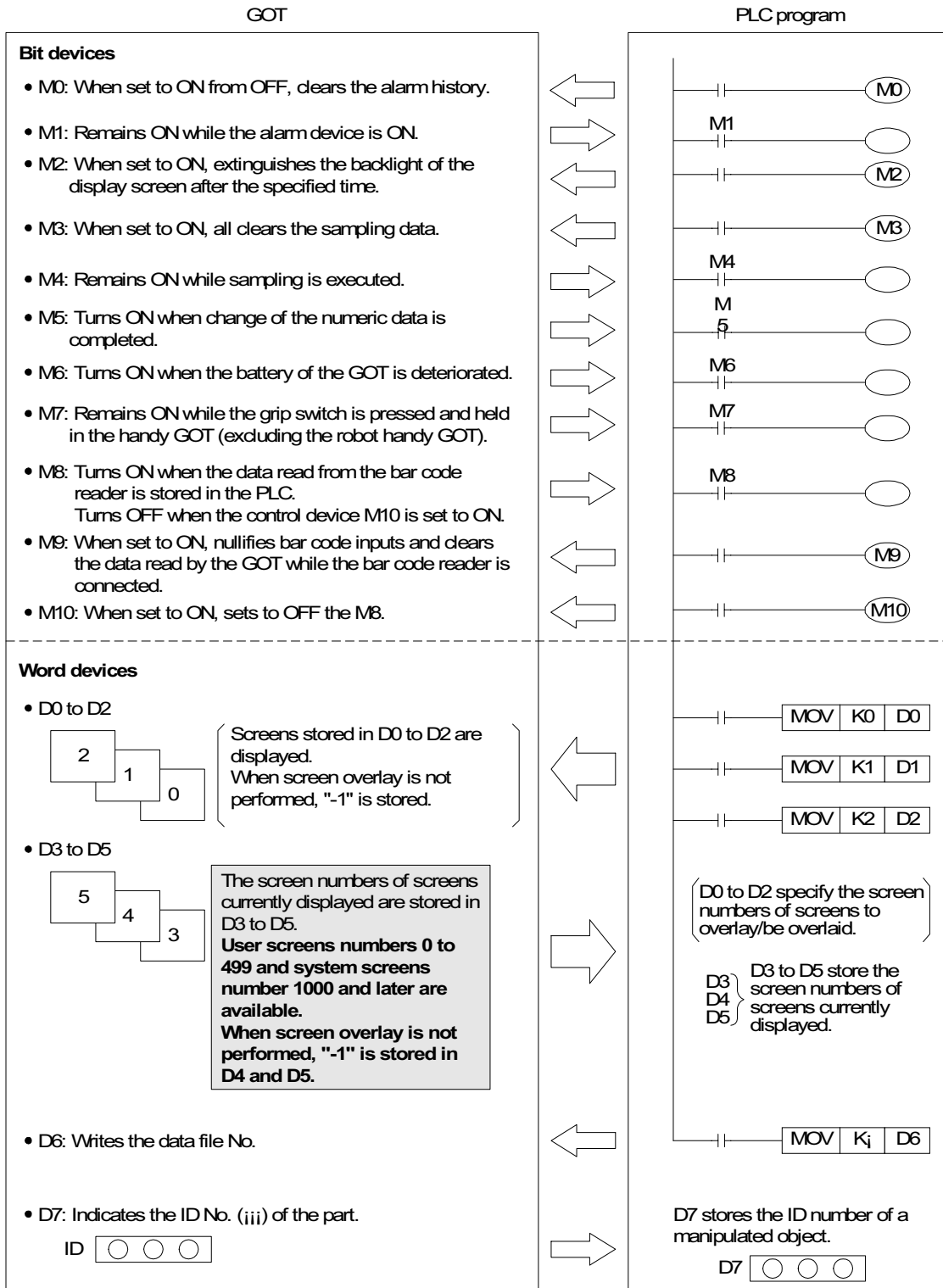

6.6.2 System Information (setting in GT Designer)

The following word devices can be specified as System Information devices for read and write.

- Read devices (PLC to GOT):
One or two 16-bit word devices are occupied.
(No devices are set when the GOT is shipped from the factory. The number of occupied devices can be changed using the screen creation software.)
- Head of specified word devices:
Reads the GOT information to bits 0 to 8 (b0 to b8).
"Head +1":
Specifies the recipe number to be read from/written to the PLC using the recipe function.

[When data register D10 is assigned]

Data register	Contents of control	
D10	b0	When set to ON from OFF, clears the alarm history of the GOT.
	b1	When set to ON, extinguishes the backlight of the display screen after the specified time.
	b2	When set to ON from OFF, clears the sampling data acquired in the sampling mode.
	b5	When set to ON, nullifies bar cod inputs and clears the data read by the GOT while the bar code reader is connected.
	b6	When set to ON, sets to OFF the bit 5 of the write device $D\Box+4$.
	b8	When set to ON, automatically displays the keyboard for inputting the password when a screen at higher security level is displayed. *1
D11	Specifies the recipe No. to be read from and written to the PLC by the recipe function. Set a recipe number of a recipe file created by the GT Designer subtracted by "1". Example: When reading or writing the recipe file number 1, write "0" to D11.	

*1 In F930GOT-K: From the first product, In F930GOT and F933GOT: V4.00 or later,
F940GOT, F943GOT: V6.00 or later,
F940WGOT: V1.00 or later
In F920GOT-K, the entry code input keyboard is displayed automatically without regard to the status of the system information.

- Write devices:
Five 16-bit word devices are occupied.
(Fifteen word devices are occupied in principle in the screen creation software. However, write devices not used in the GOT can be used as general word devices.)
No devices are set when the GOT is shipped from the factory.
- Head to "Head +2" of specified word devices: Store the screen numbers currently displayed.
"Head +3": Stores the object ID whose input is completed (Numerical Input, Ascii Input).
"Head +4": Turns ON/OFF its bits 0 to 8 (b0 to b8) to control the GOT.

[When data register D20 is assigned]

Data register	Contents of control	
D20 D21 D22	Store the screen Nos. displayed in the screen mode. D20: Stores the screen No. currently displayed. D21: Stores the screen No. of the second screen when two or more screens are overlapped (overlap window 1). D22: Stores the screen No. of the third screen when three or more screens are overlapped (overlap window 2).	
D23	Stores the object ID whose input is completed.	
D24	b0	Remains ON while the device assigned by the alarm function is ON.
	b1	Remains ON while sampling is executed in the sampling mode.
	b2	Turns ON when numeric value setting is completed.
	b3	Turns ON when the battery of the GOT is deteriorated.
	b4	Remains ON while the grip switch is pressed and held in the handy GOT (excluding the robot handy GOT).
	b5	Turns ON when the data read from the bar code reader is stored in the PLC. When the bit 6 of the read device D□+0 is set to ON, the bit 5 of the write device D□+4 is set to OFF.
	b8	Remains ON while data is changed by numeric inputs or ASCII inputs. *1
D25 to D34	Unused (Can be used as general word devices in sequence programs.)	

*1 In F920GOT-K and F930GOT-K: From the first product, In F930GOT and F933GOT: V4.00 or later, F940GOT, F943GOT: V6.00 or later, F940WGOT: V1.00 or later

- Device assigned for System Information execute the following operations.

When the following devices are assigned

Read devices : D10 (b0 to b2 are developed to M10 to M12.)
D11

Write devices : D20 to D24 (b0 to b11 of D24 are developed to M20 to M31.)) are assigned.

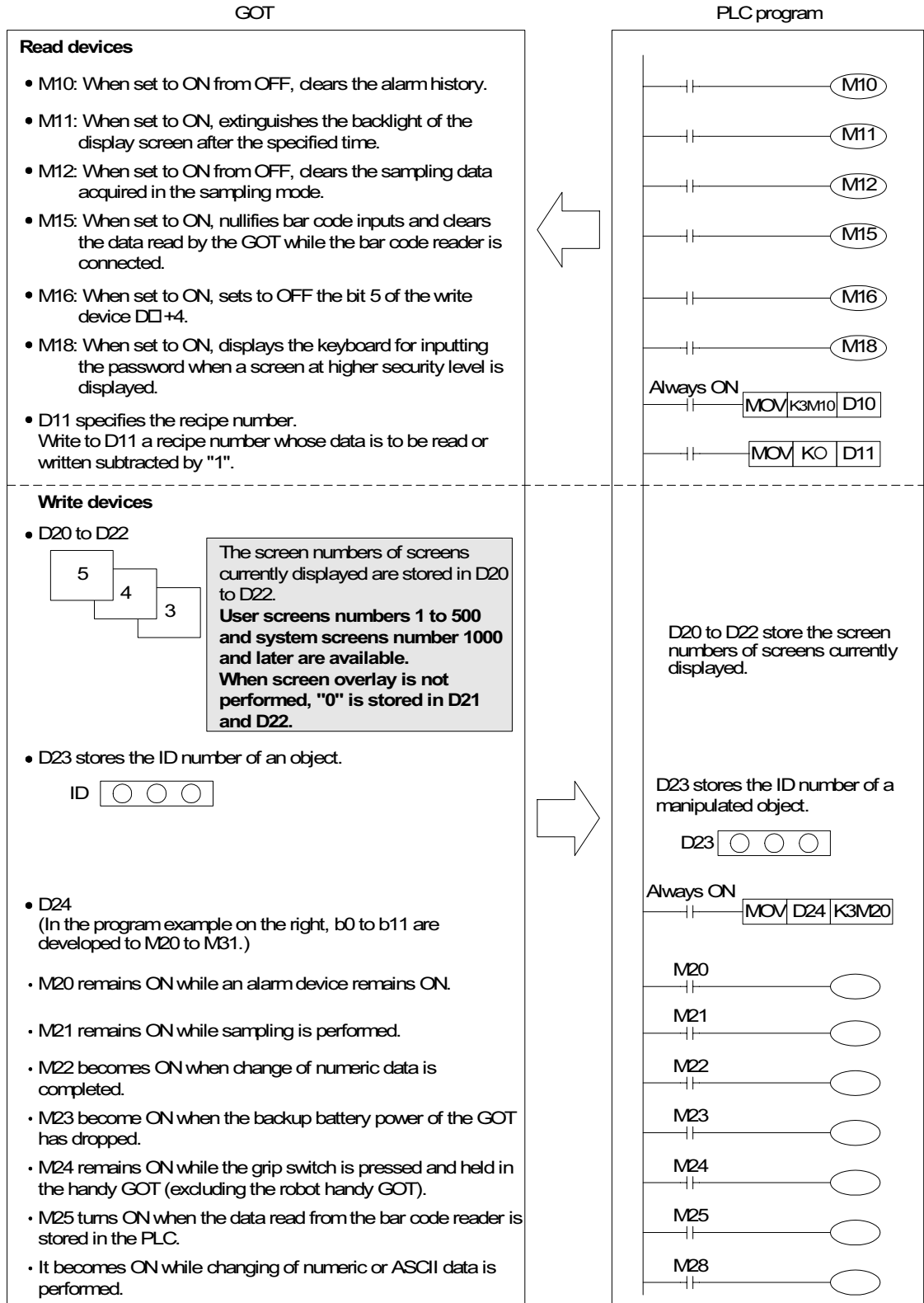

7. USER SCREEN MODE



DANGER

- Incorrect operation of the touch key(s) may lead to a serious accident if the GOT backlight has failed.

When the GOT backlight fails, the display section turns black and causes the monitor screen to appear blank, while the input of the touch key(s) still remain active.

Hence, confusing an operator in thinking that the backlight OFF function on the GOT is effective, then may try to display the screen again by touching the display section causing touch key operation.

Note that the following occurs on the GOT when the backlight fails:

- The monitor screen disappears even when the backlight OFF function is not set.
- The monitor screen will not come back ON from touching the display section, even if the backlight OFF function is set.
- Read the manual thoroughly and confirm the safety sufficiently before changing the data or turning ON or OFF a bit device.
Otherwise, an erroneous operation may damage the machine or cause an accident.

This chapter describes the mode in which user screens are displayed.

Confirm the outline of what can be displayed and the operating procedures in USER SCREEN MODE.

For contents related to the screen design, refer to Chapters 19 to 22.

7.1 Display format

F920GOT-K

- Horizontal display is available.

F930GOT-K

- Horizontal display is available.

F930GOT, F933GOT

- Horizontal or vertical display is available.

F940GOT, F943GOT

- Only horizontal display is available.

F940WGOT

- When using FX-PCS-DU/WIN-E, horizontal or vertical display is available.
When using GT Designer, divided display (main screen and sub screen) is available in addition to horizontal and vertical display.
- The display can be divided in two having a sub screen either on the right or left side, or into three having sub screens on both sides.
- Only one kind of display is selected for a sub screen (sub screens cannot be changed but the main screen can).
- The following items are displayed on the sub screen when Divided (left) or Divided (right) is selected. Only customized sub screens are displayed, however, when choosing Divided (both).
 - Keyboard : The decimal key, hexadecimal key, or character key is displayed according to the objects to be changed (Numerical Input or Ascii Input).
The keyboard display is selected between a system keyboard or a created custom keyboard.
 - Alarm history : The Alarm history is displayed.
 - Alarm list : The Alarm list is displayed.
 - Alarm frequency : The Alarm frequency is displayed.
 - Customized sub screen : The screen configuration objects such as a character string, numerical value or touch key can be displayed.
- The dot pitch of F940GOT is 0.324 (horizontal) × 0.375 (vertical), therefore, displayed items have a length to height ratio of about 1:1.16.

7.2 Display size

F920GOT-K

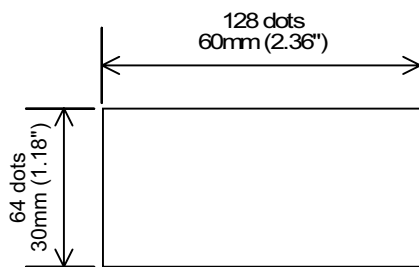

F930GOT, F933GOT, F930GOT-K (Horizontal display)

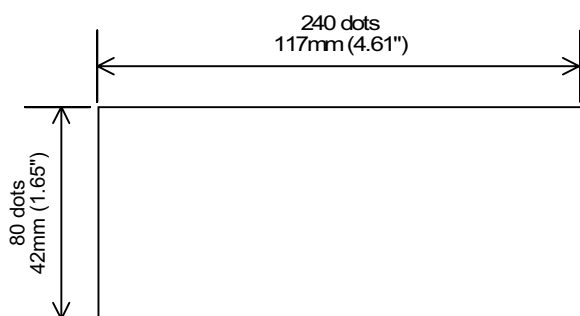

F930GOT, F933GOT (Vertical display)

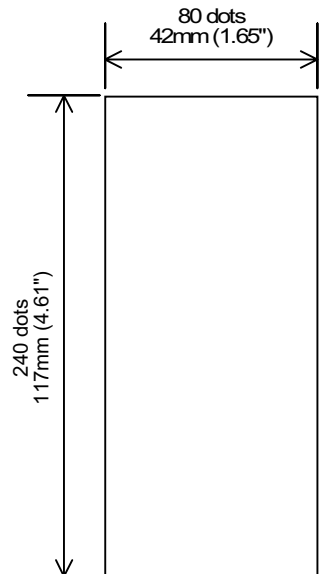

F940GOT, F943GOT

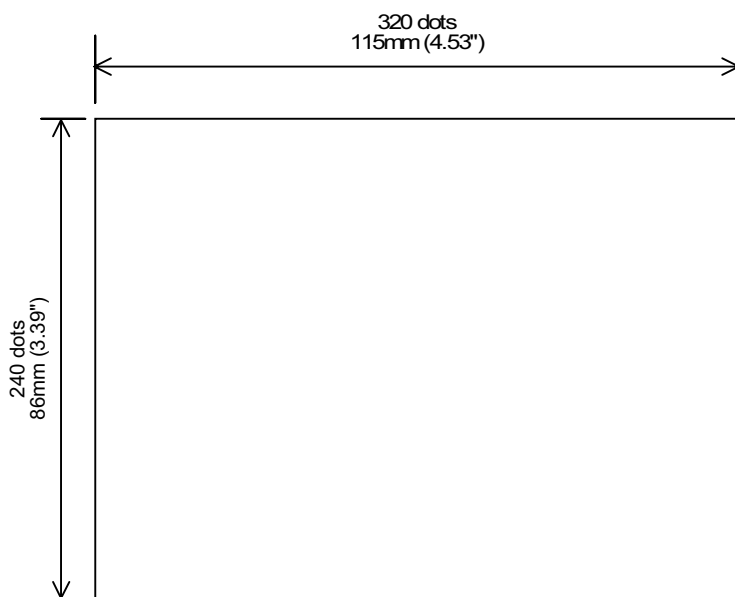

F940WGOT (Horizontal display)

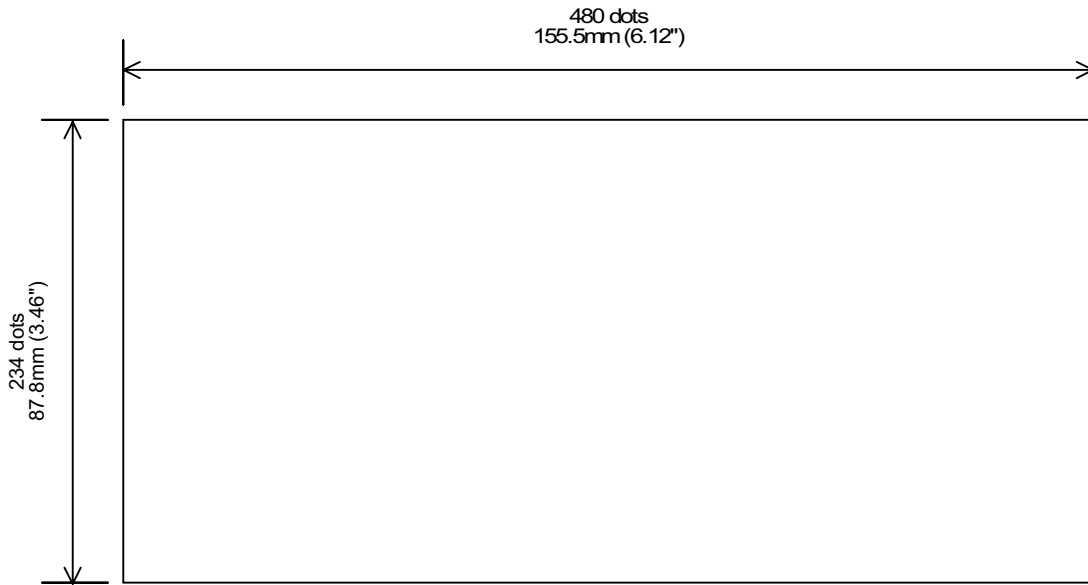

F940WGOT (Vertical display)

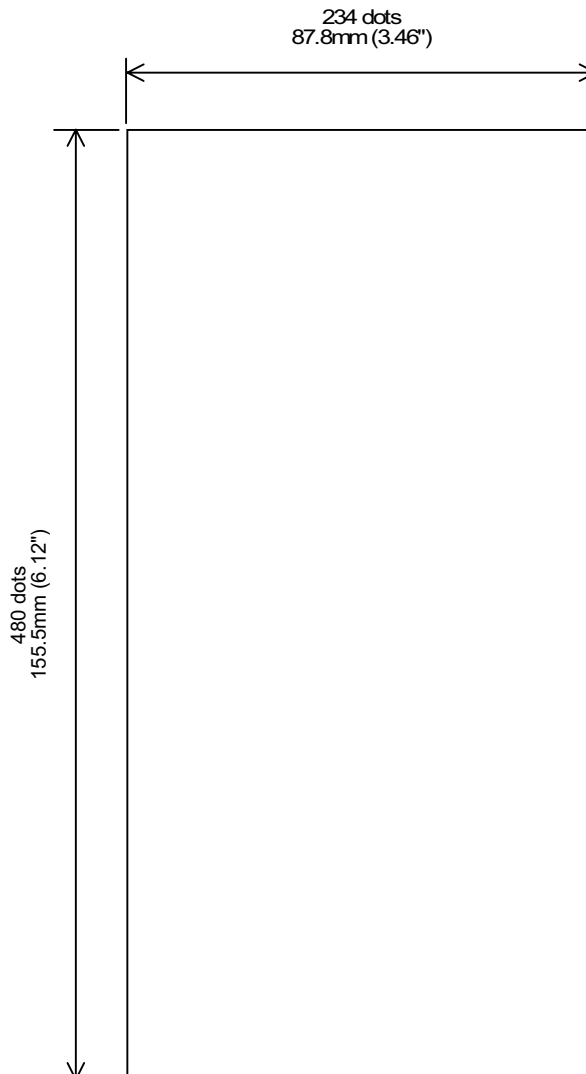

F940WGOT Divided display (left/right)

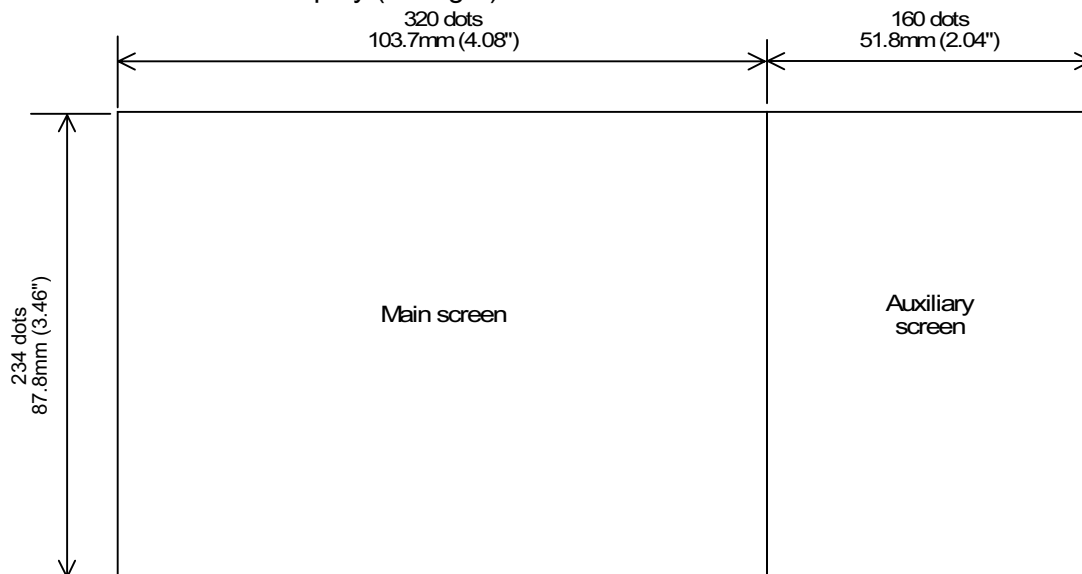

- If the position of the screens is switched, the number of dots is the same as above.

F940WGOT Divided display (both)

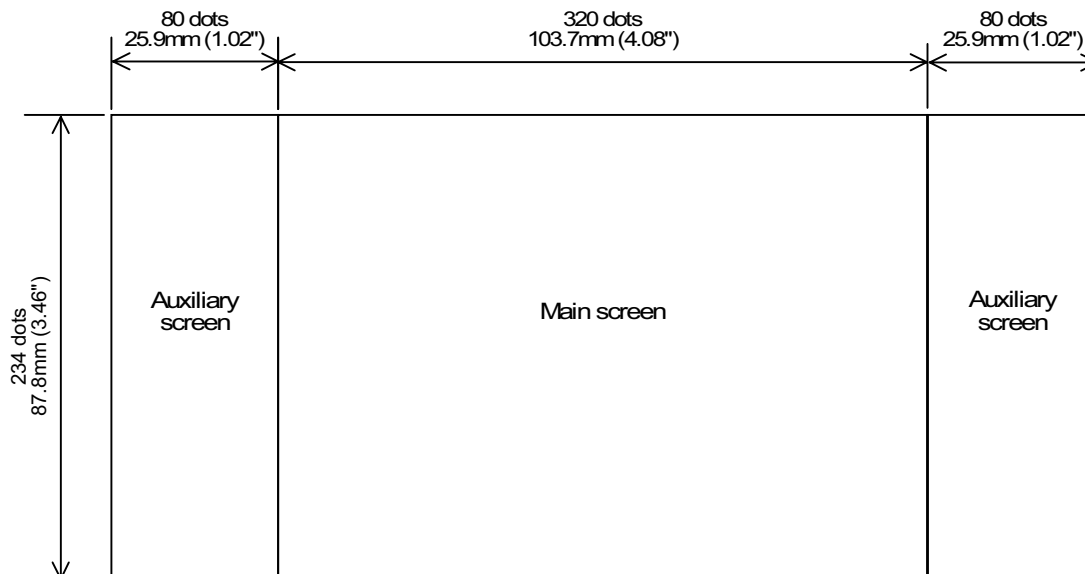

- The divided display is available only when using GT Designer.

7.3 Outline of USER SCREEN MODE

In the USER SCREEN MODE, screens created by the user or alarm messages are displayed. On one screen, characters, straight lines, rectangles, circles, etc. which are classified in accordance with their functions are combined and displayed. When there are two or more user screens, they can be changed over using operation keys in the GOT or using the PLC. (The user can set the condition to change over the screens and the screen to be displayed next.)

Example of display screen (F940GOT)

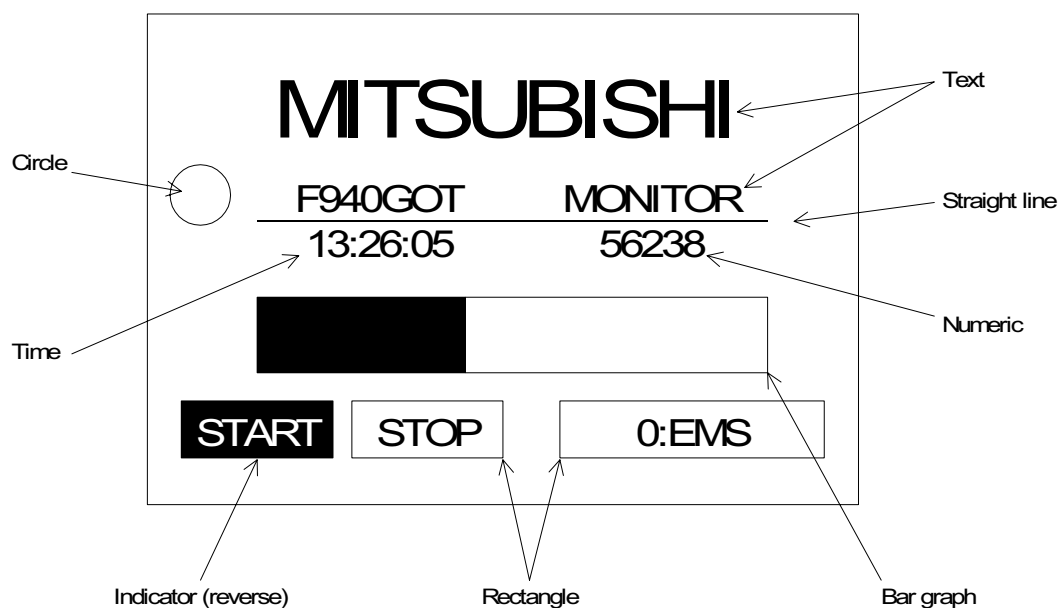

The functions used in the display example on the previous page can be mainly classified into four types as shown below.

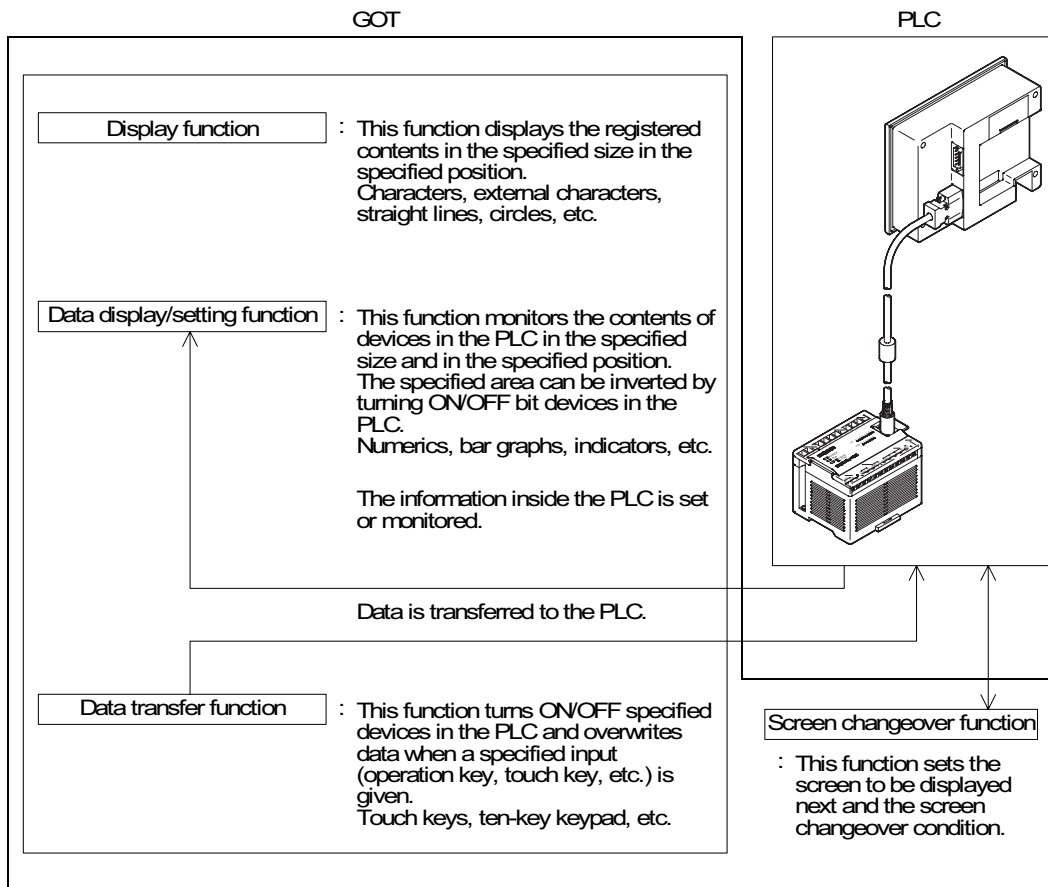

7.4 Number of registered screen construction elements

Number of registered screen construction elements (Common to F920GOT-K, F930GOT-K, F930GOT, F933GOT, F940GOT, F943GOT and F940WGOT)

Screen construction element name		Number of registered objects			
		[A]	[B]	[B']	[C]
GT Designer	FX-PCS-DU/ WIN-E	Per screen	Common set screen	Screen call	Viewable for screen display
ASCII display	ASCII	10	10	10	10
ASCII input					
Numerical Display	Number				
Numerical Input					
Comment display (word specification)	Library Text	50	50	50	50
Bar graph	Bar graph				
Part Display (word specification)	Library Image				
—	Circle graph				
Panel meter	Panel meter				
Statistics graph	Proportional bar graph				
	Proportional Pie graph				
Trend graph	Trend Graph	1	1	1	1
Line graph	Line Graph	1	1	1	1
Comment display (bit specification)	Text Indicator	50	50	50	50
Lamp	Indicator				
	Overlay Screen				
	Label Indication				
Part Display (bit specification)	Image Indication				
—	Buzzer				
Clock display	Date	10	10	10	10
	Time				

Screen construction element name		Number of registered objects			
		[A]	[B]	[B']	[C]
GT Designer	FX-PCS-DU/ WIN-E	Per screen	Common set screen	Screen call	Viewable for screen display
Touch key	Switch	50	50	50	50
	Send Databank				
	Increment				
	Decrement				
	Data Setting	50	50	50	50
	Change Screen				
	Write constant				
Touch key					
Panel kit	Keyboard	1	1	1	1
Alarm history display	Alarm History display	1	1	1	1
Alarm list display (user alarm)	Alarm List (user alarm)	1	1	1	1
Floating Alarm display	Moving Alarm display	1	1	1	1

The maximum objects viewable for one screen display is shown in [C]. The configuration is as follows: $[A] + [B] + [B'] \leq [C]$

When overlay is performed using the screen overlay function or lamp (screen) function, the number of viewable objects is also as shown in [C].

*1 When using the F920GOT-K, the function keys are regarded as the 'external keys' and each function is allocated to it.

- The F920GOT-K is not equipped with a touch key.

Number of objects registered in library

Library name	Number
Text library	2000
Image library	2000

Data capacity

Item	Description
Full-screen data size	128 kbyte (user screen, external characters, etc.) ... F920GOT-K
	256 kbyte (user screen, external characters, etc.) ... F930GOT, F933GOT
	512 kbyte (user screen, external characters, etc.) ... F940GOT, F943GOT
	1 Mbyte (user screen, external characters, etc.) ... F940WGOT

7.5 Change of displayed data

Among the data displayed on the user screen, numeric data indicating set values and current values of word devices in the PLC can be changed by operating the touch key or key-pad. In FX-PCS-DU/WIN-E, "Number" and "Ascii" can be changed. In GT Designer, "Numerical Input" and "Ascii input" can be changed.

7.5.1 Data change condition

In the following cases, Number (Numerical Input), Ascii (Ascii Input), or Bar Graph (Bar) cannot be changed.

1) GOT status

- While change is forbidden (During communication with FX-PCS-DU/WIN-E)
When the data change target object is set to "FORBID".
Countermeasures: Set the object to "PERMIT".
- When an input value is outside the allowable range
The upper limit and lower limit are provided to indicate the allowable data setting range. If the input value is outside this range, it is not accepted.
Countermeasures: Change the upper/lower limit value.
- When "*****" is displayed on the screen (Only in HPP MODE. It is blank on a user screen.)
When a device number not existing in the PLC is monitored, the numeric data is displayed as "*****" on the screen.
Countermeasures:
Change the device number whose numeric data is to be monitored on the screen.
- If the displayed "Number" ("Numerical Input") or "Ascii" ("Ascii Input") is not located in a position recognizable as mesh for touch key
A touch key can occupy an area of 16 (width) x 20 (height) dots. When a touch key occupies the half or more of this area, it is recognized as a touch key. If a target object of data change is not located in a position recognizable as mesh for touch key, the data change operation is disabled even if the target object of data change is touched.
Solution:
Change the location of the target object. Or display the target object with a frame or in a size whose height is twice or more. (Refer to Paragraph 19.6.1 and 21.9.1.)
- When displaying the key window in the F930GOT-K, (During communication with GT Designer) set "Key window setting" on the "Key window" tab on the "Project Auxiliary Settings" dialog box.
The key window is not displayed if "Use default key window" is selected on the "Key window" tab. (Refer to Paragraph 7.6.3.)

For the three countermeasures above, numeric setting should be changed in the screen creation software.

2) PLC status

- When the FX/A Series PLC, set values of timers, counters and current values of file registers cannot be changed.
- When the FX Series PLC is in RUN, set values of timers, counters and current values of file registers cannot be changed.
- When an entry code is registered in the FX/A Series PLC, set values of timers, counters and current values of file registers cannot be changed. Reset the entry code.

7.6 Data change using touch keys

In the F930GOT, F933GOT, F940GOT, F943GOT and F940WGOT, change the display data values using the touch keys. (The F920GOT-K is not equipped with any touch key.)

In the F930GOT-K, change the display data using the touch keys or the key pad.

For data change using the key pad, refer to Paragraph 7.7.

7.6.1 Common items in data change using touch keys

This paragraph describes the common items when numeric values and character code data are changed using the touch keys.

- When changing "Number" ("Numerical Input") or "Ascii" ("Ascii Input"), touch the touch key indicating "Number" ("Numerical Input") or "Ascii" ("Ascii Input") on the display screen to enable the data change operation.

*1 In the FX-PCS-DU/WIN-E, "Data Changeable" is required to be selected for "Number" and "Ascii".

In the GT Designer, data change is valid for "Numerical Input" and "Ascii Input".

- A numeric value can be input from the keyboard for numeric input always displayed on the screen, or from the keyboard which can be called and manipulated upon necessity.
- The screen creation software can create a keyboard by assigning key codes to touch keys.

7.6.2 Data change procedure using touch key

[When the keyboard is always displayed]

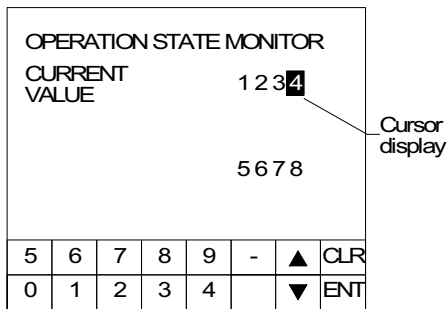

[When the keyboard is called]

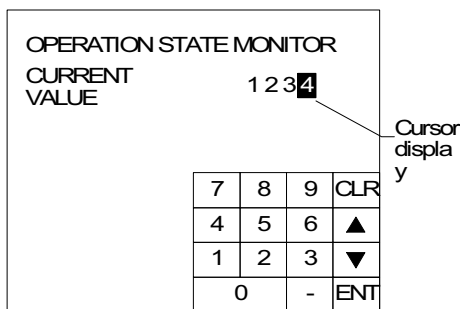

- When a numeric or ASCII code displayed on the screen is touched, a cursor is displayed and the numeric or ASCII code can be changed using the on screen keyboard. When GT Designer is used, "Project" in "Auxiliary Setting" in "Common" should have been set so that the key window is open.
- Press the CLR key to cancel the input. Press the ENT key to execute the input.
- When selecting another numeric or ASCII code, touch it on the screen or select it using the ▲ and ▼ keys.
- If the keyboard is not displayed on screen, when a numeric or ASCII code touched, the ten-key keypad is displayed as shown on the left so that numerics can be entered.
- Specifying the keyboard design
 FX-PCS-DU/WIN-E: Select ten keys to use on the setting screen for "Data Setting" object.
 GT Designer: After creating ten keys on the window, select an window to be used for "Project" in "Auxiliary Settings". (Refer to 19.1.)
- The ten-key window is initially fixed to display in the lower hight. However, it can be moved by touching the position where it should be next after touching the upper part of the window.

7.6.3 Key window display in F930GOT-K

When using FX-PCS-DU/WIN:

The key window is displayed when a number or character on the screen is touched.

An object for data change can be allocated to a touch key or function key, and a key window can be displayed.

When using GT Designer:

When displaying the key window in the F930GOT-K, set the keys using "Screen" and "Project" available by selection of "Common" → "Auxiliary Setting" from the menu bar in the screen creation software (GT Designer).

When deleting the displayed ten-keys, set the "Project Auxiliary Settings" dialog box.

"Project Auxiliary Settings" dialog box

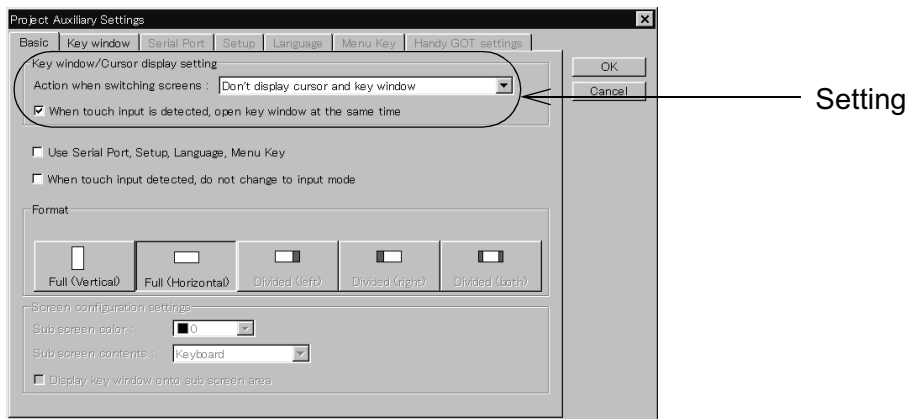

- When displaying the key window at screen changeover

Setting: "Action when switching screens" in "Key window/Cursor display setting"

Select "Display cursor and key window".

At screen changeover, the cursor is displayed in "Numerical Input" or "Ascii Input" satisfying the operation condition and located in the most upper left position.

In addition, the key window is displayed, and the data can be changed using the touch keys.

The displayed key window varies depending on the setting on the "Key window" tab on the "Display cursor and key window" dialog box.

Setting ("Key window" tab)	Decimal	Hexadecimal	ASCII
When selecting "Use default key window"	Only the cursor is displayed.	Only the cursor is displayed.	Only the cursor is displayed.
When specified key window does not exist	Only the cursor is displayed.	The cursor and the key window held by the system are displayed.	The cursor and the key window held by the system are displayed.

Setting ("Key window" tab)	Decimal	Hexadecimal	ASCII
When selecting number 0 under "Select key window sheet No."	Only the cursor is displayed.	Only the cursor is displayed.	Only the cursor is displayed.
When key window is created and its number is selected under "Select key window sheet No."	The cursor and the set key window are displayed.	The cursor and the set key window are displayed.	The cursor and the set key window are displayed.

- When displaying the key window by touching numbers or Ascii code input

Setting: Select "When touch input is detected open key window at the same time" under "Key window/Cursor display setting", so that a key window and cursor is displayed by touching the numerical parts or Ascii parts on the display and data change by a touch key is enabled.

The key window to display can be specified after clicking "Key window" tab in "Project Auxiliary Settings" dialog box.

Setting ("Key window" tab)	Decimal	Hexadecimal	ASCII
When selecting "Use default key window"	Only the cursor is displayed.	Only the cursor is displayed.	Only the cursor is displayed.
When specified key window does not exist	Only the cursor is displayed.	The cursor and the key window held by the system are displayed.	The cursor and the key window held by the system are displayed.
When selecting number 0 under "Select key window sheet No."	Only the cursor is displayed.	Only the cursor is displayed.	Only the cursor is displayed.
When key window is created and its number is selected under "Select key window sheet No."	The cursor and the set key window are displayed.	The cursor and the set key window are displayed.	The cursor and the set key window are displayed.

- Closing the Key window

The key window is closed by the setting in "Screen Auxiliary Setting" dialog box.

"Screen Auxiliary Setting" dialog box

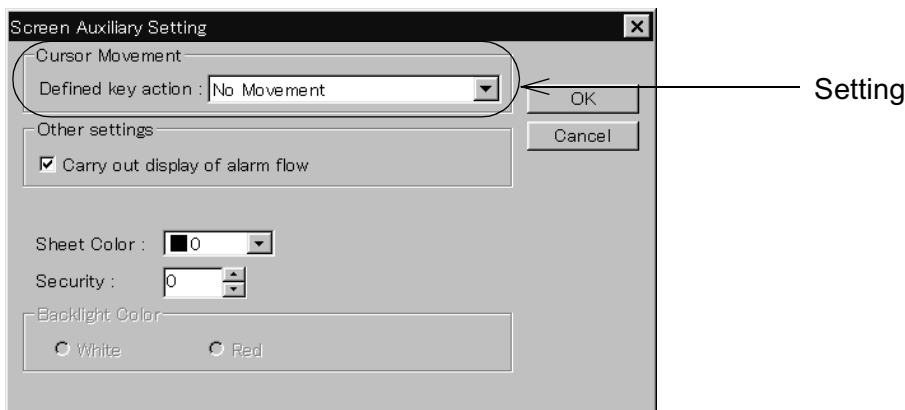

- Setting: Select "Defined key action" for "Clear cursor and key window", so that the key window is closed when the ENT key is pressed after a number or Ascii code is entered.

7.6.4 Decimal point input function

Decimal points can be entered if a touch key to which the key code for decimal point (002E) is assigned is included when data change is performed.

Applicable version

GOT

Product model name	Version
F930GOT, F933GOT	V4.00 or later
F930GOT-K	From first product
F940GOT, F943GOT	V6.00 or later
F940WGOT	V1.00 or later

Screen creation software

Software name	Applicable version
GT Designer	SW1D5C-GOTR-PACKE(A) or later
FX-PCS-DU/WIN-E	V2.00 or later

* Decimal points cannot be entered in a key window displayed in the standard form. It is necessary to create a key window using the key window customizing function (refer to 7.5.4) or display a keyboard including a touch key for decimal point on the screen.

- Display example of numeric input: Display device D100, signed decimal number

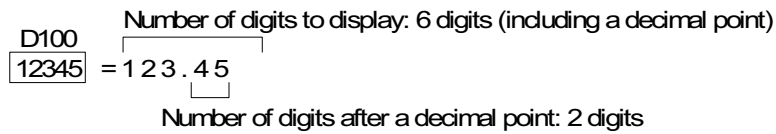

When changing to 12.30

With a touch switch for decimal point
Enter [1][2][.][3].

Without a touch switch for decimal point
Enter [1][2][3][0].

* "1230" is entered into the PLC (D100) whether a decimal point exists or not.

Note: Decimal point input does not mean changing the display position of a decimal point arbitrarily.

The set number of digits to display and number of digits after a decimal point cannot be exceeded when entering numbers.

7.6.5 Key window display position specification

The initial position of the ten-key window displayed when changing data for numeric input or ASCII input is in the lower right. In the case of the following versions or later of GOT and screen creation software, this display position can be specified.

Applicable version

GOT

Product model name	Version
F930GOT, F933GOT	V2.00 or later
F930GOT-K	From first product
F940GOT, F943GOT	V3.00 or later
F940WGOT	V1.00 or later

Screen creation software

Software name	Applicable version
GT Designer	SW5D5C-GOTR-PACKE(A) or later
FX-PCS-DU/WIN-E	Cannot be used

- The key window display position for each screen is set in "Window Position" in "Draw" in GT Designer.

Basic operation

- On the same screen a key window will always open in the same position as it was last closed. If the screen is displayed for the first time, the key windows will appear in its set position.
- If the screen is changed over and back again, the key window will appear in its set position.
- On a screen for which the key window initial position is not set, the window is always displayed in the lower right corner.
- When a key window's initial position is set to where it is protruding from the screen, the initial position start coordinate is corrected so that the entire key window can be displayed on the screen. (Refer to the figure below.)

When "X: 0, Y: 100" are set

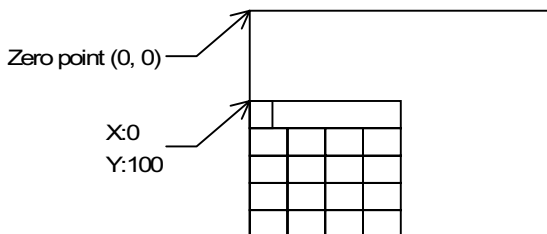

- The zero point in this coordinate system is located at the upper left corner of the screen.

When "X: 160, Y: 100" or larger coordinates are set

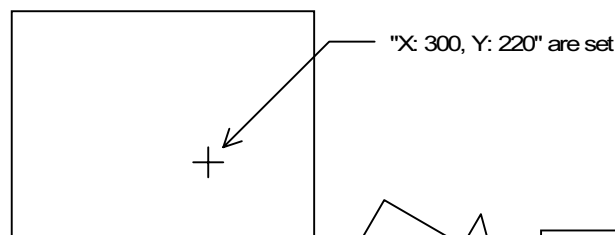

- In the above setting, the key window is protruding from the screen.

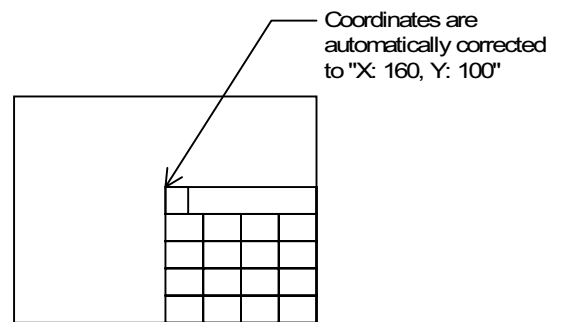
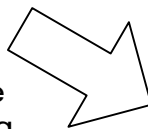

- The upper left corner coordinates are automatically corrected so that the entire key window can be displayed on screen.

7.6.6 Creation of key window

In the following versions or later of the GOT and screen creation software, windows other than the standard-equipped decimal key, hexadecimal key and ASCII key windows can be created and displayed.

Applicable version

GOT

Product model name	Version
F930GOT, F933GOT	V4.10 or later
F920GOT-K	From first product
F940GOT, F943GOT	V3.00 or later
F940WGOT	V1.00 or later

Screen creation software

Software name	Applicable version
GT Designer	SW3D5C-GOTR-PACKE(A) or later (F930GOT: SW5D5C-GOTR-PACKE(5.09K) or later)
FX-PCS-DU/WIN-E	Cannot be used

Creating procedure in GT Designer

- 1) In "New Screen" in "Screen", display the screen creation window.
- 2) Change "Screen type" to "Window".
- 3) Input the screen "No." to be created.
(You can create up to 500 screens from No.1 to No. 500.)
The screen number you input here is treated as the decimal/hexadecimal/ASCII key window screen No. in "Key Window Screen No." described in the previous section.
 - Key window screen numbers are from 1 to 500 in the same way as base screens. "W" is added to the number in the screen list in the test mode of the main body (Refer to Chapter 11) so that the key window screen number can be distinguished from the base screen number
- 4) Input the screen size.
 - F940WGOT, F940GOT
X axis: Within the range of 94 to 318 dots in increments of 8 dots
Y axis: Within the range of 81 to 220 dots in increments of 8 dots
 - F930GOT, F933GOT, F930GOT-K
X axis: Within the range of 10 to 240 dots in increments of 1 dot
Y axis: Within the range of 20 to 80 dots in increments of 1 dot

* Once you open the screen, you can enlarge or reduce the screen using the mouse by selecting "Edit" in "Change Size" in "Screen".
- 5) You can put characters and touch keys on each key window screen in the same way as base screens. However, the following objects are not available on key window screens.
 - Numerical Input ("Numerical Display" is available.)
 - Ascii Input ("Ascii Display" is available)
 - Line Graph
 - Alarm History Display
 - Alarm List Display
 - Trend Graph
- 6) Using GD12 as Numerical display, numerical or Ascii data can be displayed concurrently while it is being input (Echo display).

Rules and cautions on display (As for the F930GOT-K, refer to Section 7.6.3.)

Operation is performed as follows depending on absence/presence of the screen number of the key window to be displayed.

- 1) When the screen number is not set in "Key Window Screen No." or when the screen number is set to "0", no setting is made.
 - The decimal keyboard is always displayed without regard to Format ("Numeric Input" or "ASCII Input"). This operation is equivalent to that in Ver. 3.00 or earlier.

- 2) When the key window screen is created but it cannot be displayed due to errors on it or when there is not a key window with the specified screen number to display:
 - "Numeric Input" (other than hexadecimal number): The decimal keyboard is displayed.
 - "Numeric Input" (hexadecimal number): The hexadecimal keyboard is displayed.
 - "ASCII Input": The ASCII keyboard is displayed.

- 3) When there is a key window with the screen number set in "Key Window Screen No.":
 - "Numeric Input" (other than hexadecimal number):
The key window with the screen number specified in "DEC key sheet No." is displayed.
 - "Numeric Input" (hexadecimal number):
The key window with the screen number specified in "HEX key sheet No." is displayed.
 - "ASCII Input":
The key window with the screen number specified in "ASCII key sheet No." is displayed.

As the background of the key window is transparent, have in mind the following contents.

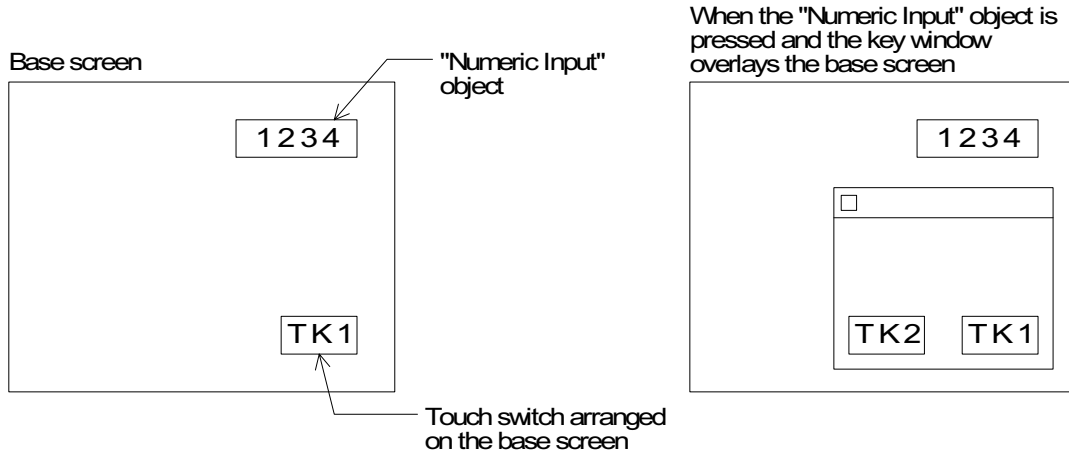

- Though "TK1" is a touch key set on the base screen, it is also displayed on the key window screen because the background of the key window is transparent. However, "TK1" is not recognized as a touch switch.
- If you would like to hide "TK1" on the key window, paint the background of the key window using a "Rectangle" object.

7.7 Data change using key pad (F920GOT-K and F930GOT-K)

Values of "Numerical Input" and "Ascii Input" (0 to 9) can be changed using the key pad in the F920GOT-K, or using the touch keys or the key pad in the F930GOT-K.

This paragraph explains the data change operation using the key pad.

For the data change operation using the touch keys in the F930GOT-K, refer to section 7.6.

7.7.1 Data change operation using key pad

The data change operation is valid for the following displayed objects:

- "Number" and "Ascii" created using the FX-PCS-DU/WIN-E
In this case, it is required to select "Data Changeable" in advance for "Number" or "Ascii" to be changed.
- "Numerical Input" and "Ascii Input" created using the GT Designer

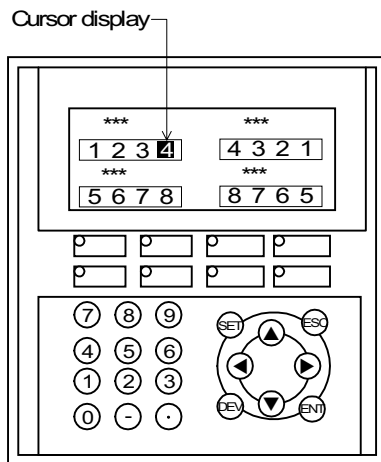

- "SET" key: displays the cursor.
When the SET key is pressed, the cursor is displayed and data change is enabled.
The cursor is displayed in a data change target object located in the upper left position. (Only objects satisfying the operation condition are regarded as data change targets.)
- "◀", "▶", "▲" and "▼" keys: Select the target object.
By using these keys, select a target object whose data is to be changed.
- "0" to "9", "-", and "." keys: Enter a numeric value.
By using these keys, enter a numeric value.
Use the "-" key to input a negative value. Use the "." key to input the decimal point.
- "ESC" key: Cancels the data change operation.
When this key is pressed, the previous numeric value before change is displayed again.
- "ENT" key: Determines the input numeric value.
When this key is pressed, the input numeric value is determined and written to the PLC.
- "DEV" key: Not used.

Data change operation

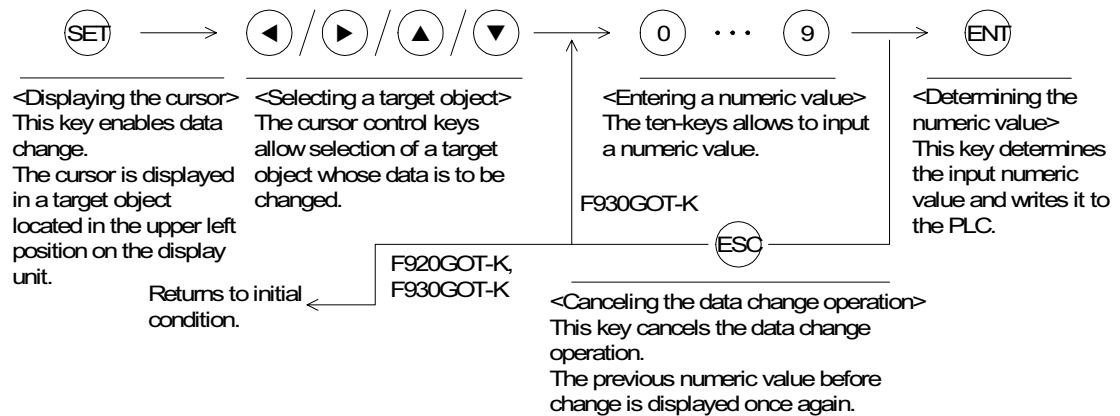

- In the F920GOT-K, the initial condition is obtained (the cursor is cleared) when the ESC key is pressed while operating the numerical input.
In the F930GOT-K, the operation is set for Defined key operation in the Screen Auxiliary Setting dialog box when ESC is pressed.
- If any character other than "0" to "9", "-" and "." is required to be entered as "Ascii Input" in the F930GOT-K, enter it from the key window. (Refer to Section 7.6.3).
- In the F920GOT-K, any character other than "0" to "9", "-" and "." cannot be entered.
- When entering hexadecimal numbers in the F920GOT-K, switch from decimal input mode to HEX input mode by pressing the "." key.
In the HEX input mode (when HEX is displayed on the right on the screen), "A", "B", "C" ... and "F" are entered when "1", "2", "3" ... and "6" keys are pressed respectively.
- The "." key for the decimal point on the key pad is invalid while a key window without the decimal point is displayed.
When inputting the decimal point from the key pad, do not display such a key window without the decimal point, or display a key window with the decimal point.

7.7.2 Cursor key operation

- Displaying the cursor

When FX-PCS-DU/WIN-E is used:

Settings in the screen creation software are unavailable.

The cursor is displayed when the "Number" or "Ascii display" is touched or the SET key is pressed.

When GT Designer is used:

In the data change operation using the key pad, the display and operation of the cursor varies depending on the settings in the screen creation software.

Perform the settings in "Project" available from selecting of "Common" → "Auxiliary Setting" from the menu bar from the screen creation software.

"Project Auxiliary Settings" dialog box

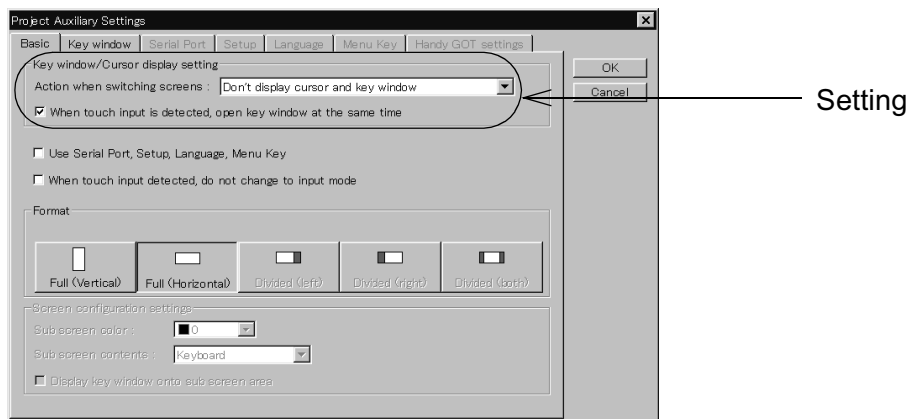

Setting: "Action when switching screens" in "Key window/Cursor display setting"

- When selecting "Don't display cursor and key window"
When the screen is changed over, the cursor and the key window are not displayed.
When entering a numeric value, press the "SET" key to display the cursor.
- When selecting "Display cursor only"
When the screen is changed over, the cursor is displayed in "Numerical Input" or "Ascii Input" satisfying the operation condition and located in the most upper left position.
(When entering a numeric value, pressing the "SET" key to display the cursor is not required.)
- When selecting "Display cursor and key window"
When the screen is changed over, the cursor is displayed in "Numerical Input" or "Ascii Input" satisfying the operation condition and located in the upper left position. (When inputting a numeric value, pressing of the "SET" key to display the cursor is not required.)
In addition, the key window is displayed, and the data can be changed using the touch keys.

Setting ("Key window" tab)	Decimal	Hexadecimal	ASCII
When selecting "Use default key window"	Only the cursor is displayed.	Only the cursor is displayed.	Only the cursor is displayed.
When specified key window does not exist	Only the cursor is displayed.	The cursor and the key window held by the system are displayed.	The cursor and the key window held by the system are displayed.
When selecting number 0 under "Select key window sheet No."	Only the cursor is displayed.	Only the cursor is displayed.	Only the cursor is displayed.
When key window is created and its number is selected under "Select key window sheet No."	The cursor and the set key window are displayed.	The cursor and the set key window are displayed.	The cursor and the set key window are displayed.

The key window to display can be specified after clicking "Key window" tab in "Project Auxiliary Settings" dialog box.

Do not select the above when using only the key-pad to change data.

(Not available in the F920GOT-K)

Setting ("Key window" tab)	Decimal	Hexadecimal	ASCII
When selecting "Use default key window"	Only the cursor is displayed.	Only the cursor is displayed.	Only the cursor is displayed.
When specified key window does not exist	Only the cursor is displayed.	The cursor and the key window held by the system are displayed.	The cursor and the key window held by the system are displayed.
When selecting number 0 under "Select key window sheet No."	Only the cursor is displayed.	Only the cursor is displayed.	Only the cursor is displayed.
When key window is created and its number is selected under "Select key window sheet No."	The cursor and the set key window are displayed.	The cursor and the set key window are displayed.	The cursor and the set key window are displayed.

- Moving and deleting the cursor

Moving the cursor using the cursor control keys

When selecting a target object using the cursor control keys, the cursor moves from the top right to the left and from the top to the bottom.

At this time, in the target object display position, the lower right corner of each object is regarded as the reference.

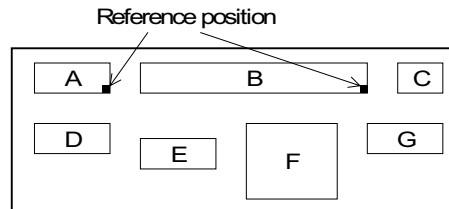

The cursor movement order by each cursor control key is as follows:

"▶" key : A → B → C → D → G → E → F → A

"▼" key : A → D → E → F → B → C → G → A

"◀" key : A → F → E → G → D → C → B → A

"▲" key : A → G → C → B → F → E → D → A

Moving and deleting the cursor using the "ENT" key

When FX-PCS-DU/WIN-E is used:

Settings in the screen creation software are unavailable.

The cursor is cleared when the ENT key is pressed.

When GT Designer is used:

The cursor moving and deleting operations vary depending on the setting on the "Screen Auxiliary Setting" dialog box.

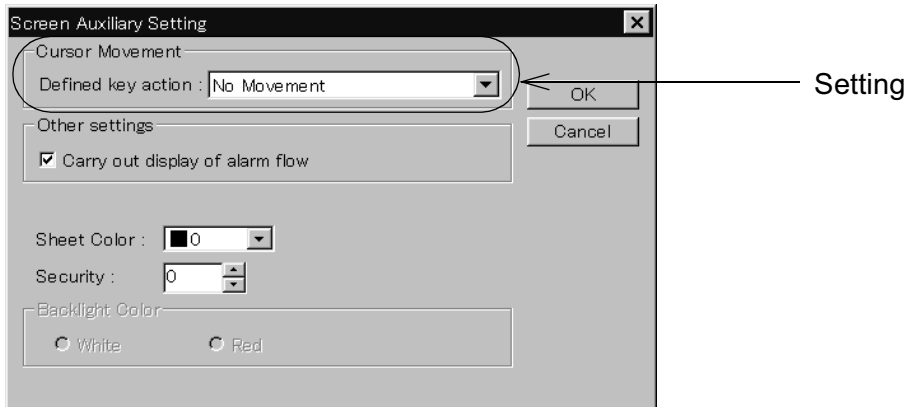
"Project Auxiliary Settings" dialog box**Setting: "Defined key action"**

- When selecting "No Movement"
Even if the "ENT" key is pressed after a numeric value is entered using the ten-keys, the cursor is not moved or deleted.
- When selecting "User ID order"
When the "ENT" key is pressed after a numeric value is entered using the ten-keys, the cursor is moved in the movement destination ID order set to each target object. (Set the movement destination ID on the "Numerical Input" or "Ascii Input" setting window.)
- When selecting "Clear cursor and key window"
When the "ENT" key is pressed after a numeric value is entered using the ten-keys, the cursor is deleted.
When performing the data change operation again, press the "SET" key to display the cursor again. At this time, the cursor is displayed again in a target object located in the upper left position.
- In the F920GOT-K, the cursor is cleared when the "ESC" key is pressed. In other models than the F920GOT-K, the cursor moves as defined under Cursor Movement in the Screen Auxiliary Setting dialog box when the "ESC" key is pressed.

7.8 Numeric setting completion flag and data changing flag

When data is being changed for "Number" ("Numerical Input") or "Ascii" ("Ascii Input") or the procedure is complete, the following devices turn ON.

At this time, the ID code is written to the PLC so that a device whose data is changed can be identified.

The numeric setting completion flag and data changing flag can be used in data change by both touch key and key-pad.

When FX-PCS-DU/WIN-E is used

1) Completion flag

When a screen is created using the FX-PCS-DU/WIN-E, a control device (described in Section 6.6.1) MO+5 turns ON as the completion flag.

Interface device

- MO+5
"O" indicates the head control device number.
For example, when the head control device is set to M10, M15 functions as the numeric setting completion flag.
* Control devices can be set using the screen creation software.

Operation

- When a current or set value of a word device is changed using the following objects, the flag turns ON.
Object names: "Data Change" and "Keyboard"
(The flag does not turn ON when the "Data+1", "Data-1" or "Constant" object is used.)
ON timing : The flag turns ON when the ENT key of the "Data Change" or "Keyboard" object is pressed. The flag does not turn ON when any other key is pressed.
 - While the touch key code is set to "000D" (Write to destination device: Execute), MO+5 turns ON in the same way when the touch key is pressed.
 - Once the completion flag turns ON, the ON status is held. In order to turn it OFF, execute the RST (RESET) instruction using the program in the PLC.
- #### 2) User ID
- The user ID is assigned to each "Number" and "Ascii" in the order of creation.
The user ID is assigned from "1" on each screen. When data is changed, the user ID is written to the control device DO+7.

Control device

- DO+7
"O" indicates the head control device No.
By checking the current value of DO+7, the user can know which "Number/Ascii" has been changed.
- There is no data changing flag.

When GT Designer is used

- 1) Completion flag
When a screen is created using the GT Designer, the system information (described in Section 6.6.2) write device DO+4 b2 turns ON as the completion flag.

System information

- DO+4 b2
"O" indicates the head write device No.

Operation

- When "Project Unit" in "Auxiliary Setting" in "Common Setting" in the screen creation software is set so that the key window is open, and the ENT key is pressed on the ten-key window, the flag turns ON.
- While the touch key code is set to "000D", the flag turns ON when the touch key is pressed.

2) User ID

The user ID can be assigned to each "Numerical Input" and "Ascii Input" using the screen creation software.

The programmer can set arbitrarily the user ID within the range of 1 to 165535. The user ID is written to the following device in the PLC.

System information

- DO+3
"O" indicates the head write device No.
By checking the current value of DO+3, the user can know which "Numerical Input/Ascii Input" has been changed.

3) Data changing flag

It is possible to notify the PLC that a numeric or ASCII is being changed. This makes it possible to forbid using numeric value or ASCII data as operation data for the PLC while data changing is being performed.

This function is available for the following versions or later.

Applicable version

GOT

Product model name	Version
F920GOT-K, F930GOT-K	From first product
F930GOT, F933GOT	V4.00 or later
F940GOT, F943GOT	V6.00 or later
F940WGOT	V1.00 or later

- System information b8 of write device D(O+4)
 O indicates the head write device No.
 * For the system information, refer to 6.6.2.

Example: When D20 is assigned.

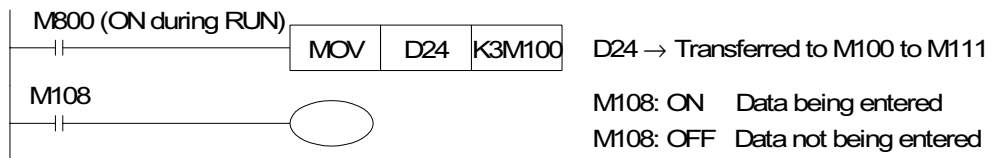

* "Data being entered" means that the cursor is on the displayed numeric value or ASCII input.

■Important point

Timing of data change for "Number" ("Numerical Input") and Ascii ("Ascii Input")

Data is changed in the PLC with the following timing.

When new data is entered and the ENT key is pressed, the new data is transferred to the PLC. When either the CLR key of a touch key or the ESC key of a key-pad is pressed before the ENT key, the new data is ignored and the existing data is kept registered.

MEMO

8. HPP Mode



CAUTION

- Read the manual thoroughly and confirm the safety sufficiently before changing the data or turning ON or OFF a bit device.
Otherwise, an erroneous operation may damage the machine or cause an accident.
- When connecting the GOT and a peripheral equipment for editing the ladder to one PLC using a function extension board for communication, do not edit a program or change a set value at the same time from the GOT and the peripheral unit.
Such a simultaneous operation may cause malfunction in the PLC.

In HPP mode, sequence programs (list format) can be edited, devices can be monitored, and set values and current values can be changed from the GOT to the connected PLC.

8.1 Outline of HPP mode

This section describes the operation procedure to change over to HPP mode and each function available.

◆ Basic operation

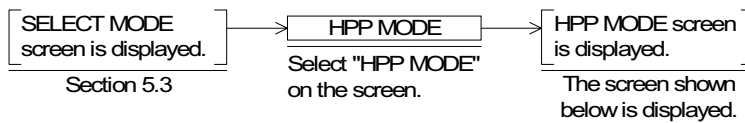

[HPP MODE MENU]

[HPP MODE]	END
PROGRAM LIST	a)
PARAMETER	b)
DEVICE MONITOR	c)
LIST MONITOR	d)
ACTIVE STATE MONITOR	e)
BFM MONITOR	f)
PC DIAGNOSIS	g)

- All of the following functions except c) are valid only when an FX Series PLC is connected.
- a) PROGRAM LIST (Section 8.2)
Sequence programs stored in the PLC can be edited in instruction list format.
 - b) PARAMETER (Section 8.3)
Parameters stored in the PLC can be edited.
 - c) DEVICE MONITOR (Section 8.4)
The ON/OFF status and the set value/current value of arbitrary devices in the PLC can be monitored. In addition, the ON/OFF status can be forced ON/OFF and the set values/current values can be changed.
 - d) LIST MONITOR (Section 8.5)
Sequence programs stored in the PLC are displayed, and the ON/OFF status of each instruction is displayed. (Current values of word devices cannot be displayed.)
 - e) ACTIVE STATE MONITOR (Section 8.6)
The reference Nos. of states (S) ON in the FX PLC are displayed.
 - f) BFM MONITOR (Section 8.7)
The contents of buffer memories in special blocks connected to an FX₂N/FX₂NC PLC can be displayed and changed.
 - g) PC DIAGNOSIS (Section 8.8)
Error information of the FX Series PLC is displayed.

8.2 PROGRAM LIST

When a MELSEC FX Series PLC manufactured by MITSUBISHI is connected, sequence programs stored in the PLC can be read/written/inserted/deleted in instruction list format. (Not available when using the F920GOT-K, F930GOT-K, F930GOT and F933GOT)

- Program list
 - Program all clear: All programs stored in the PLC are cleared.
 - Read: Devices can be read by specifying step Nos. or giving instruction words.
 - Write: Programs can be written. (While the PLC is running, programs cannot be written.)
 - Insertion: Programs can be inserted.
 - Deletion: Programs can be deleted by one instruction at a time.
- Program list monitor
Refer to Section 8.5.

- Outline of keyboard operations
The outline of keyboard operations are described below.

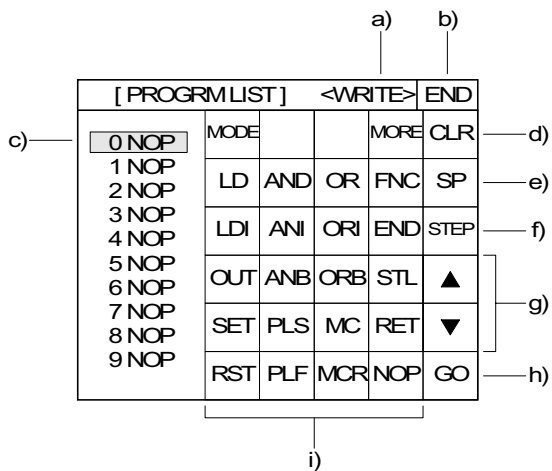

- a) Function display
The function (READ, WRITE, INSERT or DELETE) is displayed. Press the MODE key to change the function.
- b) END key
Terminates the program list and returns to the HPP MODE screen.
- c) Bar
Indicates the edit position (line).
- d) CLR key
Cancels the key currently being manipulated. This key does not delete instructions.
- e) SP key
Enters space.
Use this key to write a set value of a timer or counter or write an application instruction.
- f) STEP key
Displays the list from the entered step No.
- g) Cursor control keys
Move up and down the bar c) to change over the edit line.
- h) GO key
Determines the key operation.

i) Instruction/device keys

- Input of instruction

When the MORE key is pressed, instruction words are changed.

<Instruction word input keyboard>

MODE			MORE	CLR
LD	AND	OR	FNC	SP
LDI	ANI	ORI	END	STEP
OUT	ANB	ORB	STL	▲
SET	PLS	MC	RET	▼
RST	PLF	MCR	NOP	GO

← "MORE" →

MODE			MORE	CLR
MPS	MRD	MPP	P	SP
LDP	ANDP	ORP	I	STEP
LDF	ANDF	ORF	INV	▲
				▼
				GO

When an instruction word is entered, the device input keyboard is automatically displayed. The keyboard type is selected as shown below in accordance with the entered instruction word.

<Device input keyboard 1>

MODE				CLR
X	M	V	Z	SP
Y	S	K	H	STEP
T	C	P	I	▲
D				▼
				GO

<Application instruction input keyboard 1>

MODE				CLR
D	P			SP
				STEP
8	9			▲
4	5	6	7	▼
0	1	2	3	GO

<Device input keyboard 2>

MODE				CLR
		V	Z	SP
				STEP
8	9			▲
4	5	6	7	▼
0	1	2	3	GO

<Application instruction input keyboard 2>

MODE				CLR
X	M	V	Z	SP
Y	S			STEP
8	9			▲
4	5	6	7	▼
0	1	2	3	GO

◆ Basic operation

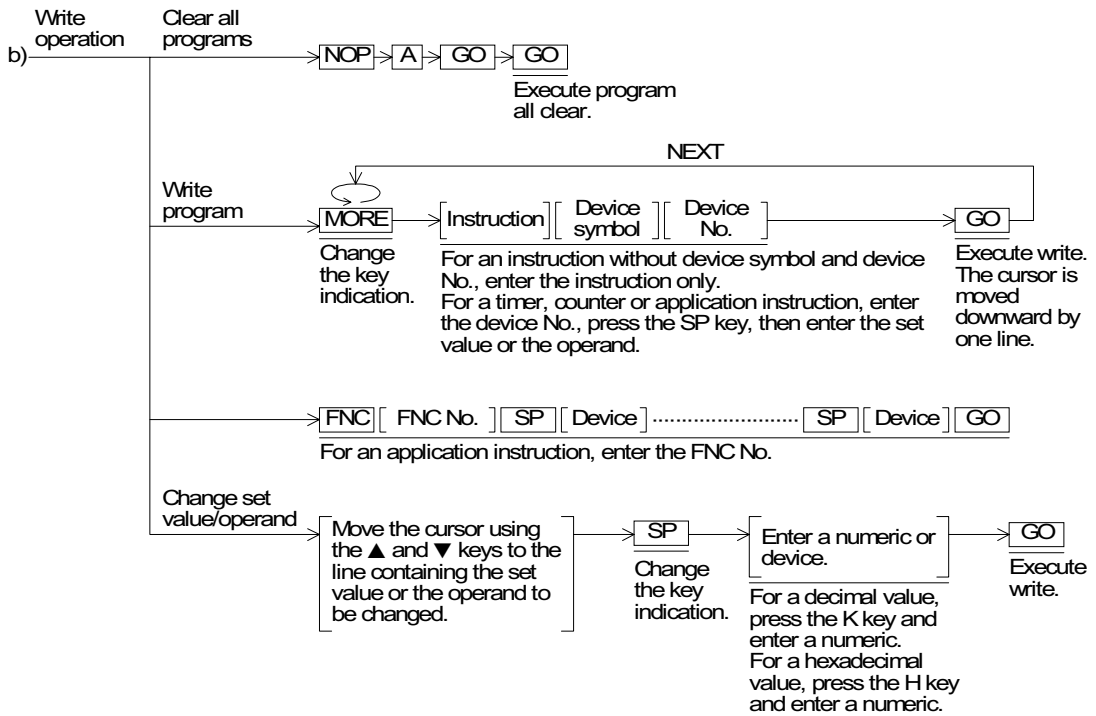
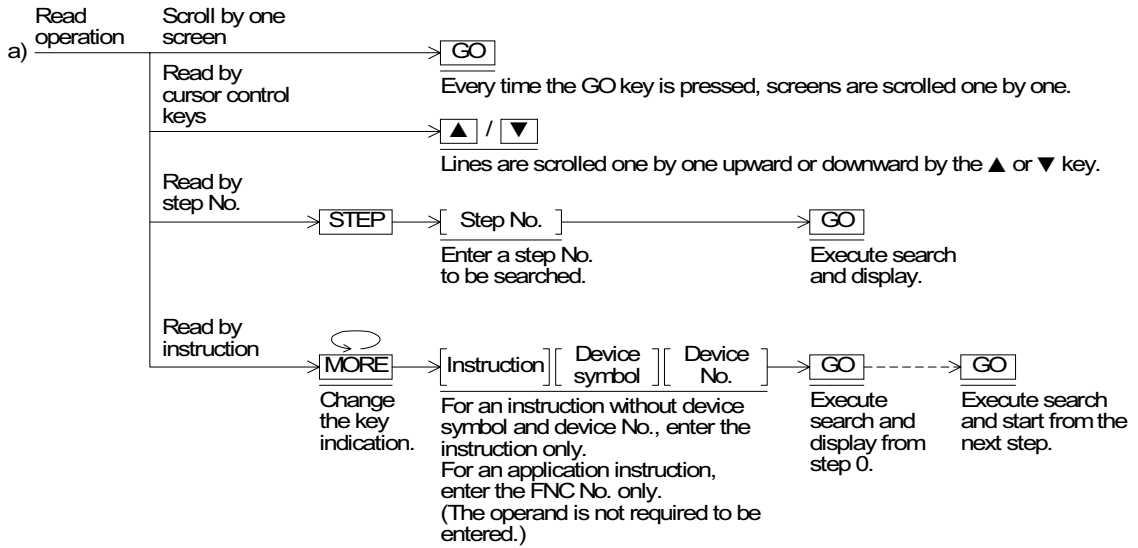
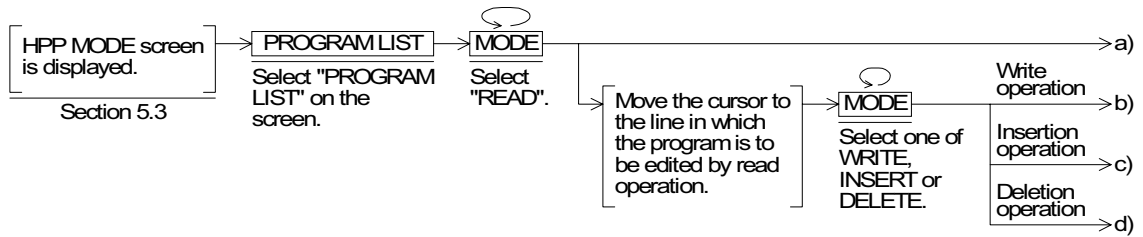

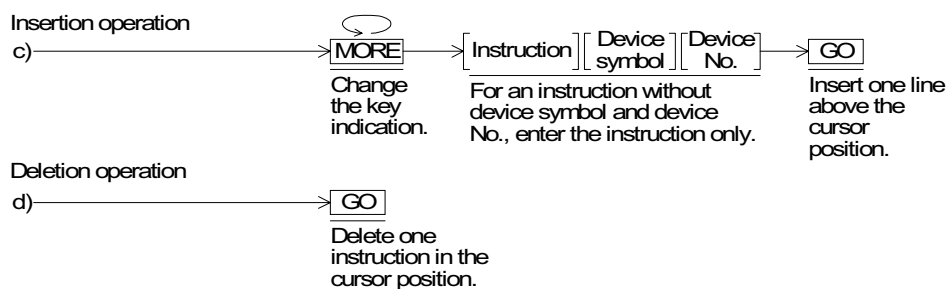

■ Important point

- 1) While an instruction, device symbol or device No. is entered, the input can be canceled by pressing the CLR key if the GO key has not been pressed.
An instruction determined by pressing of the GO key in the write or insertion operation can be changed (overwritten) by write of a program.
- 2) To create a new program, perform the write operation.
- 3) To enter an application instruction, enter the FNC No.
- 4) While the PLC is running, only the read operation can be performed.
When performing write, insertion or deletion of a program, stop the PLC.
- 5) Programs can be edited only while a RAM or EEPROM (whose write-protect switch is set to OFF) is used in the PLC.

Operation example 1 (read by a step No.)

Read operation of step No. 10

SCREEN

[PROGRAM LIST]	<READ>	END
0 LD X000		
1		
2		
3		
4		
5		
6		
7		
8		
9		

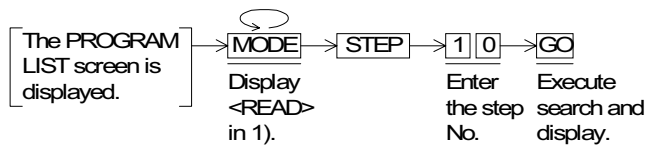

[PROGRAM LIST]	<READ>	END
10 LD X000		
11		
12		
13		
14		
15		
16		
17		
18		
19		

Operation example 2 (read by an instruction)

Read operation of OUT Y000

SCREEN

[PROGRAM LIST]	<READ>	END
0 LD X000		
1		
2		
3		
4		
5		
6		
7		
8		
9		

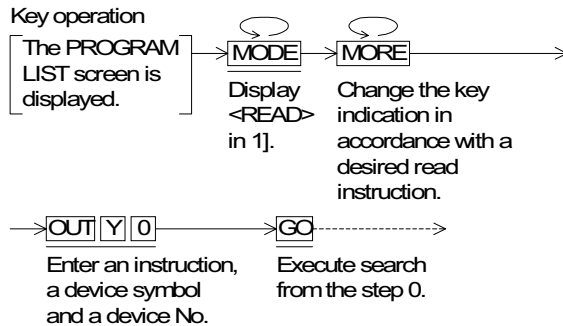

[PROGRAM LIST]	<READ>	END
20 OUT Y000		
21		
22		
23		
24		
25		
26		
27		
28		
29		

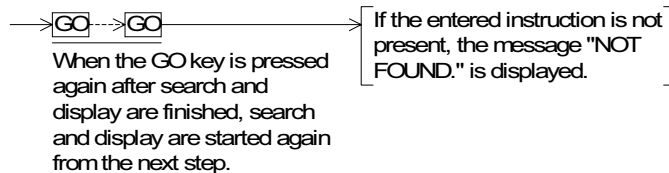

Important point

- 1) When there is an instruction occupying several steps entered in operation example 1, the head line of the instruction is search and displayed.
- 2) The read operation can be performed without regard to the memory type and the operation status (running or stop) of the PLC main body.

Operation example 3 (program all clear)

Program all clear operation

SCREEN

[PROGRAM LIST]		<WRITE>	END
0	LD X000		
1			
2			
3			
4			
5			
6			
7			
8			
9			

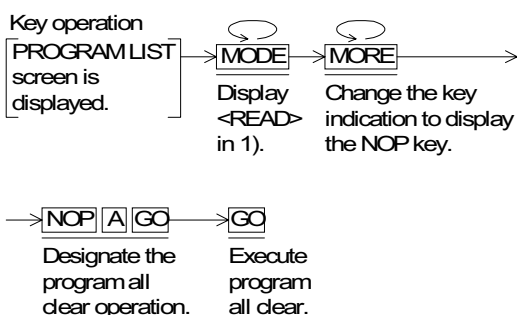

[PROGRAM LIST]		<WRITE>	END
0	NOP		
1	NOP		
2	NOP		
3	NOP		
4	NOP		
5	NOP		
6	NOP		
7	NOP		
8	NOP		
9	NOP		

■ Important point

- 1) Stop the PLC before performing the program all clear operation.
- 2) The all clear operation is enabled only when a RAM or EEPROM (whose write-protect switch is set to OFF) is used as the memory in the PLC.

Operation example 4 (write of a program)

Write operation for a program example shown below

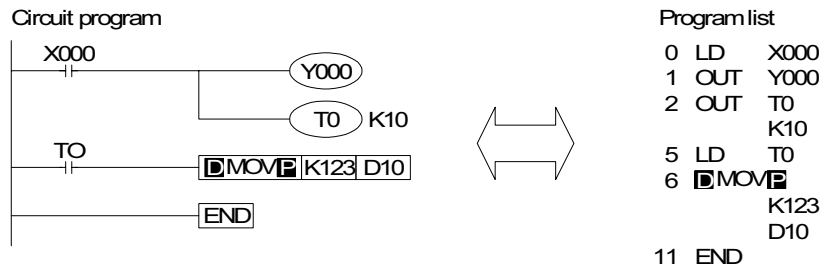

1)

SCREEN		[PROGRAM LIST]	<WRITE>	END
0	NOP			
1	NOP			
2	NOP			
3	NOP			
4	NOP			
5	NOP			
6	NOP			
7	NOP			
8	NOP			
9	NOP			

SCREEN		[PROGRAM LIST]	<WRITE>	END
0	LD	X000		
1	OUT	Y000		
2	OUT	T 0		
		K 0		
5	LD	T 0		
6	DMOV	12		
	K	123		
		D 10		
15	END			
16	NOP			

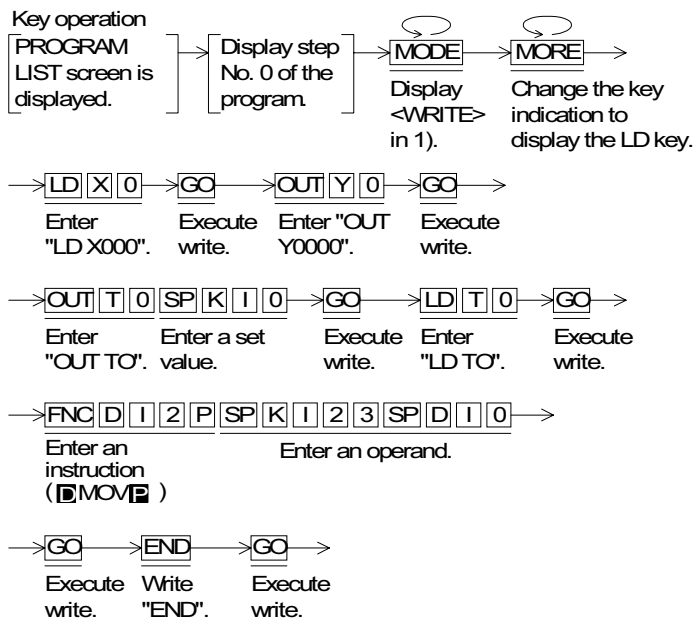

Important point

- 1) Stop the PLC before performing the program write operation.
- 2) The write operation is enabled only when a RAM or EEPROM (whose write-protect switch is set to OFF) is used as the memory in the PLC.
- 3) If there is a program in the PLC when a new program is written, the existing program is overwritten.

Operation example 5 (insertion of a program)
 Insertion of "LD X001"

SCREEN

[PROGRAM LIST] <INSERT> END			
0 LD X000			
1	⋮		
2			
3			
4			
5			
6			
7			
8			
9			

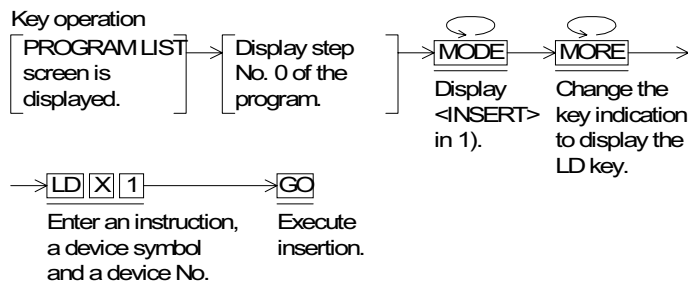

[PROGRAM LIST] <INSERT> END			
0 LD X001			
1 LD X000			
	⋮		

Operation example 6 (deletion of a program)
 Deletion of step No. 0

SCREEN

[PROGRAM LIST] <DELETE> END			
0 LD X001			
1 LD X000			
	⋮		

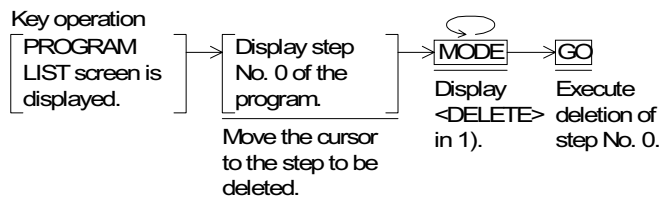

[PROGRAM LIST] <DELETE> END			
0 LD X000			
1	⋮		
2			
3			
4			
5			
6			
7			
8			
9			

Important point

- 1) The program insertion/deletion operation is enabled only while the PLC is stopped.
- 2) The program insertion/deletion operation is enabled only when a RAM or EEPROM (whose write-protect switch is set to OFF) is used as the memory in the PLC.
- 3) In operation example 5, an instruction is inserted above the cursor position. In operation example 6, an instruction in the cursor position is deleted.

8.3 PARAMETER

The parameters of a connected PLC can be displayed or changed. (Not available in the F920GOT-K, F930GOT-K, F930GOT and F933GOT)
 This function is only available for the FX Series PLC.

◆Basic operation

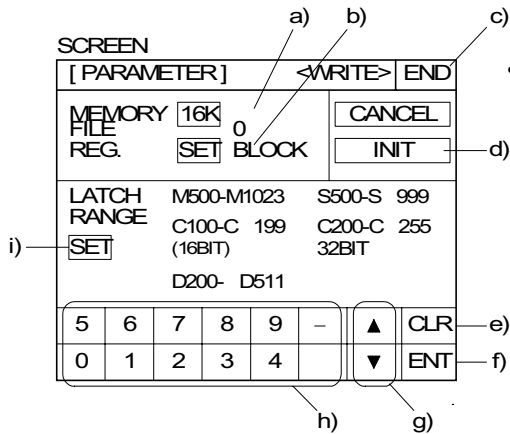
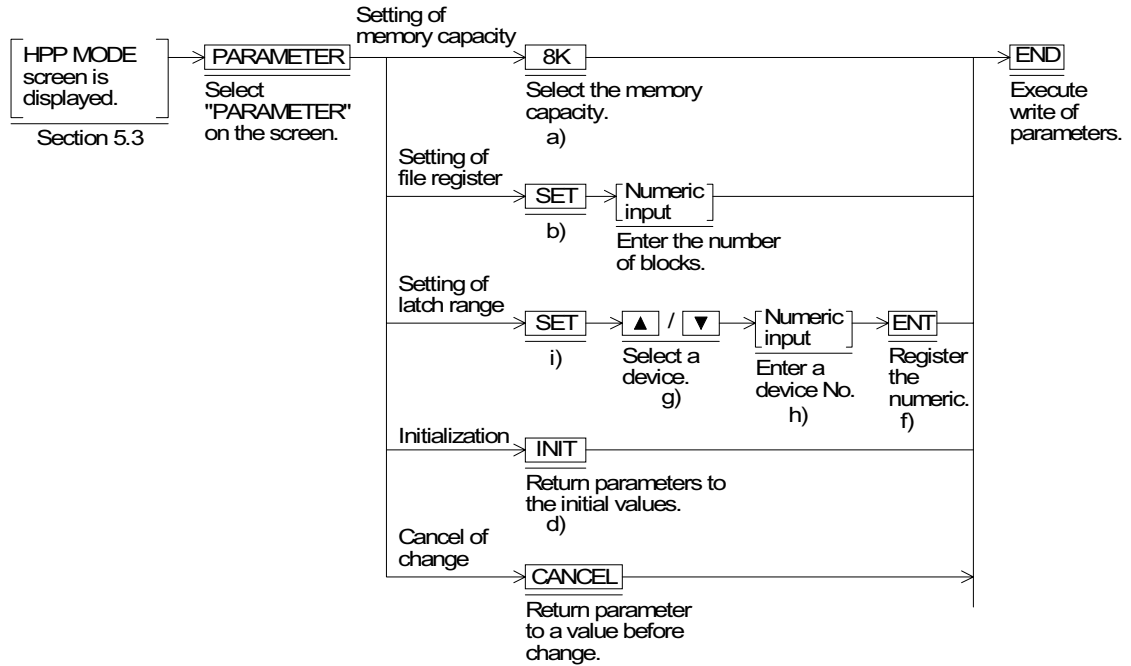

• This function is only valid for FX Series.

■Important point

- 1) In setting the memory capacity, the allowable setting range varies depending on the memory of the connected PLC main body (automatic recognition).
- 2) In setting the file register, the allowable setting range of the number of blocks varies depending on the selected memory capacity.
(One block occupies 500 steps. Up to 14 blocks are allowed when the memory capacity is set to 16 K steps.)
- 3) In setting the latch range, the allowable setting range of device No. varies depending on the connected PLC main body.
- 4) Change of each parameter is executed when the END key is pressed.
- 5) Change of parameters is enabled only while the PLC program is stopped.
- 6) Change of parameters is enabled only while a RAM or EEPROM (whose write-protect switch is set to OFF) is used as the memory in the PLC main body.
- 7) After entering a numeric, press the CLR key to cancel the entered value.

8.4 DEVICE MONITOR

The ON/OFF status and set value/current value of arbitrary devices in the PLC can be monitored. In addition, the ON/OFF status can be forced ON/OFF and the set values/current values can be changed.

[DEVICE MONITOR]				
[DEVICE MONITOR]				END
DEVICE	ON	OFF	▼	▲
SET	COMMENT	DEC/HEX		

- When "DEVICE MONITOR" is selected on the HPP MODE screen, the DEVICE MONITOR screen shown on the left is displayed.
(In the F920GOT-K, DEVICE MONITOR is displayed when HPP MODE is selected.)
Function keys are provided at the bottom of the screen. Each function key is actuated when touched.
(Touch keys are not displayed on the F920GOT-K.)
 - DEVICE : Allows to specify a device No. to be monitored.
 - ON/OFF : Turns ON/OFF the specified device.
 - SET : Executes change of the current value/set value.
 - COMMENT:Changes the monitor display.
- When using the F920GOT-K, operate the key-pad as follows:
 - Press the DEV key to start entering the device to monitor.
 - Press the ◀/▶ key to select a device symbol.
 - Press the 0 to 9 keys to enter device numbers, current and set value.
 - Press the ENT key to set the device monitor.
 - Press the ◀/▶ key to increase/decrease the displayed device monitor number.
 - Press the ESC key to cancel an input device or to exit DEVICE MONITOR.
 - Press the SET key while the arbitrary word device is being displayed to start changing the current/set value.
 - Press the 0 key while the arbitrary bit device, timer, or counter is being displayed to execute the forced OFF. Press 1 to execute the forced ON.

◆Basic operation

[Operation by touch key]

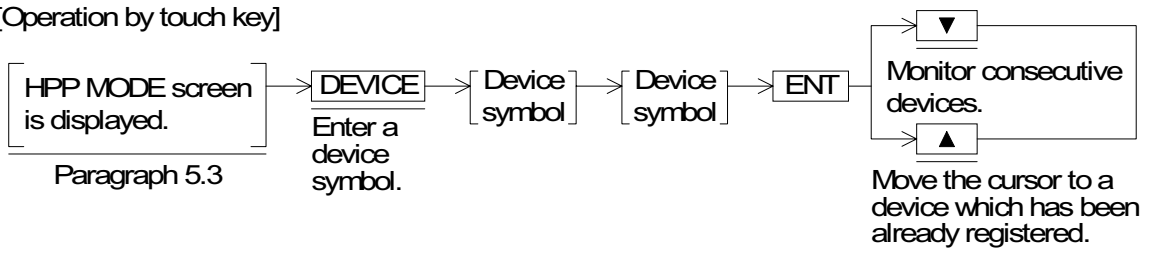

When the DEVICE key is pressed, the device symbol list is displayed.

X	Y	M	S	CLR
T	C	D16	D32	▲
Z	V			▼
				ENT

M 100				
C	D	E	F	CLR
8	9	A	B	▲
4	5	6	7	▼
0	1	2	3	ENT

[Operation in F920GOT-K]

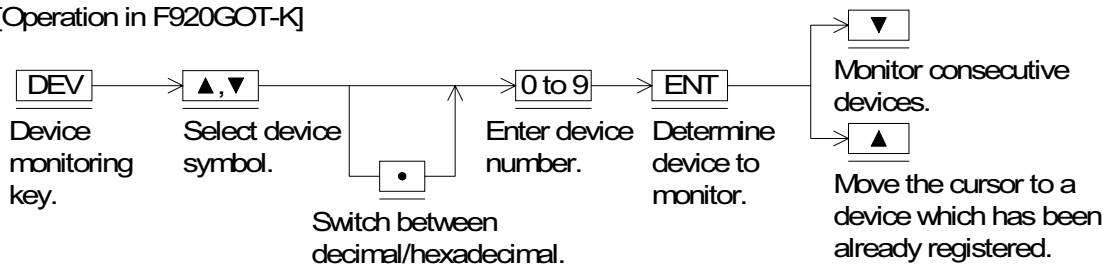

8.4.1 Device/comment monitor

Symbols such as X, Y comments can be displayed for monitoring. Comments can be created using the screen creation software FX-PCS-DU/WIN-E. (Available only in the F940GOT, F943GOT, and F940WGOT)

Operation example

Monitor the ON/OFF status of inputs X000 and X001, and the current value and set value of timer T3

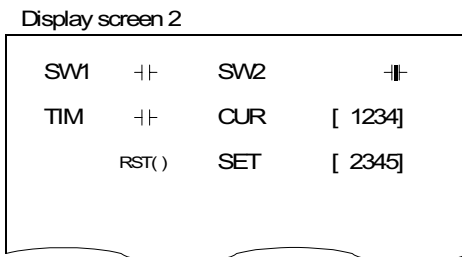
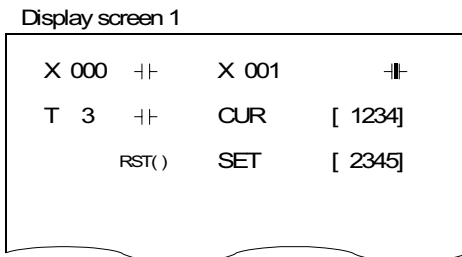

The ON/OFF status of each monitored device is indicated as follows.

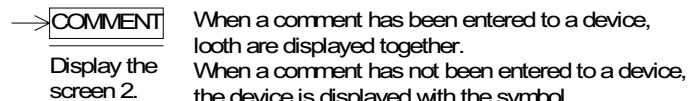
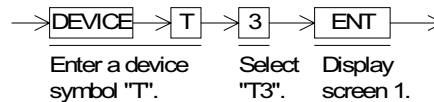
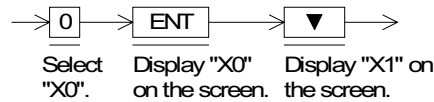
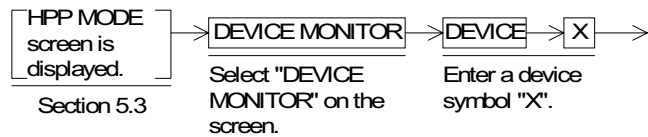
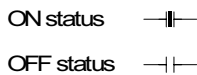

When a comment has been entered to a device, both are displayed together. When a comment has not been entered to a device, the device is displayed with the symbol. This comment display function is valid only when comments have been created using the screen creation software FX-PCS-DU/WIN-E.

Important point

1) Monitor function when timers and counters are indirectly specified

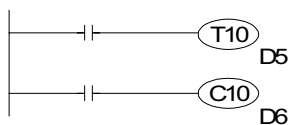

If a data register is used for the set value of a timer/counter as shown in the program on the left, the contents of the data register are used when monitoring is performed.

When the set value is changed (as described on the next page), the contents of the data register is overwritten.

8.4.2 Changing set values and current values of T, C and D

Set values and current values of word devices (T, C, D, V or Z) in the PLC can be changed.

◆Basic operation

[Operation by touch key]

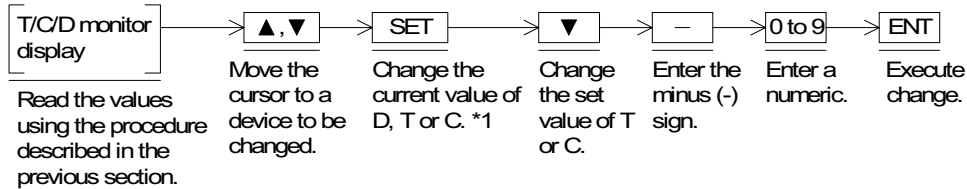

*1 When the SET key is pressed, the cursor is moved to a current or set value and the numeric input keyboard is displayed at the bottom of the screen.

Example: D0 [1000] ← Cursor

Numeric (decimal) input keyboard

5	6	7	8	9	-	▲	CLR
0	1	2	3	4		▼	ENT

[Operation in F920GOT-K]

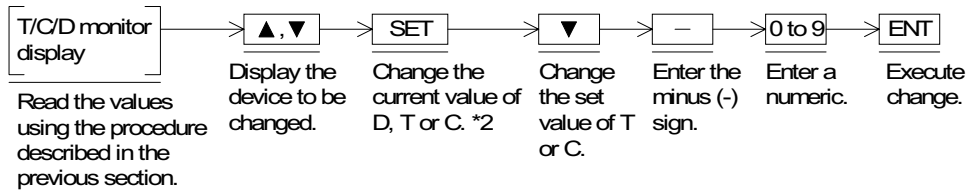

■Important point

1) Changing set values of T or C and file registers

They can be changed when RAM or EEPROM (FX0, FX0S, FX1S, FX0N, FX1N) is used as the memory for the PLC.

They cannot be changed when an EPROM or EEPROM cassette/board is used (FX0N, FX2N, FX2NC).

Operation example

Changing the current value of data register D0 from 300 to 200, the current value of T1 from 263 to 300 and the set value of T1 from 1000 to 1500 by operating a touch key (Excluding the F920GOT-K)

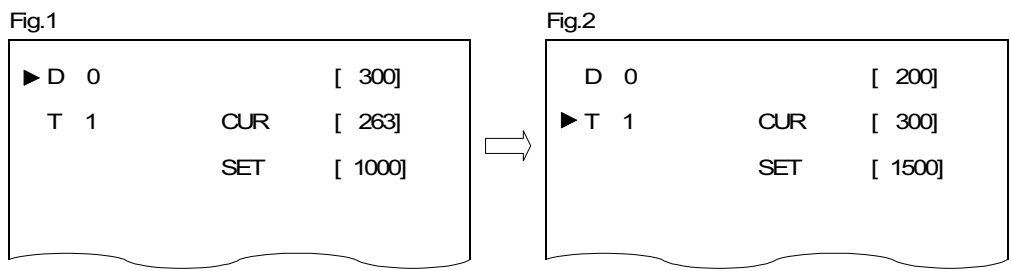
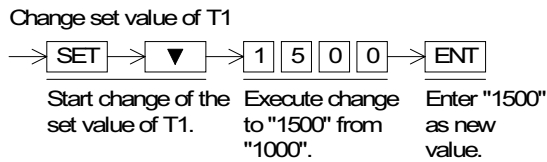
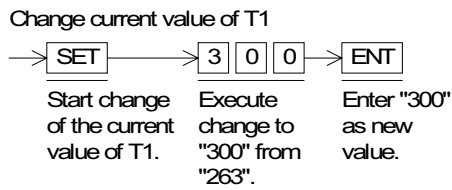
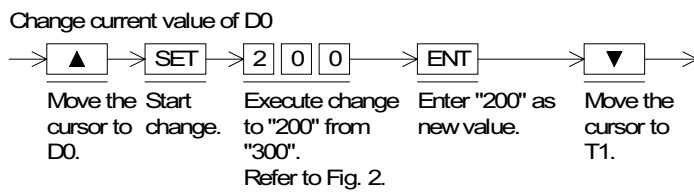
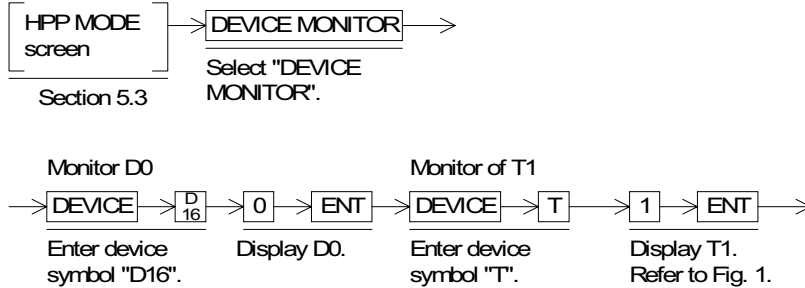

8.4.3 Forced ON/OFF

Bit devices (Y, M and S) and word devices (T and C) can be forced ON/OFF. When T, C, D, V or Z is forced OFF, its current value is reset to "0".

◆Basic operation

[Operation by touch key]

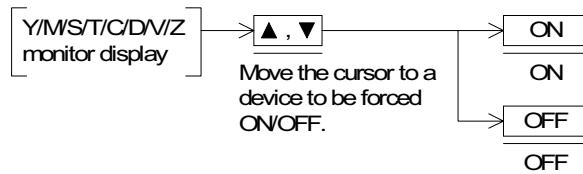

[Operation in F920GOT-K]

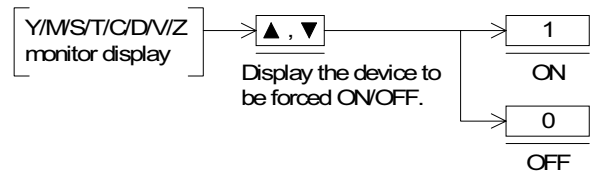

Operation example

Forced ON/OFF of output Y0 and auxiliary relay M0 by operating a touch key (Excluding the F920GOT-K)

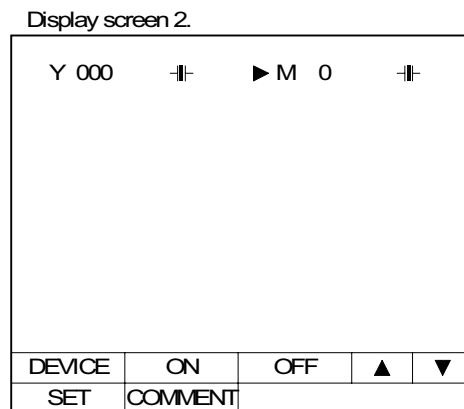
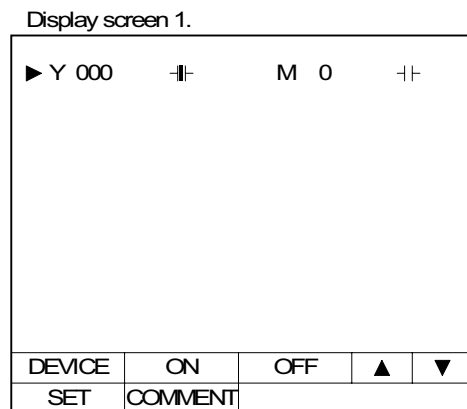
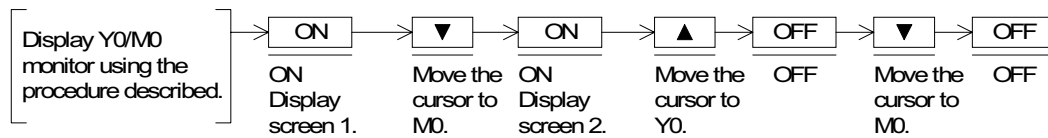

■Important point

- Caution on connecting the SYSMAC C Series manufactured by OMRON
 - Using a forced set/reset by peripheral equipment in the SYSMAC C Series PLC locks the PLC bit devices into their current state. This state cannot be changed by the PLC program. In the above described situation, using the USER SCREEN MODE or forced ON/OFF function in HPP MODE in the GOT will have the following consequences.
 - 1) If a bit device is turned ON/OFF in the GOT, all the bit devices are released to change state by the PLC program. (GOT uses the KC command)
 F930GOT or F933GOT: prior to Version 4.40; F940GOT or F943GOT: prior to Version 6.40; F940WGOT: prior to Version 1.40
 - 2) Only the device turned ON/OFF in the GOT is released to change state by the PLC program. (GOT uses the FK command)
 F930GOT or F933GOT: Version 4.40 or later; F930GOT-K: From first product, F940GOT or F943GOT: Version 6.40 or later; F940WGOT: Version 1.40 or later

8.5 LIST MONITOR

When a MELSEC FX Series PLC manufactured by MITSUBISHI is connected, PLC programs can be monitored in instruction list format. (Not available when using the F920GOT-K, F930GOT-K, F930GOT and F933GOT)

◆Basic operation

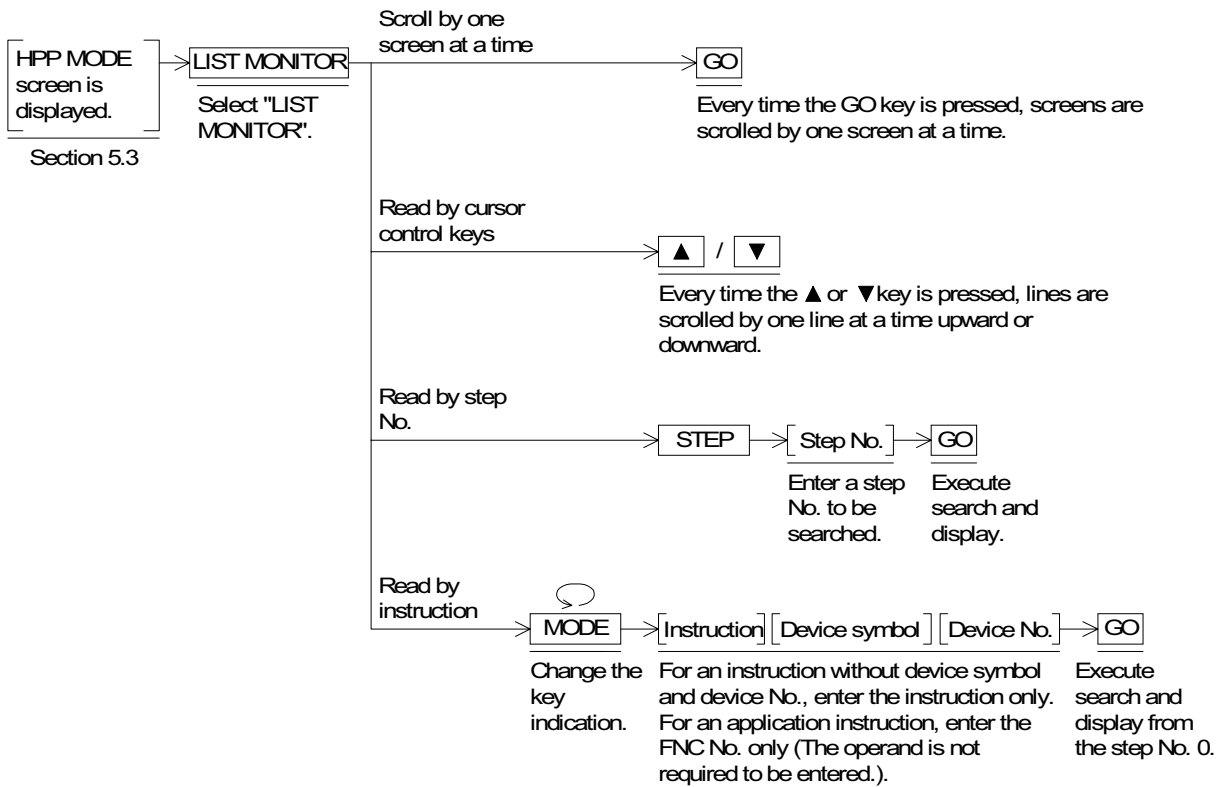

■Important point

- 1) List monitor can be performed without regard to the memory type and operation status (run or stop) of the PLC.

8.6 ACTIVE STATE MONITOR

Up to eight state Nos. in ON status can be monitored.

This function is valid in FX Series only. (Not available when using the F920GOT-K, F930GOT-K, F930GOT and F933GOT)

◆Basic operation

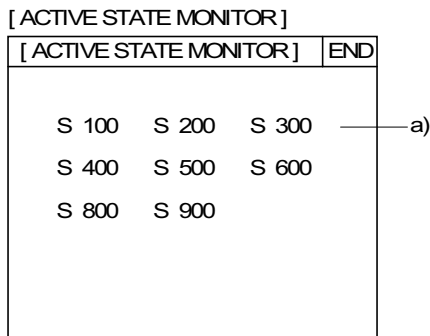
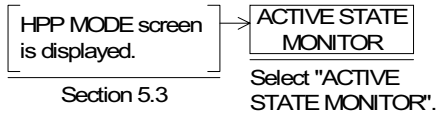

a) Active state
State Nos. in the ON status are displayed in the list.

- When there are no state Nos. in the ON status, the message "NO ACTIVE STATE" is displayed.
- When special auxiliary relay M8047 (step ladder monitor valid) is OFF in the sequence program, the message "M8047 IS NOT ON" is displayed.
- When there are more than 8 state Nos. in the ON status, all 8 Nos. are displayed from the smallest in ascending order. Excessive state Nos. are not displayed.

8.7 BFM MONITOR

The contents of buffer memories relating to special blocks connected to the FX_{2N}/FX_{2NC} PLC, can be read / written to.

The model of the connected special blocks are automatically recognized and the contents of the buffer memories are displayed together with the name and the unit. Accordingly, operations can be checked without performing any manual procedure. (Not available when using the F920GOT-K, F930GOT-K, F930GOT and F933GOT)

- Applicable special blocks
Analog input: FX_{2N}-4AD, FX_{2N}-4DA, FX_{2N}-4AD-PT, FX_{2N}-4AD-TC, FX_{2N}-8AD and FX_{2N}-2LC
High-speed counter: FX_{2N}-1HC
Pulse output: FX_{2N}-1PG
- FX_{2N}-8AD and FX_{2N}-2LC buffer memory data can be accessed when using the F940GOT, F943GOT Version 6.30 or later, or F940WGOT Version 1.30 or later.

◆Basic operation

- Serial block Nos. are assigned to special blocks connected to the FX_{2N}/FX_{2NC} Series basic unit. "0" is assigned to the special block nearest to the basic unit. Up to eight special blocks can be monitored and set.
For each available special block, its model name is displayed.
For each unavailable special unit (such as the FX-10GM and the FX-20GM), "UNKNOWN" is displayed.
When no special blocks are connected, "NONE" is displayed.
- When a special block to be monitored is selected, the buffer memory list is displayed as shown below.

[4DA]							(BLOCK 1)	END
OUTPUT MODE							(0mA to 20mA)	CH1
OUTPUT DATA							[0. 000](mA)	CH2
DATA HOLDING							HOLD	CH3
OFFSET DATA							[0. 000](mA)	CH4
GAIN DATA							[20. 000](mA)	INIT
GO ADJUST							FORBID	
ERR STATUS							UNDEFINED	
5	6	7	8	9	-	▲	CLR	
0	1	2	3	4		▼	ENT	

- The set value can be entered using the touch keys on the screen.
To enter a numeric, use the ten-key pad displayed at the bottom of the screen.
- The DETAIL key is provided for the FX_{2N}-1PG, etc. so that the contents of the buffer memories can be monitored in detail.

■Important point

- Setting of the buffer memories
The contents of the buffer memories set using this function are treated as follows when the power of the special block is turned off.
 - FX2N-4AD, FX2N-4DA, FX2N-4AD-PT, FX2N-4AD-TC, FX2N-8AD and FX2N-2LC
The setting contents are saved in the built-in EEPROM, and kept stored even if the power is turned off.
In the FX2N-2LC, however, the setting contents are saved when the EEPROM write button is pressed.
In the FX2N-8AD, buffer memory such as average frequency and addition data is not saved when a power failure occurs.
For the details, refer to the special function block's user's manual.
 - FX2N-1HC and FX2N-1PG
The setting contents are saved in the built-in RAM, therefore deleted when the power is turned off.

When the buffer memories have been set using a PLC program (TO instruction), the PLC program has priority.

Use the buffer memory monitor function to perform initial setting of special blocks and monitor buffer memories.

9. Sampling MODE

This chapter describes the sampling mode in which the contents of continually changing data registers are acquired at a constant time interval (in a constant cycle) or, in the ON/OFF condition (trigger) of bit devices.

The acquired data can be displayed in graph or list format.

The acquired data can be printed in the 'Other mode' of the GOT or using the user screen creation software. The sampling mode can be used to manage data on the operation rate of machines and the production status.

F920GOT-K, F930GOT-K, F930GOT and F933GOT has no sampling mode.

9.1 Outline of sampling mode

The contents of the specified 4 data registers (16 bits) are acquired in a constant cycle or by a trigger condition. The data in up to 2,000 registers can be acquired in a constant cycle, by the trigger condition.

◆Basic operation

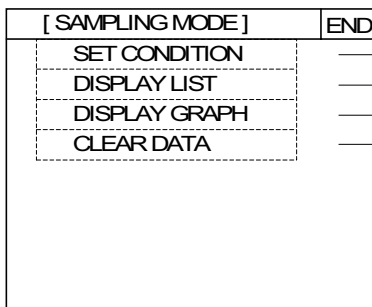
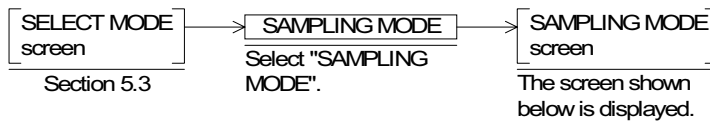

- When "SAMPLING MODE" is selected, the screen shown on the left is displayed. On this screen, the sampling condition can be set, the results displayed, and the acquired data cleared.

- a) SET CONDITION (Section 9.2)
Data registers to be sampled, the sampling timing (trigger or constant cycle), the sampling start and end times can be set.
- b) DISPLAY LIST (Section 9.3)
The sampling time (hour, minute and second) and sampling result are displayed in the form of list.
- c) DISPLAY GRAPH (Section 9.3)
The sampling result is displayed in the form of trend graph.
- d) CLEAR DATA (Section 9.4)
All of the data acquired by sampling is cleared.

- Data acquired by sampling can also be used in the following ways.
 - In screen mode (in which user screens are displayed), the system screens for the condition setting and result display of the sampling mode can be displayed.
 - In "PRINT OUT" on the OTHER MODE screen, the sampling data can be printed out. When the sampling data is read using the screen creation software, the sampling data can be output to a printer connected to a general-purpose computer.
 - Sampling data can be saved to FDs and the HD using the screen creation software.
 - Saved sampling data can be converted into the text format (.txt) using the screen creation software FX-PCS-DU/WIN-E. In this way, the sampling data can be processed using commercial software.

■Important point

- 1) The registered sampling condition and the acquired sampling data are backed up by the battery. Even when the power of the GOT is turned off, the setting contents are stored.
- 2) If a function shown below is selected while sampling is performed, the task may be paused or aborted and the sampling data may be cleared. The sampling data can be cleared by setting a control bit device to ON or selecting "CLEAR DATA" on the SAMPLING MODE screen. (Refer to Section 9.4.)

Mode	Function	Sampling	Sampling data
Other mode	Current time	Sampling is paused while the time is set. (Sampling is continued when the time is displayed but not set.)	The data acquired until sampling is paused, is saved. When time setting is finished, the data starts to be acquired again.
	Transfer to PC *1 Read/collation	Sampling is continued.	The sampling data is saved even while data is being read and collated.
	Transfer to PC *1 Write	Sampling is aborted.	The data acquired until sampling aborted, is saved.

*1 Communication with the screen creation software such as transfer of user screen data

- 3) The sampling condition related to time is managed by "SET TIME SWITCH" in "SET-UP MODE". Accordingly, when performing sampling related to time, make sure that the time is correct, then start sampling.

9.2 Outline of sampling condition setting

The sampling condition should be set before starting.
 This section describes the outline of the sequence and contents of setting.
 For the operating procedures, refer to the next page and later.

◆Basic operation

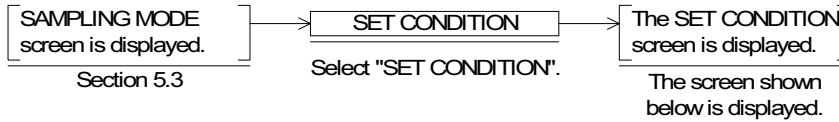

- On the SET CONDITION screen, "SAMPLE COND.", "START COND.", "END COND." and "SAMPLING DEV." can be set. Each item functions as a touch key. When a desired item is touched, the corresponding setting screen is displayed.

[SET CONDITION]		END
SAMPLE COND.	DEVICE M0 OFF→ON	a)
START COND.	DEVICE M0 OFF→ON	b)
END COND.	NUMBER 0	c)
SAMPLING DEV.	D100	d)

a)SAMPLE COND. (Section 9.2.1)

- Set the sampling condition. When the condition set here is satisfied, data on a specified data register is acquired.
 The sampling condition can be set to "DEVICE" or "CYCLIC".
 DEVICE : Data is acquired when a bit of X, Y, M, S, T or C turns ON (OFF → ON) or OFF (ON → OFF).
 CYCLIC : Data is acquired at a constant time interval.

b)START COND. (Section 9.2.2)

- Set the timing to start sampling.
 DEVICE : Sampling is started when a bit of X, Y, M, S, T or C turns ON (OFF→ ON) or OFF (ON → OFF).
 TIME : Sampling starts at a specified date and time (date, hour, minute and second).
 The time set in "SET TIME SWITCH" in "OTHER MODE" is used as the reference.
- If the start condition set here is not satisfied, sampling is not performed even if the sampling condition is satisfied.
 * When the start condition has not been set, specify M8000 (FX Series) or M9036 (A Series) which is always ON while the PLC is running.

c) END COND. (Section 9.2.3)

- Set the timing at which sampling is finishes.
 NUMBER : Sampling is finished when data collection has been performed the specified number of times.
 Trigger (DEVICE): 2,000 times maximum
 Constant cycle (CYCLIC): 2,000 times maximum
 DEVICE : Sampling is finished when a specified bit device becomes ON or OFF.
 TIME : Sampling is finished at the specified date and time (date, hour, minute and second). If the end time is not reached even after sampling has been performed more than 2,000 times, the data acquired so far is deleted from the oldest one and the newest data is saved.

a) SAMPLING DEV. (Section 9.2.4)

- Specify a data register (16 bits) whose data is to be acquired.
 Only one device can be specified here. Then, data on four registers, D (specified one), D+1, D+2 and D+3, will be acquired.
- The set condition is backed up by the battery and saved, even if the power of the GOT is turned off or another mode is selected.

■Important point

- Mechanism and responsibility of sampling
 Sampling is performed in the following way.

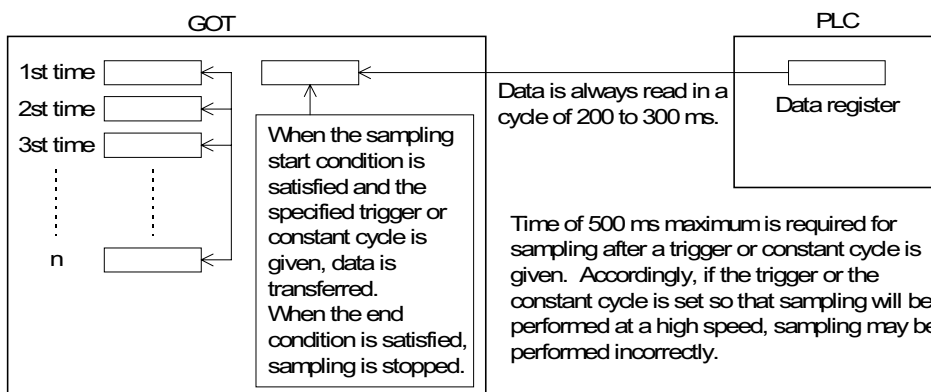



* It is recommended to take the sampling time of 1 second or more both for a trigger and a constant cycle.

9.2.1 SAMPLE COND.

Set the timing at which sampling is performed. When the sampling condition set here is satisfied, a specified data register is accessed and its data is stored. The sampling condition, trigger (DEVICE) or constant cycle (CYCLIC) can be selected.

- Sampling by trigger

When X, Y, M, S, T or C becomes ON (OFF → ON)  or OFF (ON → OFF) , sampling is performed. (D, Z and V cannot be specified.)

- Sampling in constant cycle

A cycle (time interval) can be set within the range of 1 second to 10 days, 23 hours, 59 minutes and 59 seconds. Sampling is performed at the specified time interval.

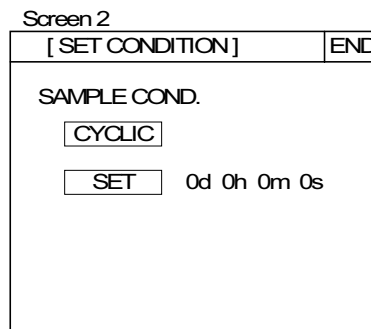
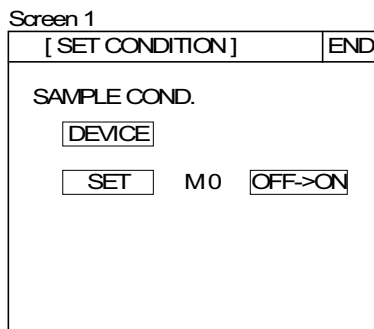
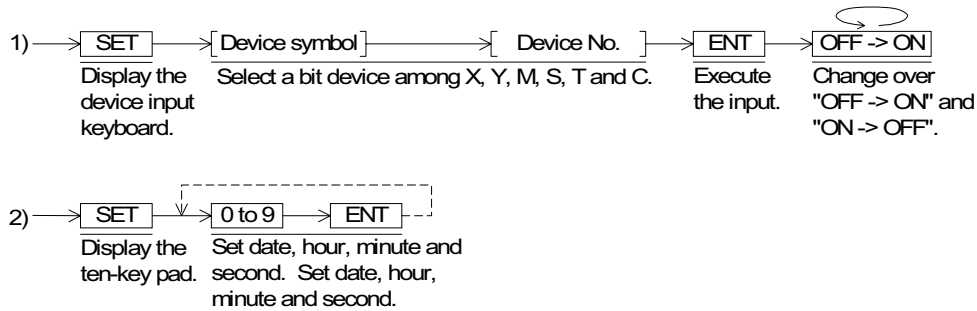
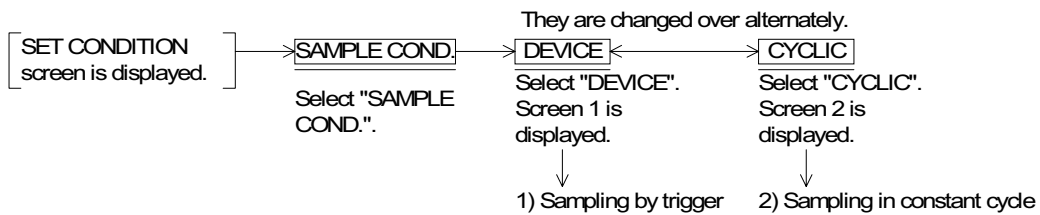

◆Basic operation



9.2.2 START COND.

Set the timing at which sampling is started. (Even if the sampling condition (trigger or constant cycle) is satisfied, sampling is not performed if the start condition is not satisfied.)

- Sampling start by trigger

When X, Y, M, S, T or C becomes ON (OFF → ON)  or OFF (ON → OFF) , sampling is started. (D, Z and V cannot be specified.)

- Sampling start by time

The time can be set within the range of 1 second to 31 days, 23 hours, 59 minutes and 59 seconds. When the specified time has come, sampling is started.

◆ Basic operation

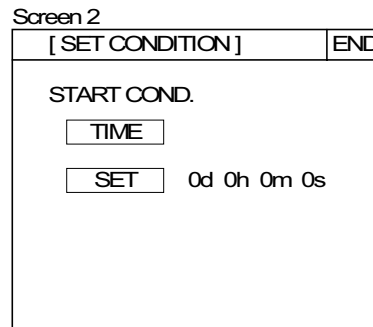
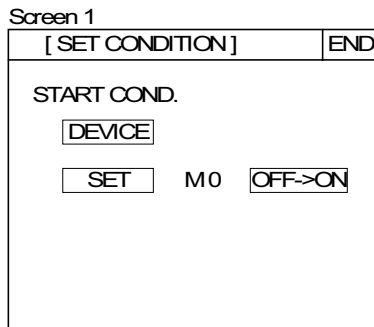
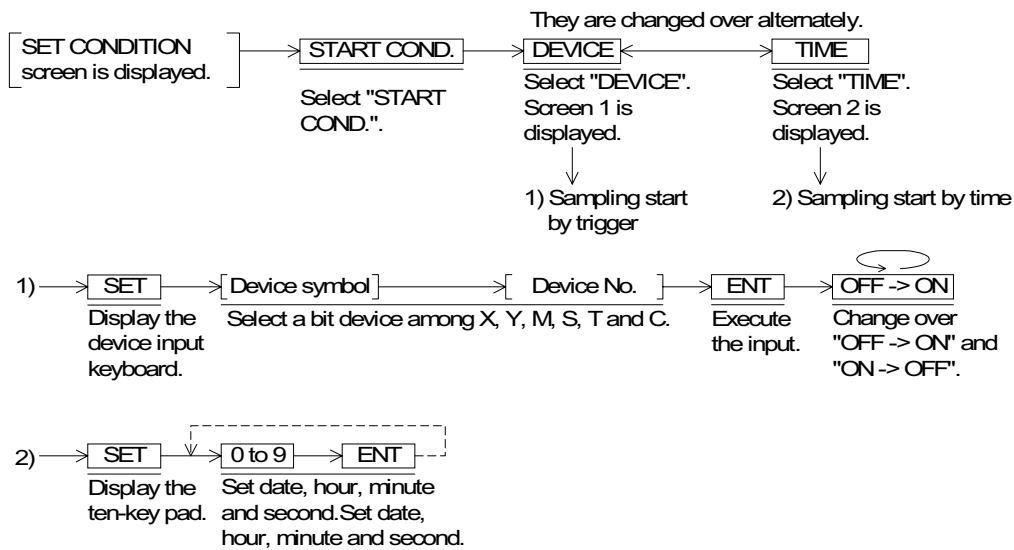

9.2.3 END COND.

Set the timing at which sampling finishes. When the end condition is satisfied, sampling finishes.

- Sampling end by occurrence
Sampling is finished after the specified number of times (2,000 times maximum).
- Sampling end by time
Sampling is continued until the specified time. However, when data on more than 2,000 times has been acquired, the data acquired so far is deleted, oldest first and new data is saved (that is, the sampling data is shifted).
- Sampling end by trigger
Sampling is finished when the specified device No. becomes ON or OFF. However, when data on more than 2,000 times has been acquired, the data acquired so far is deleted oldest first and new data is saved.

◆Basic operation

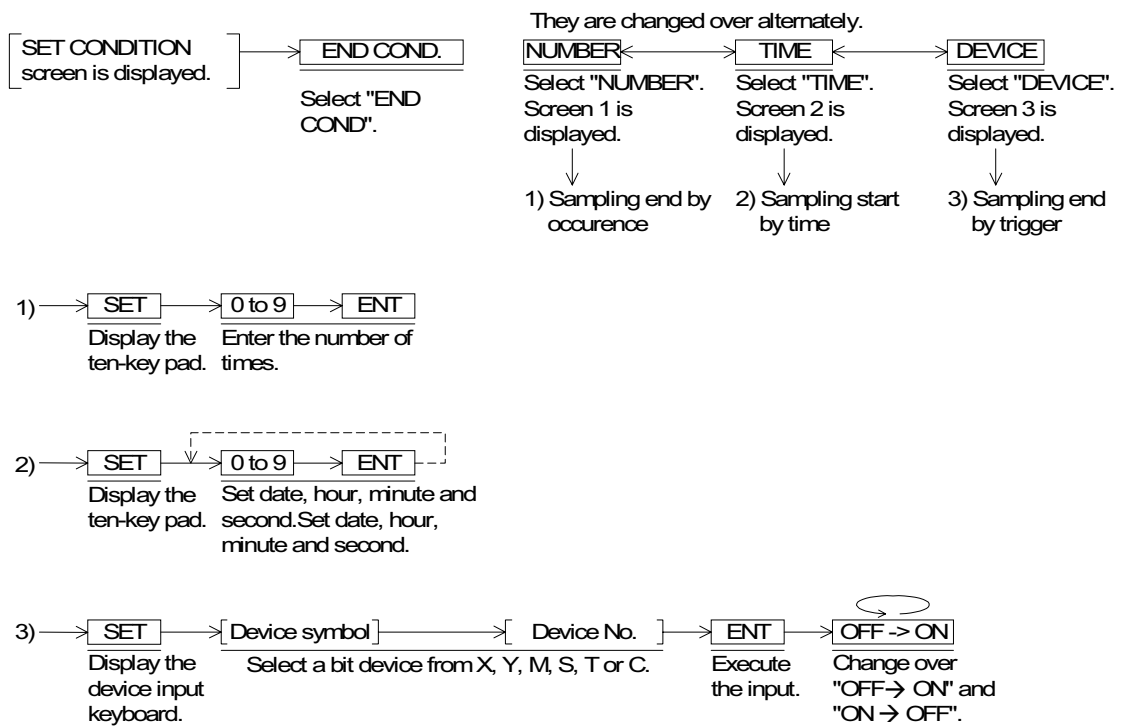

Screen 1

[SET CONDITION]	END
END COND.	
[NUMBER]	
[SET]	0 TIMES

Screen 2

[SET CONDITION]	END
END COND.	
[TIME]	
[SET]	0d 0h 0m 0s

Screen 3

[SET CONDITION]	END
END COND.	
[DEVICE]	
[SET]	M0 [OFF -> ON]

9.2.4 SAMPLING DEV.

Set a data register to be treated as the sampling target address. Only one data register can be specified. Data will be acquired from four consecutive data registers beginning with the one set here.

◆Basic operation

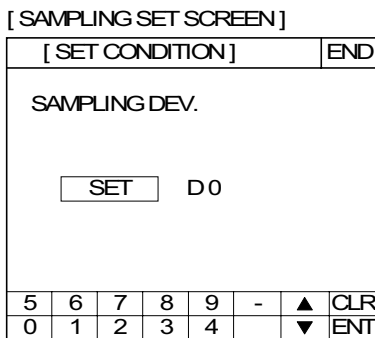
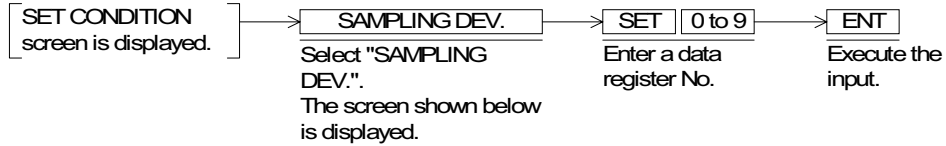

- 16 bit word devices (D, T, C) other than the data register can be specified from V1.10 of F940WGOT and V2.00 of F940GOT and F943GOT. (There is no sampling mode in F920GOT-K, F930GOT-K, F930GOT and F933GOT)

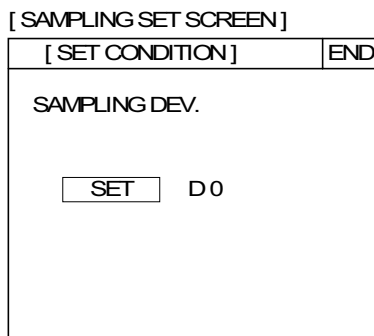
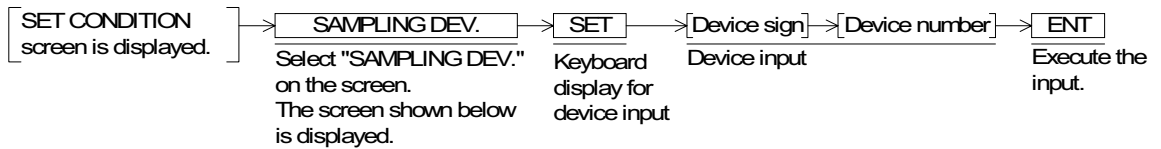

9.3 Display of sampling result

The sampling result can be displayed in the form of a list or trend graph.

9.3.1 DISPLAY LIST

The sampling result is displayed in the form of list. Four sets of data are displayed on each screen.

◆Basic operation

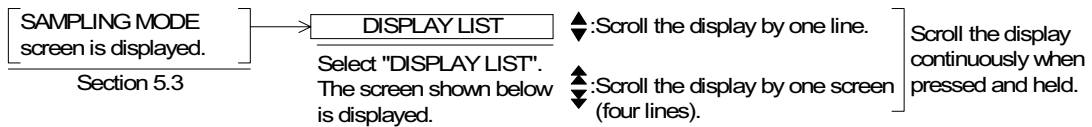

[DISPLAY LIST]			END
a)	NUMBER	TIME	▲
	1	13:00:00 0 0	▲
		0 0	
	2	13:01:00 0 0	
		0 0	
	3	13:02:00 0 0	▼
		0 0	
	4	13:03:00 0 0	▼
		0 0	

- a) NUMBER (Sample number)
- b) TIME (time when sampling was performed)
- c) Sampling result
The result is displayed in the following order.
DO DO+1
DO+2 DO+3
("O" indicates a data register No. specified in "SAMPLING DEV.")

9.3.2 DISPLAY GRAPH

The sampling result is displayed in the form of trend graph.

◆Basic operation

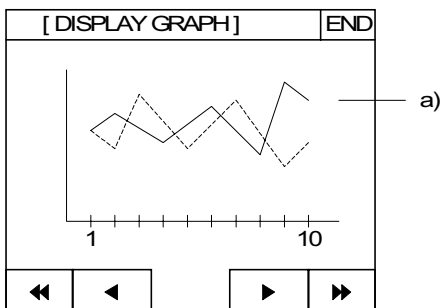
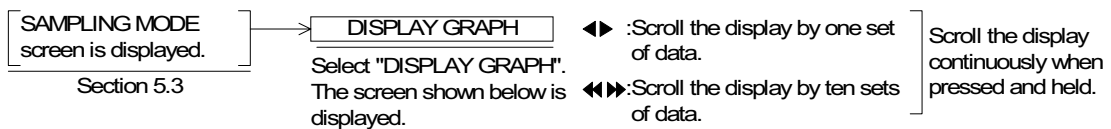

- a) Sampling result
DO DO+1
DO+2 DO+3
("O" indicates a data register No. specified in "SAMPLING DEV.")
In "DISPLAY GRAPH", values within the range of -32,768 to +32,767 are displayed in trend graphs.

9.4 CLEAR DATA

All of the data acquired by sampling can be cleared.

◆Basic operation

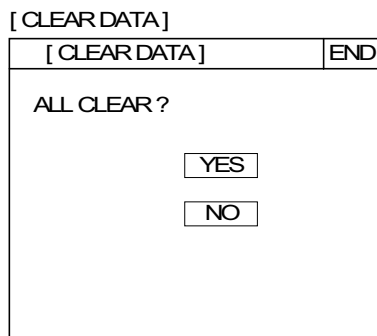
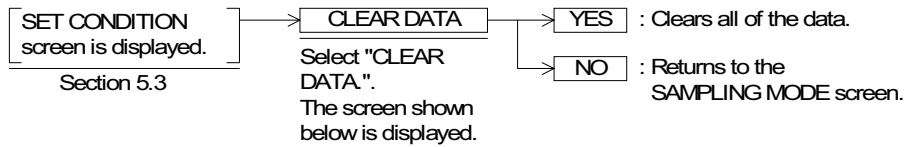

■Important point

- "CLEAR DATA" clears only the sampling data. The data set on the SET CONDITION screen is not cleared.
- When the message "COMPLETED!" is displayed, the sampling data is cleared.
- When "CLEAR DATA" is executed while sampling is being performed, all of the acquired data is cleared and sampling is stopped.

9.5 Control signals in PLC

The sampling data can be cleared and the sampling status can be monitored from the PLC without manipulating the GOT.

9.5.1 When FX-PCS-DU/WIN-E is used

- In the sampling mode, M3 and M4 are used.

Example: When the head control device No. is set to M0

M3: Clears the sampling data. (It is used as a coil.)

M4: Remains ON while sampling is performed. (It is used as a contact.)

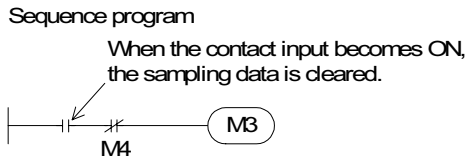

When M3 becomes ON during sampling, sampling is aborted and the acquired data is cleared. It is recommended to provide a b contact of M4 for interlock so that the acquired data is not cleared during sampling.

9.5.2 When GT Designer

- Word devices are occupied for communication between the GOT and the PLC. (Refer to Section 6.6.2.)
- Read devices and write devices are set for communication, and the following devices are used in the sampling mode.

Read device : When the third bit (b2) of the specified word device becomes ON, the sampling data is cleared.

Write device : The second bit (b1) of the fifth word device from specified word device (which is regarded as the first word device) remains ON while sampling is performed.

Example: When D10 is assigned as a read device and D20 as a write device

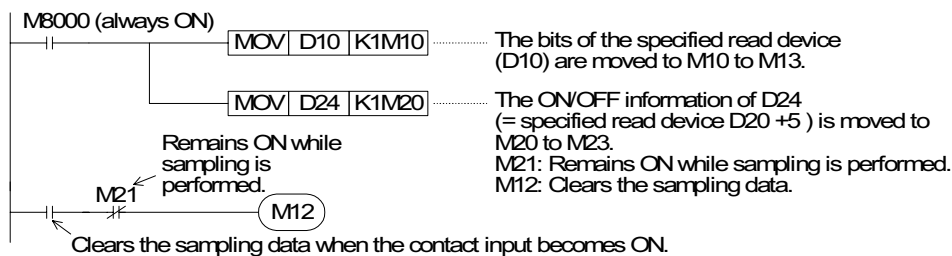

10. Alarm MODE

This chapter describes the alarm function in the GOT which monitors up to 256 consecutive bit devices and displays alarm messages created by the user on screen or, displays a specified screen when a monitored bit devices turns ON.

By using the alarm function, alarm messages and a list of current alarms can be displayed, the alarm history can be stored, machine status monitored, and troubleshooting facilitated.

10.1 Outline of alarm function

The GOT monitors up to 256 consecutive bit devices (X, Y, M, S, T and C) in the PLC which have been preliminarily specified as alarm devices.

Alarm devices can be assigned and alarm messages (comments) created using the screen creation software.

- When the FX-PCS-DU/WIN-E is used
Alarm devices : Can be set in "Alarms" in "View".
Alarm messages : Can be created in "Alarms" in "View".
- When the GT Designer is used
Alarm devices : Can be created in "Alarm History" in "Common Setting".
Alarm messages : Can be created in "Comment" in "Draw".

When an alarm device set by the screen creation software above turns ON from OFF, a corresponding alarm message can be displayed and output to a printer in USER SCREEN MODE (screen created by the user) and ALARM MODE (system screen).

- In the F920GOT-K, F930GOT-K, F930GOT, and F933GOT, ALARM MODE is unavailable as a system screen. "Alarm list" and "Alarm history" can be displayed in USER SCREEN MODE (screen created by the user).
In the F920GOT-K, up to 32 successive device numbers can be specified as alarm devices.

10.2 Alarm function in screen mode

When an alarm has occurred, the alarm can be indicated by an operation shown in the table below.

The indication method varies depending on the screen creation software used.

In the F920GOT-K, 'upper, medium and lower' setting is invalid.

- In the screen mode (while a user screen is displayed)

Notification method	FX-PCS-DU/WIN-E		GT Designer
Window display (comment window display)	✓	Either one can be selected.	✓ ^{*1}
Screen changeover (changeover of base screen)	✓		✓ ^{*1}
Flow display	✗		✓
Printing	✓		✓ ^{*2}

*1 Displayed when the DETAIL key is pressed on the system screen. (As for the F920GOT-K, refer to Section 10.2.2.)

*2 The alarm data cannot be printed while using GT Designer or F920GOT-K. Print out the alarm data after reading it out to a personal computer using the screen creation software.

- In the case of mono-chrome display GOT units, characters in each object of the alarm history display and alarm list display are displayed in black (characters in the cursor line are displayed in white).

This means that only one line in which the cursor is located is legible if the screen color is black.

When using these objects, the background color should be white.

(The initial screen color in GT Designer is black.)

10.2.1 Set item

1) Window display (comment window display)

- In FX-PCS-DU/WIN-E
If "window display" is selected as the alarm notification method, when an alarm device turns ON, an alarm message corresponding to that device is displayed on the user screen.
- Using the screen creation software, alarm messages can be created and alarm display positions can be selected from upper, medium and lower.
In the F920GOT-K, the 'upper, medium and lower' setting is invalid.

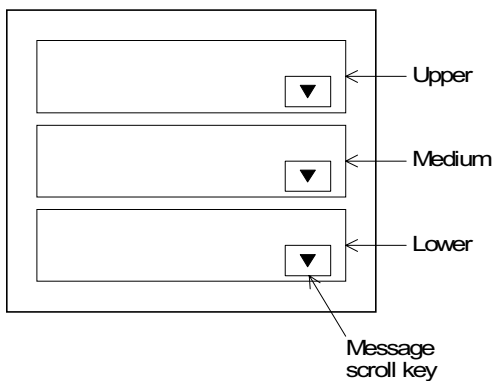

- An alarm message can be displayed in up to 20 characters.
- When two or more alarm devices have turned ON, the alarm messages can be scrolled using the message scroll keys. (As for the F920GOT-K, refer to Section 10.2.2.)
When two or more errors have occurred in the system, the error messages are displayed in the same way.
When alarm devices have turned OFF, the window is closed.
- This window is displayed in screen mode (while a user screen is displayed).
When the display is changed to a system screen (alarm mode), the window disappears. However, if an alarm device is ON, the window is displayed again when the display is changed to a user screen again.
- In GT Designer
By setting "Detail Display Destination" in "Basic Setting" in "Alarm History Common Setting" in the software to "Comment Window", detailed comment messages corresponding to alarm devices can be displayed.
In this case, the object "Alarm History" or "Alarm List" is displayed on the user screen, and detailed comment messages are displayed when a key whose key code has been set to "FFB8 (detail display)" is pressed. (As for the F920GOT-K, refer to Section 10.2.2.)
Alarm history display : Refer to Section 21.6.2.
Alarm list display : Refer to Section 21.6.3.

2) Screen changeover (changeover of base screen)

If "screen changeover" is selected, when a specified alarm device turns ON from OFF, a user screen displayed at that time in the screen mode is changed over to a specified screen. When the GT Designer is used, a specified screen is displayed when the DETAIL key or ► key (in the F920GOT-K) is pressed.

The display can be returned from the specified screen to the previous screen using the following procedure.

(When the GT Designer is used, a specified screens are displayed when the DETAIL key or the ► key is pressed.)

- In the case of the FX-PCS-DU/WIN-E
Set "Destination Screen" to "DU memory" in the "Change Screen" object of the changed screen.
- In the case of the GT Designer
Set "Next screen" to "Previous" in "Base switching Screen" of the changed screen.

3) Printing (Setting is available only in the FX-PCS-DU/WIN-E.)

When an alarm has occurred, the date of occurrence and a corresponding alarm message can be printed.

Alarm messages should have been entered in half-width characters. The communication condition of the printer should have been set in "SERIAL PORT" in "SET-UP MODE" in the GOT. (Cannot be printed when using the F920GOT-K)

4) Flow display (FX-PCS-DU/WIN-E: V2.41 or later, GT Designer: SW1D5C-GOTR-PACKE or later)

When an alarm device turns ON, a corresponding alarm message is displayed at the bottom of the user screen.

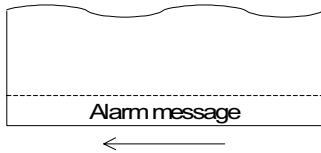

- A message scrolls from the right to the left.
- If two or more alarms occur, corresponding alarm messages are displayed in the ascending order of the alarm device No.
- When an alarm device turns OFF, the displayed alarm message disappears.
- Alarm messages are displayed transparently on the user screen so that the keys on the user screen are valid.

- In the case of FX-PCS-DU/WIN-E
The Moving Alarm can be set Report in the setting window in "View/Project" – "Alarms" in FX-PCS-DU/WIN-E.
The notification method is limited to one of, screen changeover, window display and flow display described above.
- In the case of GT-Designer
Set by editing "Common Setting" – "Auxiliary Setting" – "Screen" in the screen creation software whether or not the flow display is to be performed. (In the initial value, the flow display is effective.)

10.2.2 Operation in F920GOT-K

- In the F920GOT-K, alarms can be displayed in "Alarm List" and "Alarm History" in "USER SCREEN MODE".
At this time, scroll or delete displayed alarms using the key pad.
The following contents are assigned to the keys on the key pad.
 - "–" key : Displays or deletes the cursor. (Every time the "–" key is pressed, the cursor is shown or hidden alternately.)
 - "▲" key : Moves the cursor upward.
 - "▼" key : Moves the cursor downward.
 - "▶" key : Displays the details.
 - "9" key : Resets the specified device [valid only for the alarm history display].
(When setting the alarm history in the screen creation software, make the reset function valid.)
- The above operations are unavailable while the displayed numerical or ASCII data is being changed (or cursor is being displayed).
Perform the above operations after pressing the ESC key to clear the cursor display.

10.2.3 Alarm history clear using key code

In the case of the following versions or later of the GOT and screen creation software, it is possible to assign a key code to a touch key and clear the alarm history.
(A key code cannot be assigned to a switch on the key-pad in the F920GOT-K and F930GOT-K.)

Applicable version

GOT

Product model name	Version
F930GOT, F933GOT	V2.00 or later
F930GOT-K	From first product
F940GOT, F943GOT	V3.00 or later
F940WGOT	V1.00 or later

Screen creation software

Software name	Applicable version
GT Designer	SW2D5C-GOTR-PACKE(A) or later
FX-PCS-DU/WIN-E	V2.30 or later

By pressing a touch key assigned the following key code on a screen displaying the alarm history display function, the alarm history can be cleared.

Key code	Function
FFB6(H)	If the alarm selected with the cursor is solved, its history is cleared.
FFB7(H)	All the solved alarms are cleared regardless of the cursor position.

Display example

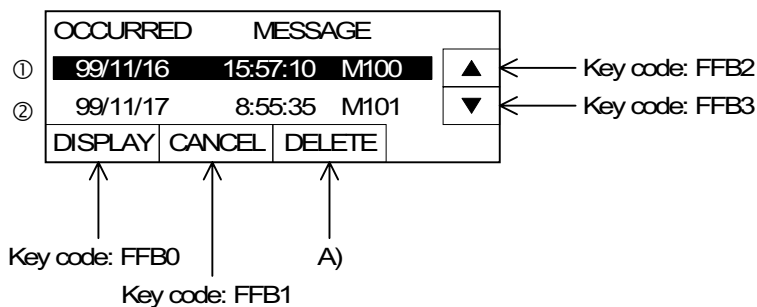

When key code FFB6 is assigned to A) :

Deletes alarm ① where the cursor is located from the screen display if it has already recovered.

Does not delete alarm ① from the screen display if it has not been recovered.

When key code FFB7 is assigned to A) :

Deletes all alarms which occurred in the past and have already recovered from the screen display.

10.3 Alarm function in alarm mode

In alarm mode, the alarm function described below is offered. (Not available in the F920GOT-K, F930GOT-K, F930GOT and F933GOT)

◆Basic operation

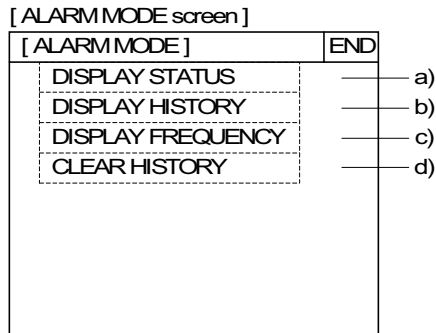
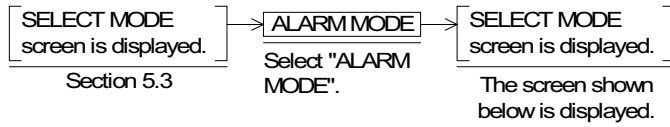

- a) DISPLAY STATUS
Displays the list of messages corresponding to alarm devices which are ON currently. Alarm devices in the ON status can be reset from the GOT.
- b) DISPLAY HISTORY
Stores and displays alarm occurrence date/time and alarm messages in the order of occurrence. Up to 1,000 alarms can be stored.
- c) DISPLAY FREQUENCY
Stores the number of each alarm device turns ON, and displays the frequency in the order of alarm device No. Up to 32,767 cases can be stored.
- d) CLEAR HISTORY
Clears all of the alarm history and the alarm frequency.

The system screens a) to d) (Nos. 1008 to 1011) can be displayed also in the screen mode.

10.3.1 Operation when alarms have occurred

The figure below shows the outline of operation performed when alarms have occurred. When a bit device assigned as an alarm device turns ON (OFF → ON), the GOT recognizes that an alarm has occurred.

When two or more alarms have occurred, the GOT recognizes them one by one in turn.

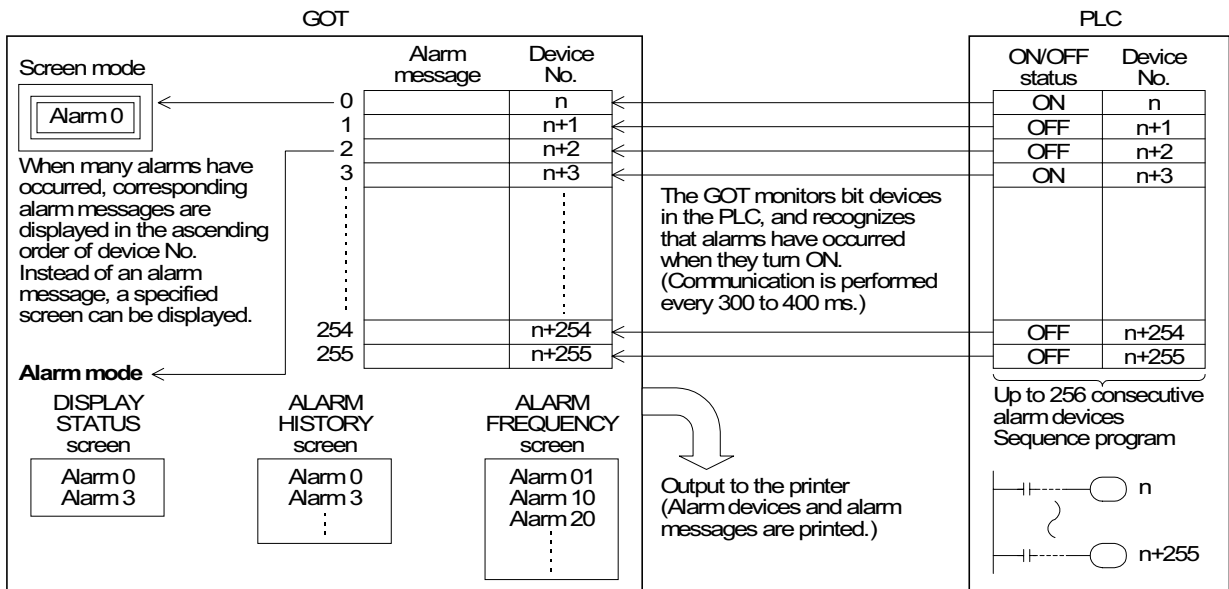

- The ON/OFF status of alarm devices are read every time communication is performed (every 300 to 400 ms) between the GOT and the PLC when FX-PCS-DU/WIN-E is used or at the time interval (variable within the range of 600 to 100 ms) set by "Monitor Cycle" in "Alarm History Common Setting" when GT Designer is used. When using the F920GOT-K, the monitor interval greatly changes according to the processing situation (such as the alarm or observe status function). The pulse change may not be caught if there are many tasks and the pulse interval of the target bit devices is short. In order to catch the pulse change, make sure to maintain the ON/OFF status of the bit device for a sufficient length of time.
- Inside the GOT, alarm messages are displayed (overlying on the user screens) or a specified screen is displayed in the screen mode, alarm devices are stored in the history and their frequencies are counted in the alarm mode in accordance with the contents set preliminarily in the screen creation software.
- When two or more alarms have occurred, they are sorted in the ascending order of alarm device No. in the alarm list and stored in alarm history in the order of occurrence. When GT Designer is used, the alarm history can be stored in the order of occurrence (from the oldest one) or in the reverse order of occurrence (from the latest one).

- In alarm history and alarm frequency, up to the following number of cases can be stored respectively. They are stored even if the power is turned OFF.

Alarm history : Up to 1,000 cases

If 1,001 or more alarms have occurred, the record is updated while excessive alarms are deleted from the oldest one. (When GT Designer is used, it can be set so that excessive alarms are deleted from the latest one.)

Alarm frequency: Up to 32,767 cases

If more alarms have occurred, 32,767 cases remain stored.

- If an alarm has occurred in any mode other than the screen mode, the occurrence history and frequency are recorded. The display can be changed to a specified screen, and the alarm can be output to a printer. (However, the alarm message does not overlay the base screen displayed at that time.)

10.3.2 Alarm list

This section describes the operating procedure to display the alarm list. In alarm status, devices with ON status are displayed together with corresponding alarm messages. Alarms can be confirmed (using the ACK key) and alarm devices reset. The alarm list is displayed in ascending order of alarm device No.

◆Basic operation

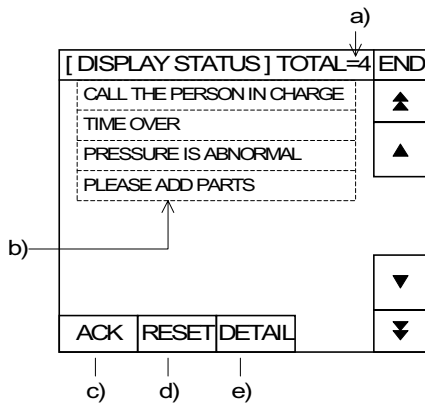
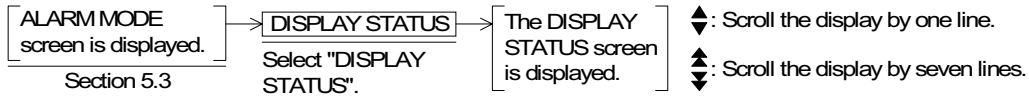

a) Number of alarm devices ON

b) Alarm message

- When FX-PCS-DU/WIN-E is used, comments created in "Alarms" are displayed.
- When GT Designer is used, comments which are created in "Comment Edit" and specified by "Comment No." in "Alarm History Common Setting" – "Monitor Device" are displayed.

c) ACK key

d) RESET key

e) DETAIL key to display a detailed message

- The ACK, RESET and DETAIL keys can be set using the screen creation software.

	FX-PCS-DU/WIN-E	GT Designer
ACK key	✓	✗
RESET key	✓	✓
DETAIL key	✗	✓

1) Confirmation operation (valid when FX-PCS-DU/WIN-E is used)

The operator can perform this operation to confirm that alarms have occurred. Place the cursor on an alarm to be confirmed using the scroll keys, and press the ACK key c).

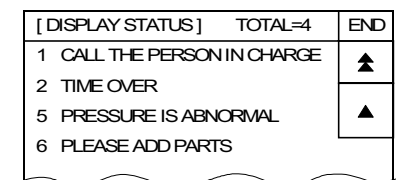

If the alarm device is OFF when the ACK key is pressed, the corresponding alarm message is deleted from the alarm list and alarm messages after that are shifted upward.

If the alarm device is ON when the ACK key is pressed, the corresponding message remains displayed.

To reset (set to OFF) an alarm message, perform the reset operation described overleaf.

2) Reset operation

An occurred alarm (auxiliary relay in the ON status) can be reset to OFF. Place the cursor on an alarm to be reset using the scroll keys, and press the RESET key 4). When the alarm device (auxiliary relay) is reset, the corresponding alarm message is deleted from the list.

However, when the RESET key is set together with the ACK key, the corresponding alarm message in the list is not deleted even if the alarm device is set to OFF. In such a case, perform the confirmation operation described above.

In the sequence program shown below in which an auxiliary relay turns ON again even if it is set to OFF once by the reset operation, the alarm device cannot be reset to OFF.

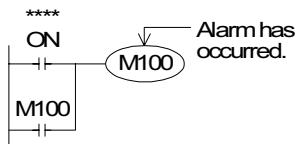

For example, if M100 is reset to OFF, M100 will turn ON again if the contact **** is ON.

Change the program so that the contact **** which causes the alarm device M100 to turn ON is set to OFF.

* To make the reset operation effective, make sure to set the reset function effective in alarm setting in the screen creation software.

3) Detail display (valid when GT Designer is used)

The alarm message list (comment window) or the base screen can be changed to the detailed display.

To enable detailed display, "Detail Display Destination" in "Alarm History Common Setting" in the screen creation software should be set to "Comment Window" or "Base Screen".

- When "Comment Window" is selected

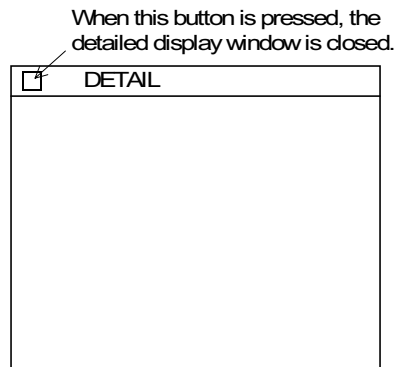

- Place the cursor on an alarm message, and press the DETAIL key. Then, the detailed display window is open as shown on the left.

- Comments which are created in "Comment Creation" and specified by "Comment No." in "Alarm History Common Setting" – "Device Monitor" – "Edit" are displayed.

* When FX-PCS-DU/WIN-E is used, comments in the alarm list are displayed.

- When "Base Screen" is selected
The specified screen in "Detail Display No." in "Alarm History Common Setting" – "Device Monitor" – "Edit" is displayed.

10.3.3 Alarm history display

This section describes the operating procedure to display the alarm history. In the alarm history, alarm devices which have turned ON so far are displayed together with the date of occurrence and corresponding alarm messages in the order of occurrence. Up to 1,000 cases can be stored in the alarm history. When more alarms have occurred, excessive alarm history data is deleted from the oldest one, and the latest data is stored. (The alarm history is displayed from the oldest alarm.) The order of display (from the oldest alarm or from the latest alarm) can be specified. The alarm history can be deleted using the procedure described in "10.3.5 Alarm history clear".

◆Basic operation

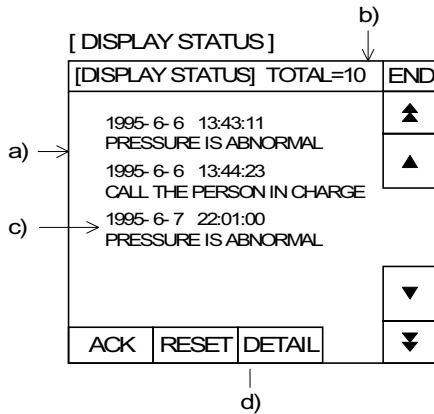

- a) Five alarms in the order of occurrence
- b) Total number of alarms stored in the history
- c) Date of alarm and corresponding alarm message
- d) DETAIL key to display alarm message details

* The ACK key is provided so that the operator can confirm that alarms have occurred. The RESET key resets occurred alarms (auxiliary relays in the ON status) to OFF. Even if the RESET key is pressed, corresponding alarms are not deleted from the history. For the DETAIL key, refer to "(3) Detail display" in the previous section.

10.3.4 Alarm frequency display

This section describes the operating procedure to display the alarm frequency.
 The frequency (number of occurrences) of each alarm is displayed in the ascending order of alarm device No.
 Up to 32,767 cases can be stored.

◆Basic operation

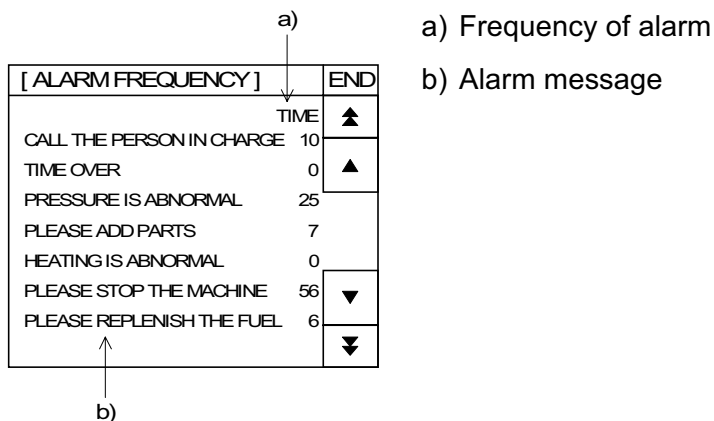
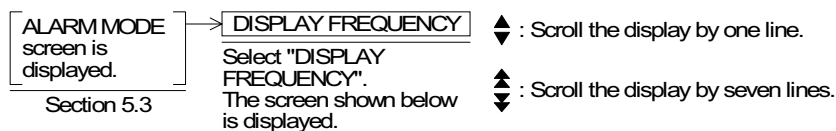

10.3.5 Alarm history clear

This section describes the operating procedure to clear the alarm history. The clear history function deletes both the alarm history and the alarm frequency result.

◆ Basic operation

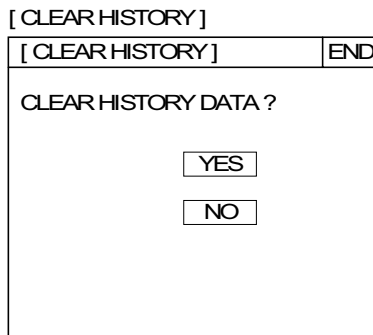
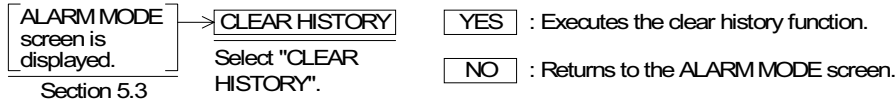

- When the message "COMPLETED!" is displayed, the history has been cleared.
- By setting a control device (system information) to ON, the alarm history can be cleared from the PLC.

When FX-PCS-DU/WIN-E is used

When the first bit (b0) of a control device turns ON, the alarm history is cleared.

Example: When M0 is selected as the control device

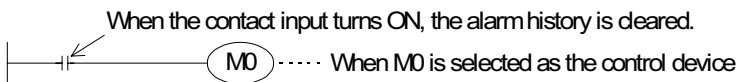

When GT Designer is used

When the first bit (b0) of the head read device (word device) turns ON, the alarm history is cleared.

Example: When D10 is selected as the head read device

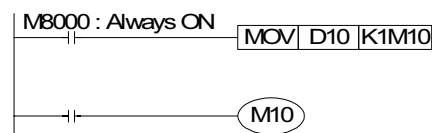

By using a device specified in "History Clear Trigger" – "Alarm History Common Setting" in the screen creation software, alarm history can be cleared in the same way.

MEMO

11. Test MODE

This chapter describes the test mode in which the user screen list can be displayed, data files can be edited, and debugging can be performed to confirm key operations.

11.1 Outline of test mode

◆Basic operation

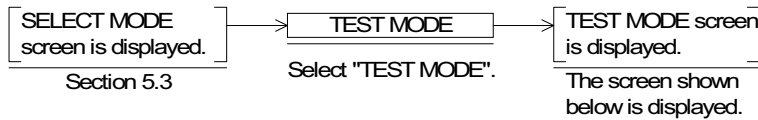

[TEST MODE]	
[TEST MODE]	END
USER SCREEN	a)
DATA BANK	b)
DEBUG	c)
COMMUNICATION MONITOR	d)

- a) USER SCREEN
The list of user screens displayed in screen mode can be displayed.
- b) DATA BANK
Data files created using the screen creation software can be changed. (Not available when using the F930GOT and F933GOT)
- c) DEBUG
Touch key operations and screen changeover operations can be checked. (Not available when using the F930GOT and F933GOT)
- d) Communication monitor
The condition of communication with the connected PLC can be checked. (Not available when using the F930GOT and F933GOT)

11.2 USER SCREEN

When "USER SCREEN" is selected on the TEST MODE screen, the list of user screens displayed in screen mode can be displayed.

Transferred screen data, and display images can be checked.

◆Basic operation

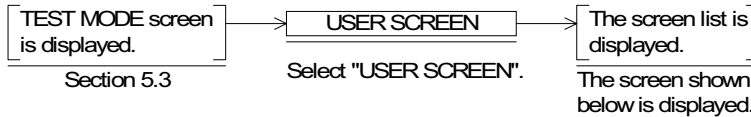

- < Common setting screen > : Displays the screens written in the common setting in the screen creation software.
- Individual screen : When an area indicating a screen No. and a screen name is pressed, the corresponding screen is displayed.
When a screen contains incorrect data and cannot be displayed, "X" is displayed on the side of the screen.

◆ : Scroll the display by one line. ◆ : Scrolls the display by five lines.

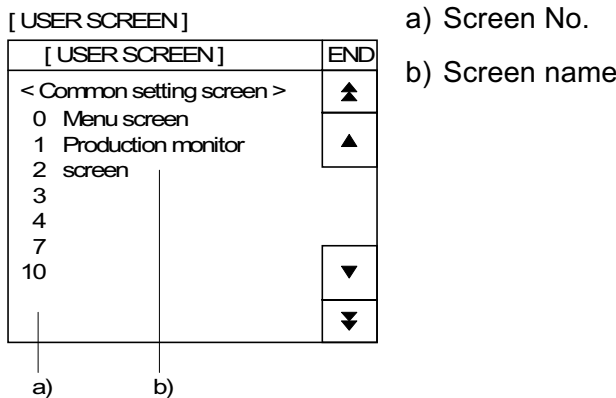

- When a screen to which "x" is added in the individual screen list is pressed, the message window "BAD OBJECT EXISTS" is displayed. In such a case, correct the screen using the screen creation software.

11.3 DATA BANK

Data files created using the screen creation software can be edited.

By selecting the test mode and "DATA BANK" on the screen, data saved in data files can be changed.

The amount of data and the number of files can be set using the screen creation software. The function described here is available only to change the data saved in data files. (When using the F920GOT-K, F930GOT-K, F930GOT and F933GOT, data files can be used but cannot be edited on the GOT screen)

◆Basic operation

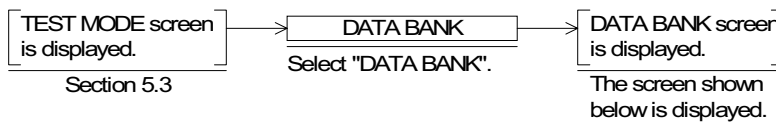

BANK : Allows to specify a file No. The screen No. currently edited is displayed on the screen.

SET : Displays the keyboard and allows to change the data indicated by the cursor.

◆ : Move the cursor. ⬆️⬆️⬆️ : Scroll the display by 14 files.

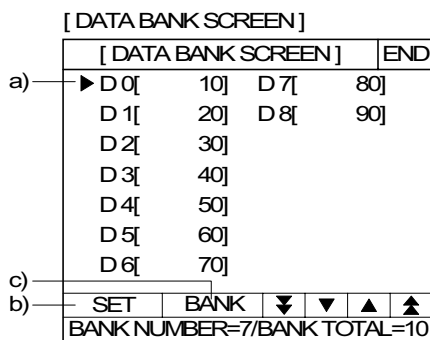

a) Cursor

b) SET
Designates the data to be edited.

c) BANK
Allows selection of a file to be edited.

■Important point

Transfer from a personal computer

When the complete screen data is read from the personal computer, a data file containing the Recipe, Alarm Conditions, Sampling Conditions, and System Settings is transferred to the GOT along with the screen data.

The data file Read/Write characteristics vary per the GOT version as listed below.

- Changes made to the data file in the GOT cannot be read from the GOT.
 - F930GOT or F933GOT: earlier than Version 4.30; F940GOT or F943GOT: earlier than Version 6.30; F940WGOT: earlier than Version 1.30
- Changes made to the data file in the GOT can be read from the GOT.
 - F930GOT or F933GOT: Version 4.30 or later; F920GOT-K or F930GOT-K: from the first product; F940GOT or F943GOT: Version 6.30 or later; F940WGOT: Version 1.30 or later

11.4 DEBUG

The debug function confirms whether the switch functions and screen changeover operations have been performed on the user screens as the user had intended.

The DEBUG screen is overlaid on the user screen. (Excludes F920GOT-K, F930GOT-K, F930GOT, F933GOT)

- HIST.

When the HIST. key is pressed, the history list of up to 20 switch functions (ON/OFF of specified bit devices) and screen changeover operations are displayed. When the number of functions/operations exceed 20, the functions/operations in the history list deleted from the oldest one.

In the history list, screen Nos., touch key Nos., operations and target devices are displayed in this order.

Operations are indicated in abbreviations shown in the table below.

Operation abbreviation	Operation	Target
SWT	Bit operation (momentary)	Controlled bit device
ALT	Bit operation (alternate)	Controlled bit device
SET	Bit operation (set)	Controlled bit device
RST	Bit operation (reset)	Controlled bit device
WRT	Word operation (fixed value)	Written word device
SCR	Screen changeover	Changeover destination Screen No. :K**** Storage :BACK PLC :[K****]

" * " indicates a numeric.

< Display example >

10 TK1 ALT M100: M100 is controlled alternately by the touch key 1 on screen No. 10.

10 TK10 SCR [K15]: The screen is changed over by the touch key 10 on screen No. 10.

The changeover destination is in accordance with an instruction given by the PLC.

When the PLC gives an instruction, the current value of control device (DOO) is displayed and the changeover destination screen No. can be seen.

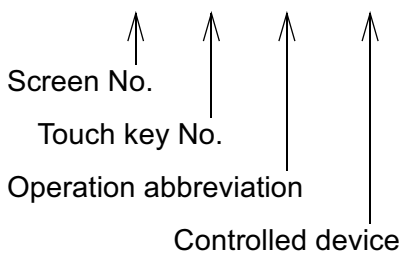

- WATCH

When the WATCH key is pressed, effective settings for screen changeover on the currently displayed user screen are displayed.

Touch key Nos., bit device conditions and changeover destinations are displayed in this order.

< Display example >

TK1 M10 K50 : If M10 is ON when touch key 1 is pressed, the screen is change over to screen No. 50.
The changeover destination is expressed in the same way as the history list.

↑ ↑ ↑
Touch key No. Bit device condition Changeover destination

◆ Basic operation

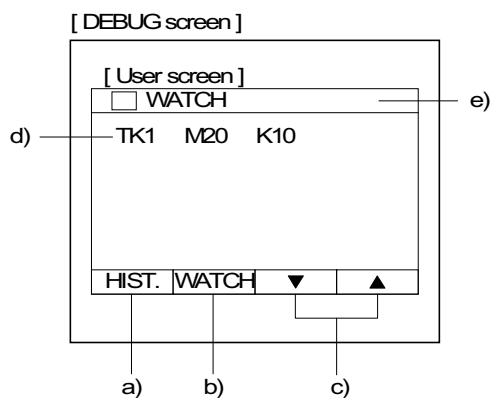
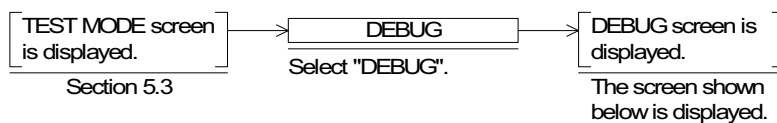

- a) HIST.
Displays the history list of switch operations and screen changeover operations.
- b) WATCH
Displays effective settings for screen changeovers.
- c) Cursor control keys
- d) History/watch list
The history/watch list is displayed using abbreviations described in the previous page.
- e) Window movement
When the area e) is touched and an arbitrary position is touched next, the window is moved to the latter position.

11.5 Communication monitor

11.5.1 Function Outline

The status of each communication port is displayed. (Not available in the F920GOT-K, F930GOT-K, F930GOT, F933GOT)

11.5.2 Applicable version

Product model name	Version
F940, F943GOT	V6.00
F940WGOT	V1.00

11.5.3 Screen Display

Communication monitor screen

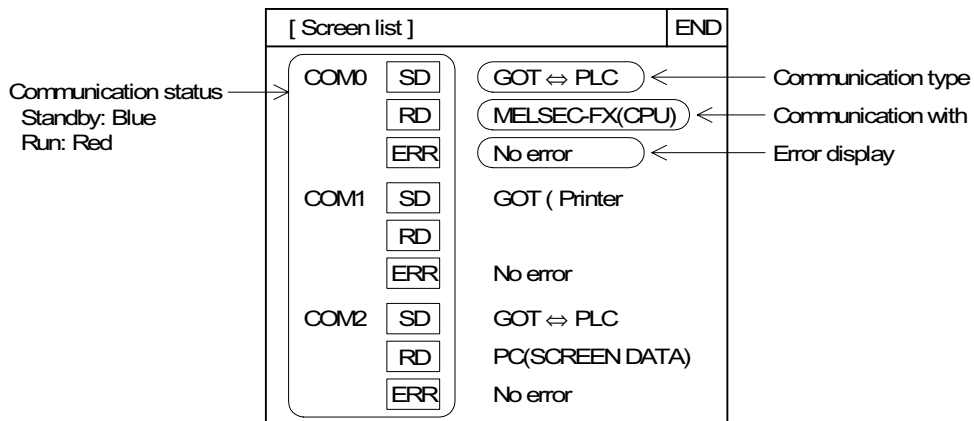

In the case of F940GOT or F943GOT, only COM0 and COM1 are displayed.

- **Communication status**
 The communication status of each port is displayed.
 SD: Sending, RD: Receiving, ERR: Error in communication
 Each item is displayed in "Red" for running, displayed in "Blue" on standby.
 ERR is displayed in "Blue" during normal operation; displayed in "Red" at the time of error occurrence.
 White / black display type GOT: Red \rightarrow white, blue \rightarrow black

- Communication type
The name of units used for communication are displayed.

Display item

Display	Connected to
GOT ⇔ PLC	When the GOT is connected to the PLC
PC ⇔ PLC	When the GOT is connected to a PC The display shown left appears only when the GOT is CPU-connected to the FX, A, QnA or Q Series. Discrimination of the application software (screen creation software/ladder software) is not made on the PC side.
GOT ⇔ PC	When the GOT is connected to a PC The GOT is connected to a PLC manufactured by other companies or units not having a 2PIF function. The PC can use the screen creation software only.
BARCODE ⇔ PLC	When a bar code reader is connected
GOT ⇔ PRINTER	When a printer is connected
GOT ⇔ GENERAL- PUPOSE UNITS	When the GOT is connected to a microcomputer board (general-purpose unit)
GOT ⇔ GOT	When two or more GOT units are connected
NO FUNCTION	Not connected to any units

- Communication display
The model name with which communication is performed, is displayed.

Display item

Display	Connected to
MELSEC-FX(CPU)	When the GOT is connected to FX Series (CPU connection)
MELSEC-A(CPU)	When the GOT is connected to A Series (CPU connection)
MELSEC-A, QnA(CPU)	When the GOT is connected to A or QnA Series (CPU connection)
MELSEC-Q, QnA(CPU)	When the GOT is connected to QnA or Q Series (CPU connection)
MELSEC-A(LINK)	When the GOT is connected to A Series (computer link connection)
SYSMAC C(LINK)	When the GOT is connected to C Series manufactured by OMRON Corporation (computer link connection)
FLEX-PC N(CPU)	When the GOT is connected to FLEX-PC N Series manufactured by FUJI ELECTRIC CO., LTD. (CPU connection)
FLEX-PC N(LINK)	When the GOT is connected to FLEX-PC N Series manufactured by FUJI ELECTRIC CO., LTD. (computer link connection)
AB SLC500(CPU)	When the GOT is connected to SLC500 Series manufactured by Allen Bradley Co., Inc. (CPU connection)
AB MicroLogix(CPU)	When the GOT is connected to MicroLogix Series manufactured by Allen Bradley Co., Inc. (CPU connection)
YASKAWA CP9200SH(CPU)	When the GOT is connected to machine controllers manufactured by YASKAWA Electric Corporation (CPU connection)
SIEMENS S7-200 (CPU)	When the GOT is connected to S7-200 Series manufactured by Siemens AG (CPU connection)
SIEMENS S7-300(CPU)	When the GOT is connected to S7-300/400 Series manufactured by Siemens AG (CPU connection)
MELSEC-FX(2PIF)	When the GOT is connected to a PC or two or more GOT units are connected (Displayed only when the GOT is CPU-connected to FX Series. Discrimination between the screen creation software and the ladder software is not made.)
MELSEC-A(2PIF)	When the GOT is connected to a PC or two or more GOT units are connected (Displayed only when the GOT is CPU-connected to A Series. Discrimination between the screen creation software and the ladder software is not made.)
MELSEC-A,QnA(2PIF)	When the GOT is connected to a PC or two or more GOT units are connected (Displayed only when the GOT is CPU-connected to A or QnA Series. Discrimination between the screen creation software and the ladder software is not made.)
MELSEC-Q,QnA(2PIF)	When the GOT is connected to a PC or two or more GOT units are connected (Displayed only when the GOT is CPU-connected to QnA or Q Series. Discrimination between the screen creation software and the ladder software is not made.)
PC(SCREEN DATA)	When the GOT is connected to a PC (The GOT is connected to a PLC manufactured by other companies and no 2PIF function is used for connecting. The PC can use the screen creation software only.)
FX-GM	When the GOT is connected to FX-10/20GM, FX _{2N} -10/20GM and E-20GM (CPU connection)

Display	Connected to
FREQROL	When the GOT is connected to an inverter, A500, E500 or S500 Series (CPU connection)
MEW FP(CPU)	When the GOT is connected to FP0 or FP2SH Series manufactured by Matsushita Electric Works, LTD.

- Error display
If an error occurs, its description is displayed.

Display item

Display	Connected to
OVERRUNERR	The receive data is continuously transmitted with rapid timing. Match the baud rate (communication speed) of the GOT to that of the equipment with which the GOT communicates.
FRAMINGERR	There is a discrepancy in the communication frame. Check the communication settings such as the data length, stop bit and baud rate.
PARITYERR	The parity check shows a discrepancy. Make adjustment so that the parity check (even/odd) matches.
TEXTERR	There is a discrepancy in the sum data or, the contents of the receive data do not correspond to the transmission command sent from the GOT. Match the communication settings and data contents of the GOT to those of the equipment with which the GOT communicates. (If the GOT is connected to a microcomputer board, a text error is caused when NAK is received.)
TIMEERR	No receive data is transmitted after starting receiving. If the GOT is connected to a microcomputer board, check the terminator, CR, wiring, etc.
LINEERR	The control line does not operate properly. Check the operation and wiring of the control line.
COMMANDERR	The command included in the receive data does not correspond to the transmission command sent from the GOT.
NO ERROR	Normal operation

MEMO

12. Other MODE

This chapter describes the other mode in which convenient functions such as time switch, printer output and system settings are offered.

12.1 Outline of other mode

◆ Basic operation

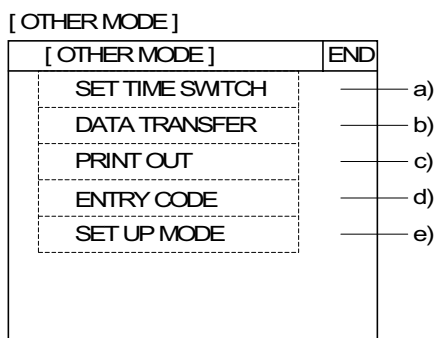
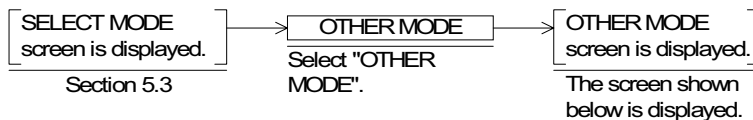

• In 'other mode', the following functions are offered.

- a) SET TIME SWITCH
Turns ON a specified bit device at a specified time. This function is valid when FX-PCS-DU/WIN-E is used.
- b) DATA TRANSFER
Transfers user screens, alarm history and sampling data between the screen creation software and GOT.
- c) PRINT OUT
Prints the sampling data, alarm history, etc.
- d) ENTRY CODE
Registers an entry code to protect sequence programs in the PLC.
- e) SET UP MODE
Allows to set the system settings required to operate the GOT such as the system language and the connected PLC.

12.2 SET TIME SWITCH

Set the time switch using the clock function built in to the GOT.

This function turns ON up to 8 consecutive bit devices during a set time when a specified day of the week and time have come.

Target bit devices can be specified using FX-PCS-DU/WIN-E.

(In the case of GT Designer, this function is available for SW4D5C-GOTR-PACKE(A) or later.)

◆Basic operation

[Operation by touch key]

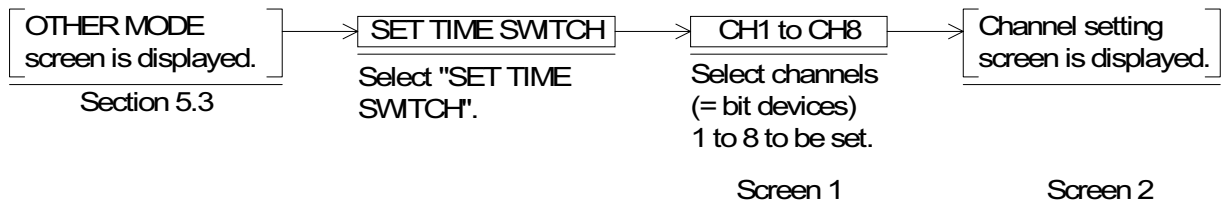

Day of the week: Select desired days of the week by pressing them."●" is added to selected days of the week.

When a day of the week marked with "●" is pressed again, selection is canceled.

START TIME : Set the time at which the specified bit devices turns ON. The devices will remain ON from the start time to the end time on the selected days of the week.

END TIME : If the end time is earlier than the start time, the specified bit devices remain ON until the following day (even if the following day is not selected).

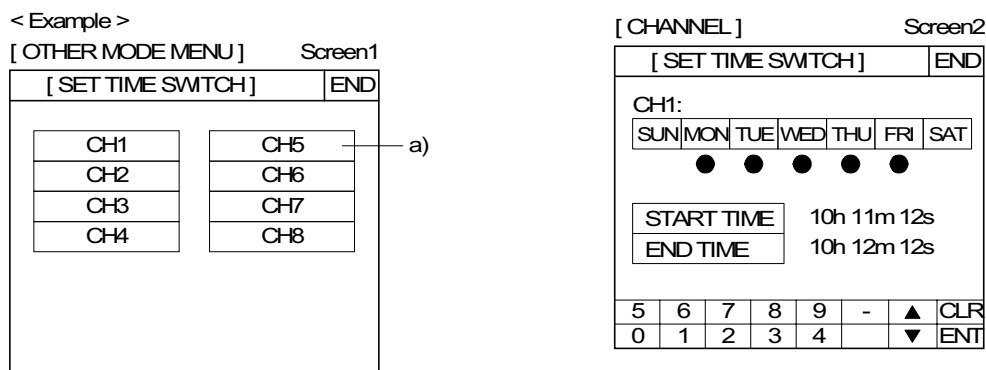

a) Target bit devices

Specify up to 8 consecutive devices.

- In the setting on screen 2, (CH1) M100 will remain ON from 10h 11m 12s to 10h 12m 12s on Monday to Friday.

[Operation in F920GOT-K]

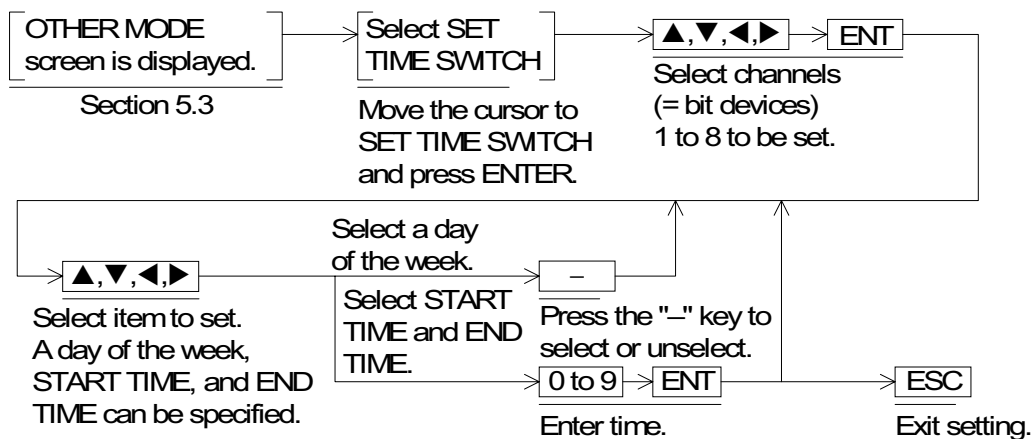

12.3 DATA TRANSFER

The screen data, sampling data and alarm history can be transferred (read/written) between the GOT and a peripheral unit for screen creation (personal computer).

◆Basic operation

- When the screen data is transferred from the personal computer to the GOT, the screen shown below is displayed in the GOT without regard to the screen displayed in the GOT at that time. When transfer is finished, the screen No. 0 is displayed when the FX-PCS-DU/WIN-E is used or the screen No. 1 is displayed when the GT Designer is used. However, if the RS-232C port used to transfer the screen data from the personal computer is set for connection to the PLC, the following operation should be performed to display the DATA TRANSFER screen.

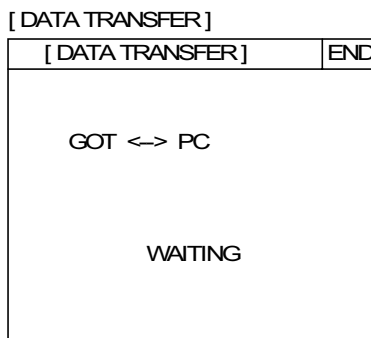
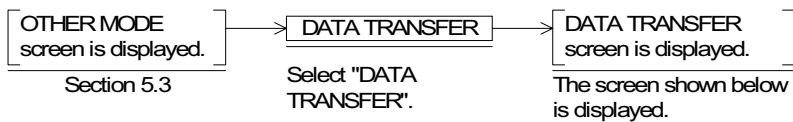

■Important point

- Data transfer to personal computer during sampling

Have in mind the following contents when transferring the data from/to a personal computer while sampling is performed.

 - PC → GOT : Sampling currently performed is aborted.
The sampling data acquired so far is saved.
 - PC ← GOT : Sampling is continued, and the acquired sampling data is saved.

12.4 PRINT OUT

The sampling data and the alarm history can be printed.

As the communication setting can be performed in accordance with each printer, diversified printers equipped with RS-232C interface can be used.

The communication setting for the printer can be performed in "SET-UP MODE" in the GOT or using the screen creation software. (The F920GOT-K cannot be connected to a printer.)

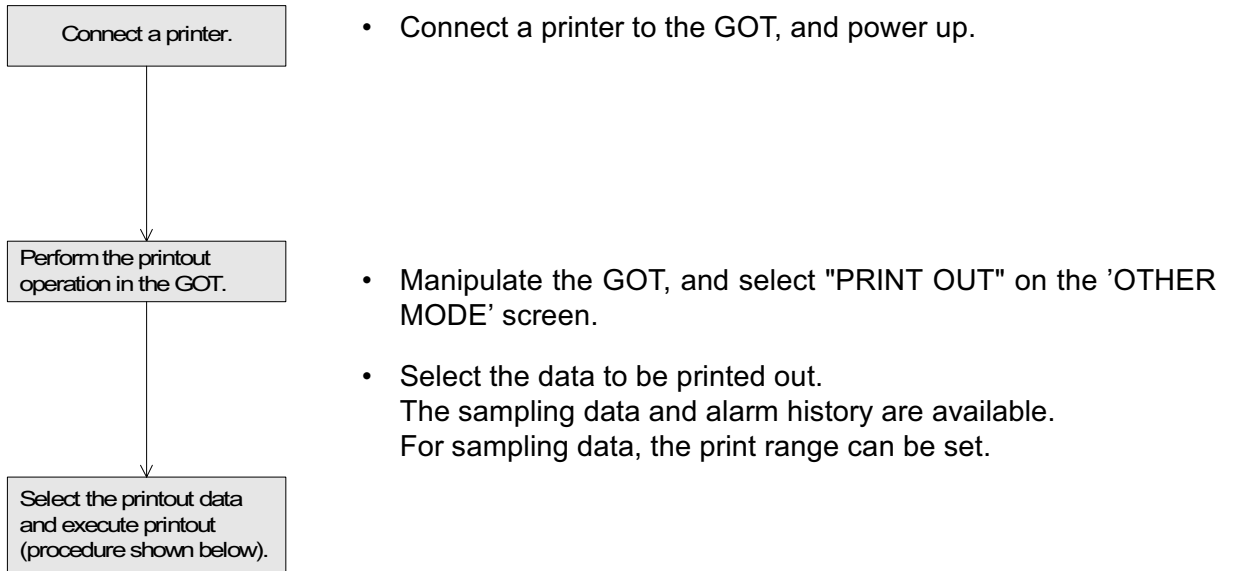

◆ Basic operation

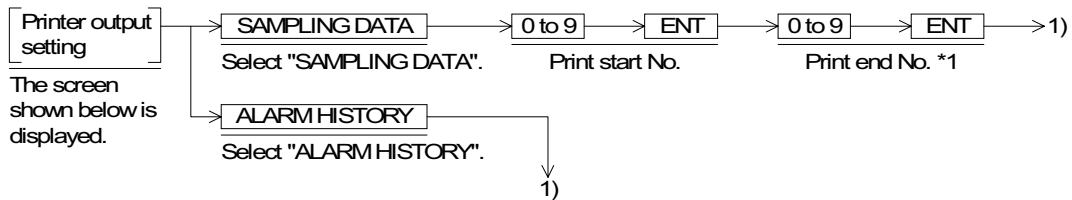

*1 Print end No., do not enter a numeric larger than the value displayed on the screen. (The value displayed on the screen indicates the total number of sampled data.)

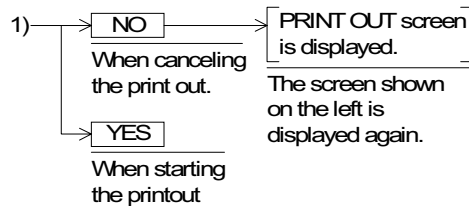
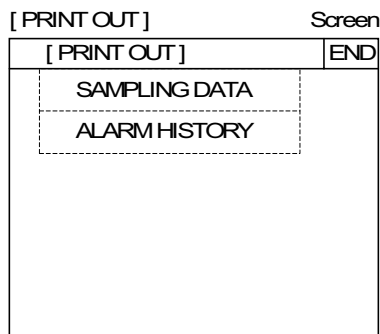

Examples of print out

- Sampling data

```
***** SAMPLING DATA *****
*
* COND. :M 200      OFF->ON      *
*
*
*
*
* START : 27/ 2/1999  19:45:20  *
*
*****
```

NUMBER	TIME	DATA			
1	19:45:23	0	-675	558	7
2	19:45:47	27	0	7142	612
3	19:46:31	262	-765	0	1276
4	19:46:44	262	0	0	0
5	19:47:25	-7329	271	842	6926

↑ Sampling device 1
 ↑ Sampling device 2
 ↑ Sampling device 3
 ↑ Sampling device 4

- Alarm history

```
***** ALARM HISTORY *****
*
* TOTAL :      5      *
*
*
*
*
* START : 27/ 2/1999  19:48:04  *
*
*****
```

NO.	DATE	TIME	MESSAGE
1	27/ 2/1999	19:48:04	TROUBLE #2
2	27/ 2/1999	19:48:08	TROUBLE #1
3	27/ 2/1999	19:48:12	TROUBLE #3
4	27/ 2/1999	19:48:17	TROUBLE #5
5	27/ 2/1999	19:48:22	TROUBLE #3

12.5 ENTRY CODE

When an entry code is registered in the PLC, changes to the set values of timers and counters in the screen mode and monitor mode are forbidden. However, the current values can be changed. (Only the UNLOCK function is available in the F920GOT-K.)

ENTER

Registers an entry code to the PLC.

This entry code is shared by other peripheral units. Enter an 8-digit (FX Series) or 6-digit (A Series) hexadecimal numeric.

INPUT ENTRY CODE: ○○○○○○○○

The entry code becomes effective when the power of the GOT is turned OFF, then turned ON again.

DELETE

Deletes the existing entry code.

The existing entry code can only be deleted after it was first been entered in the unit.

UNLOCK

Temporarily unlocks the existing entry code. (The entry code is kept registered.)

The unlock function is valid until the power of the GOT is turned OFF.

Note:

When you have forgotten the existing entry code, execute "all clear" in a peripheral unit. However, have in mind that all of the data including programs in the PLC are deleted by "all clear". It is recommended not to forget the entry code.

◆Basic operation

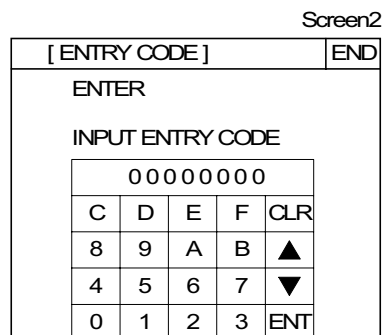
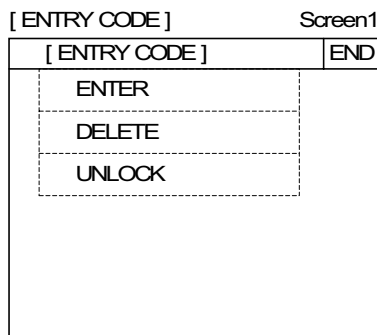
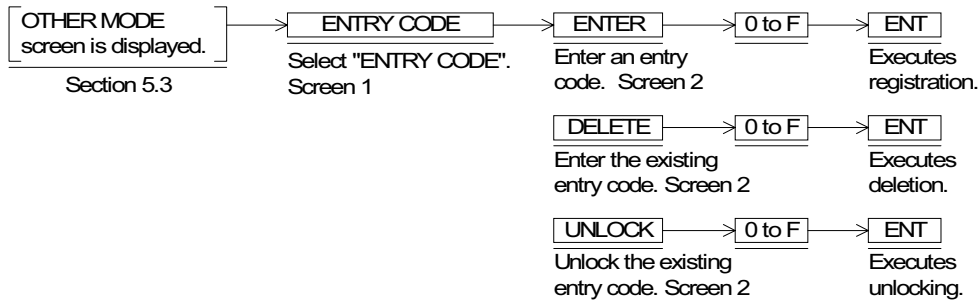

12.6 SET UP MODE

Set the system settings required to operate the GOT such as the system language and connected PLC.

For detailed setting contents, refer to "5 Start up".

◆Basic operation

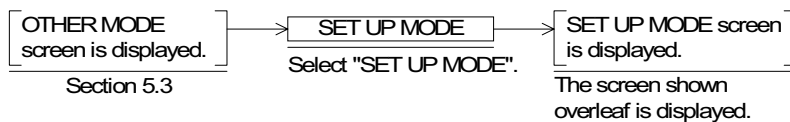

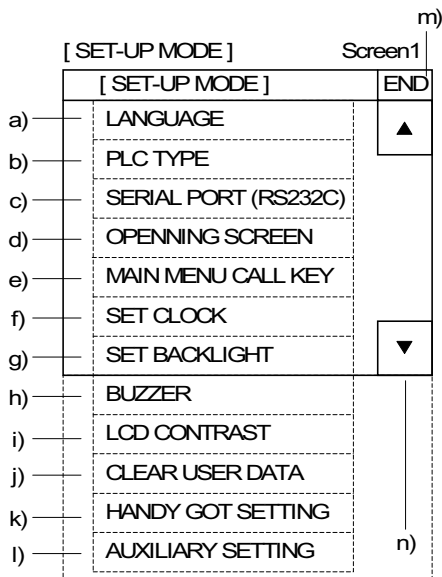

Areas enclosed with broken lines indicate touch keys. (Broken lines are not actually displayed on the screen.)

- a) LANGUAGE
Allows setting of the language displayed on the system screens such as Japanese or English
When "CHARACTER SET" in "LANGUAGE" in "SET-UP MODE" is set to "WEST EUROPE", the following nine languages can be displayed: Italian, English, Dutch, Swedish, Spanish, Danish, German, Portuguese and French
The system language is fixed to English.
(In order to display either of the above languages, create screens using the screen creation software opened on the Windows OS compatible with the corresponding language.
The display of nine languages is provided in the following versions: F930GOT 2.10 or later, F940GOT 4.00 or later, F943GOT 4.00 or later or all of F940WGOT
- b) PLC TYPE
Allows setting of the connected PLC type
- c) SERIAL PORT (RS232C)
To be selected when a printer is connected to the GOT or when communication is performed between the GOT and a microcomputer board
- d) OPENING SCREEN
Allows setting of the duration in which the OPENING SCREEN is displayed immediately after the power is turned ON
- e) MAIN MENU CALL KEY
Allows setting of the position of the touch key which calls the SELECT MODE screen from the USER SCREEN MODE
- f) SET CLOCK
Allows setting of the time used in the time switch and time display
- g) SET BACKLIGHT
Allows setting of the time the backlight is automatically turned OFF, after a period of continuous idle time
- h) BUZZER
Allows setting of the buzzer sound issued when a key is pressed
- i) LCD CONTRAST (F940WGOT: BRIGHTNESS)
Allows setting of the LCD brightness

- j) CLEAR USER DATA
Deletes all user screen data
- k) HANDY GOT SETTING
Allows setting of the grip switch or LED (Only in Handy GOT)
- l) AUXILIARY SETTING
Allows setting of "WRITE" or "DOES NOT WRITE" the initial display screen number to a PLC
- m) END
Exits the SET-UP MODE screen. SELECT MODE is displayed.
- n) Cursors
Change over the menu item on the SET-UP MODE screen

13. Connection to Bar Code Reader

13.1 Outline of function

ASCII code data sent from a bar code reader can be stored in the word devices in the PLC via the GOT. (The F920GOT-K cannot be connected to a bar code reader.)

13.2 Applicable version

GOT

Product model name	Version
F930GOT, F933GOT	V2.00 or later
F930GOT-K	From first product
F940GOT, F943GOT	V2.00 or later
F940WGOT	V1.00 or later

To use this additional function, the following versions of the screen creation software are required.

Screen creation software

Software name	Applicable version
GT Designer	SW1D5C-GOTR-PACKE(H) or later
FX-PCS-DU/WIN-E	V2.00 or later

* If the connected PLC is set for RS-232C, the GOT cannot be connected to a bar code reader. (Does not apply to F933GOT, F943GOT and F940WGOT.)

While screen data is being transferred from a PC or during printing, communication with a bar code reader cannot be performed, as the same RS-232C port is used.

13.3 Connection

Use the RS-232C port of the GOT for connection with a bar code reader.

For wiring between the GOT and a bar code reader, refer to "GOT-F9000 SERIES HARDWARE MANUAL" and the instruction manual of the bar code reader.

MEMO

14. Screen Hard Copy Function

14.1 Outline of hardware copy operation

The screen image being displayed can be output to a printer by issuing a command from a touch key or a bit device in the PLC. (It does not apply to F920GOT-K, F930GOT-K, F930GOT and F933GOT.)

- The screen image being displayed is output to the printer connected to the RS-232C interface of the GOT.
- Setting of the hard copy function is performed in the screen creation software.
- User screens only can be output to a printer. System screens cannot be output to a printer.
- Printing can be started/aborted by setting ON/OFF a corresponding bit device in the PLC or by pressing a corresponding touch key.
- When starting printing, the GOT aborts communication with the PLC for approximately 1 second while storing the displayed screen image in the internal memory. After that, the GOT automatically restarts communication.

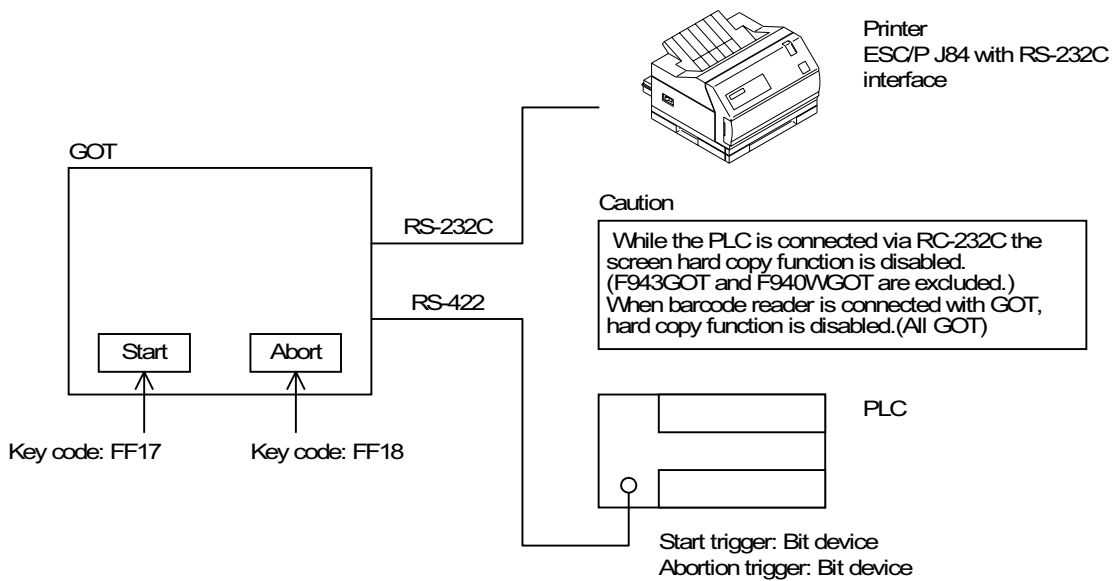

14.2 Applicable version

GOT

Product model name	Version
F920GOT-K	Not possible to use
F930GOT-K	Not possible to use
F930GOT, F933GOT	Not possible to use
F940GOT, F943GOT	V2.00 or later
F940WGOT	V1.00 or later

To use this additional function, the following versions of the screen creation software are required.

Screen creation software

Software name	Applicable version
GT Designer	SW1D5C-GOTR-PACKE(H) or later
FX-PCS-DU/WIN-E	V2.00 or later

14.3 Starting and aborting printing

14.3.1 Start and abortion by triggers

Printing start/abort command is given when a corresponding bit device in the PLC specified in the screen creation software turns ON. The GOT monitors in a constant cycle whether these bit devices have turned ON (monitoring cycle).

The monitoring cycle can be set in the unit of 1 second within the range from 1 to 60 seconds.

* If the bit device ON period is shorter than the monitoring cycle, it may not be recognized as a trigger. Make sure that the ON period is longer than the monitoring cycle.
(Refer to program example shown in 16.3.3.)

14.3.2 Start and abortion by touch keys

Printing can be started and aborted by pressing touch keys.

Assign the following key codes to the touch keys.

	Start	Abort
Key code	FF17	FF18

14.3.3 Hard copy output signal (GT Designer)

The hard copy output signal for the display screen is assigned through system information (when GT Designer is used).

The hard copy output signal cannot be used when FX-PCS-DU/WIN-E is used.

GT Designer

When printing is started by a trigger or touch key, the bit of the following system information turns ON. (Refer to "6.6.2 System information".)

System information	
Hard copy output signal	b7 of "word device specified as head write device +4" becomes ON.

For example, when D20 is assigned as the head write device (refer to 6.6.2.), b7 of D24 turns ON.

When printing is completed or an abort command (trigger or touch key) is given, this bit turns OFF.

- Printing is performed at the following timing.

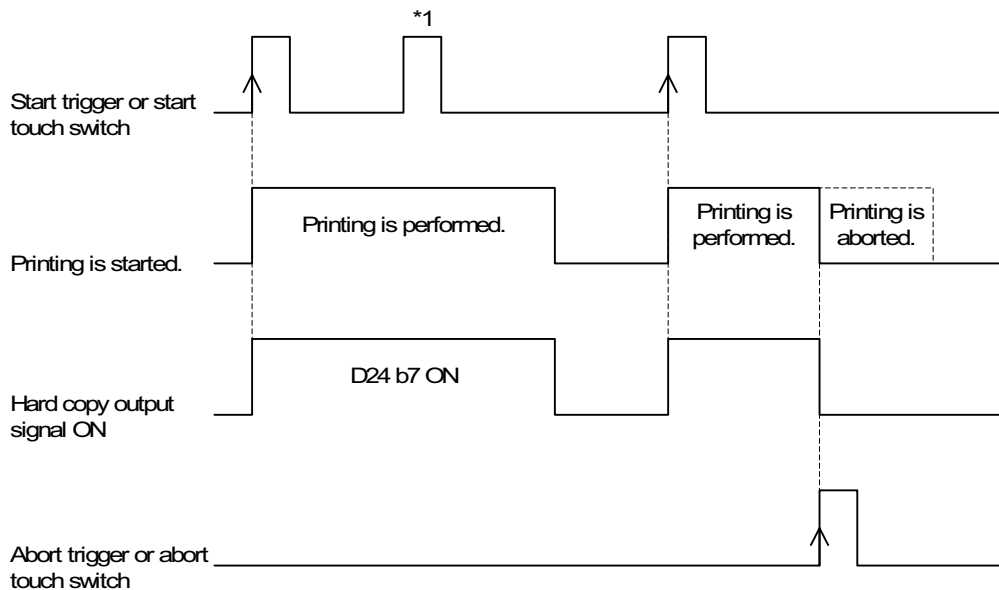

*1 If a printing start command is given while printing is performed, it is ignored and new printing is not performed.

- Sequence program example
 In the program below, a start trigger and an abort trigger are used.
 Start trigger: Assigned to M100
 Abort trigger: Assigned to M101

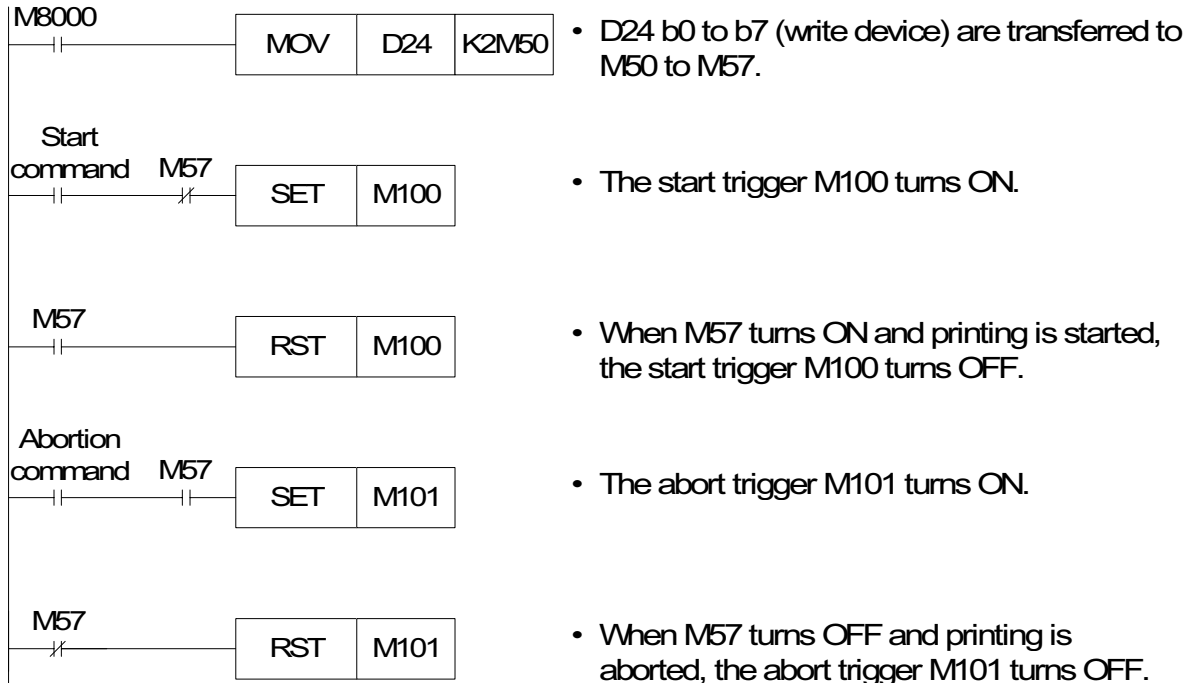

14.3.4 Printing image

All display screens are printed in black and white.
 In the color type GOT, the display colors are converted and printed as follows.

- Screen display colors: Black, red, blue and green → Printed in black
 White, purple, yellow and white → Printed in white
- Highlighting: Black and white on the display screen are reversed in printing.
- Number of screens in one page: The number of screens to be printed in one page can be specified.
- * In some printers, when printing has been aborted, line feeding and page changeover may not be performed by the next printing command.
 After aborting printing, discharge a paper sheet, then restart printing.

15. Buzzer

The buzzer sounds can be issued from the GOT by setting a "Buzzer" object in the screen data (when using FX-PCS-DU/WIN-E) or by using GB (GOT internal bit).

In this chapter, the GB method is explained.

For setting the "Buzzer" object, refer to Section 19.6.12.

15.1 Applicable Version

The buzzer sounds by GB is available in the following versions or later.

GOT

Product model name	Version
F920GOT-K	From first product
F930GOT-K	From first product
F930GOT, F933GOT	V4.40 or later
F940GOT, F943GOT	V6.40 or later
F940WGOT	V1.40 or later

Screen creation software

Software name	Applicable version
GT Designer	SW1D5C-GOTR-PACKE(A) or later
FX-PCS-DU/WIN-E	V2.50 or later

15.2 GB and buzzer sounds

The correspondence between GB and the buzzer sounds is as follows.

GB16: When GB16 turns ON, a short buzzer sounds once.

GB17: When GB17 turns ON, a short buzzer sounds three times.

GB18: While GB18 is ON, the buzzer sound is continuous.

15.3 Use example of buzzer sounds by GB (GT Designer)

When issuing the buzzer sounds by operating the touch key set on the GOT screen, assign the switch function to a touch key as well as one among GB16 to GB18 to a device.

When issuing the buzzer sounds by using the bit device from the PLC, set one among GB16 to GB18 to ON/OFF by observe status function.

The observe status function is to be set in the screen creation software.

Example:

Issuing the buzzer sounds by ON/OFF of auxiliary relay, M100, M200 and M300, of the FX Series PLC.

When M100 turns ON, a short buzzer sounds once.

When M200 turns ON, a short buzzer sounds three times.

While M300 is ON, the buzzer sound is continuous.

- Setting method (GT Designer)
 - a) Select "Observe Status".
 - b) Click "Screen" tab and specify "Base screen" number when setting to a specific screen. Click "Project" tab when setting to the whole project.
 - c) Set "Observe cycle" to "Ordinary".
 - d) Set "Trigger" and "Action" as follows.

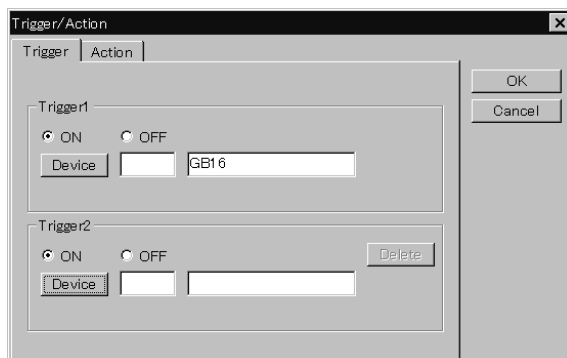

When M100 turns ON, a short buzzer sounds once.

Trigger1: M100 ON

Trigger2: no setting

Action: Momentary

Storing device: GB16 1 point

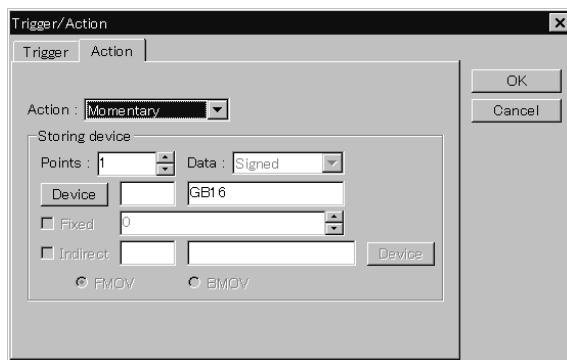

When M200 turns ON, a short buzzer sounds three times.

Trigger1: M200 ON

Trigger2: no setting

Action: Momentary

Storing device: GB17 1 point

While M300 is ON, the buzzer sound is continuous.

Trigger1: M300 ON

Trigger2: no setting

Action: Momentary

Storing device: GB18 1 point

- e) Close the setting screen.

- Set M100, M200 and M300 to ON/OFF respectively by the program in the PLC.

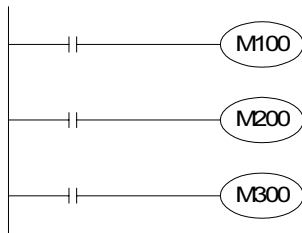

■Important point

- 1) The buzzer sound function is enabled even though a system screen is being displayed.
- 2) The monitor interval greatly changes according to the processing situation (such as the alarm or observe status function).
The pulse change may not be caught if there are many tasks and the pulse interval of the condition devices is short. In order to catch the pulse change, make sure to maintain the ON/OFF status of the condition device for a sufficient length of time.

MEMO

16. Observe Status Function

The observe status function monitors the ON/OFF status of specified bit devices, then turns a bit device in the PLC ON/OFF or, writes a numeric value to word devices in the PLC from the GOT in accordance with changes in the monitored ON/OFF status.

16.1 Outline of observe status function

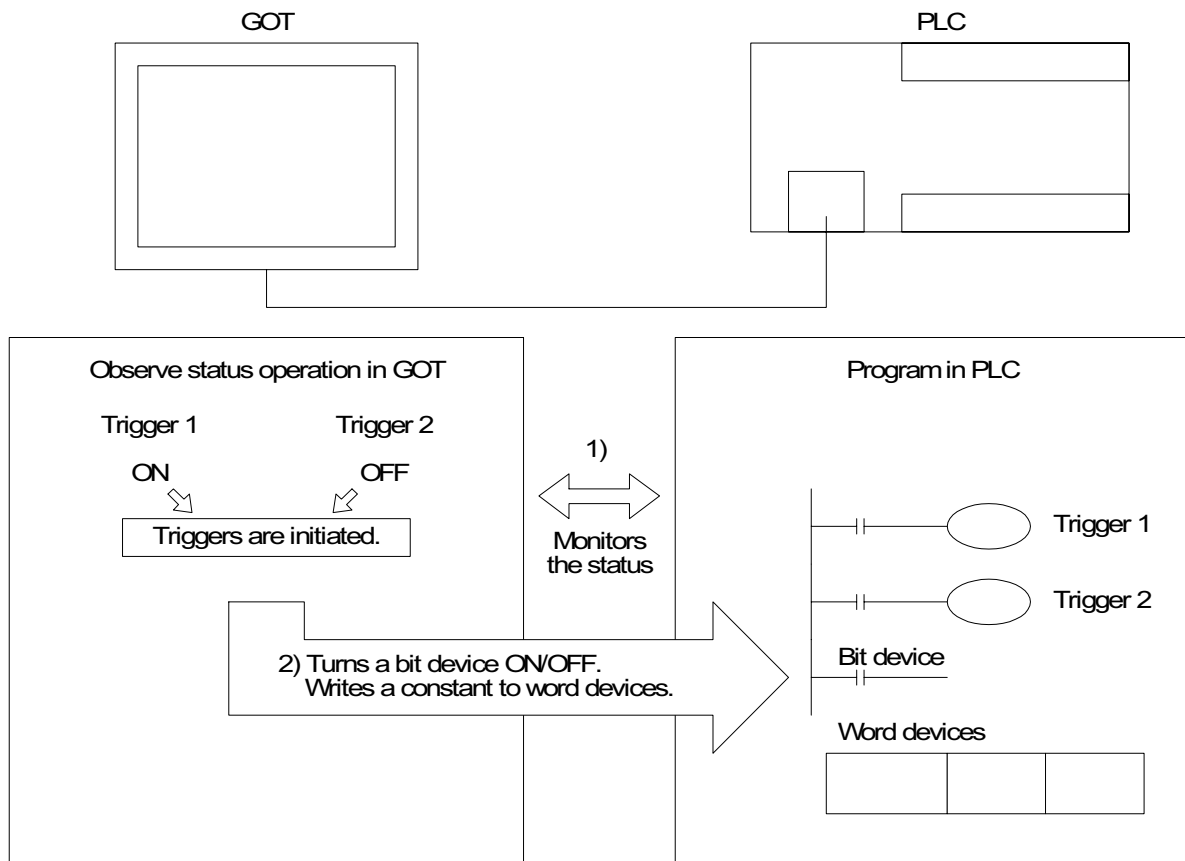

- 1) The GOT monitors always or at a constant cycle whether bit devices specified as triggers are ON or OFF. (The ON/OFF status for triggers can be specified using the screen creation software. Refer to the next page.)
- 2) When specified triggers are initiated, the GOT turns a specified bit device ON/OFF or writes a constant to specified word devices.

16.2 Applicable version

GOT

Model name	Version
F920GOT-K	From first product
F930GOT-K	From first product
F930GOT, F933GOT	V2.00 or later
F940GOT, F943GOT	V3.10 or later
F940WGOT	V1.00 or later

Screen creation software

Software	Applicable version
GT Designer	SW1D5C-GOTR-PACKE(C) or later
FX-PCS-DU/WIN-E	V2.50 or later

16.3 Observe cycle

Set the cycle at which the GOT monitors whether the specified triggers are initiated. Select "Ordinary" or "Sampling".

- Always:
Every time communication is performed between the GOT and the PLC, the GOT monitors whether the specified triggers are initiated. (every 200 to 300 ms.)
- Sampling: The cycle can be set from 1 to 60 seconds with an increment of 1 second. At the set cycle, the GOT monitors whether the specified triggers are initiated.

When using the F920GOT-K, the monitor interval greatly changes according to the processing situation (such as the alarm or observe status function).

The pulse change may not be caught if there are many tasks and the pulse interval of the condition devices is short. In order to catch the pulse change, make sure to maintain the ON/OFF status of the condition device for a sufficient length of time.

16.4 Setting the triggers

Set the triggers to be monitored.
Up to two bit devices can be set.

- Trigger 1: Set ON or OFF of a bit device.
- Trigger 2: Set ON or OFF of a bit device.
 - When trigger 1 and trigger 2 are set, the GOT performs the operation described in the next section only when both triggers are initiated.

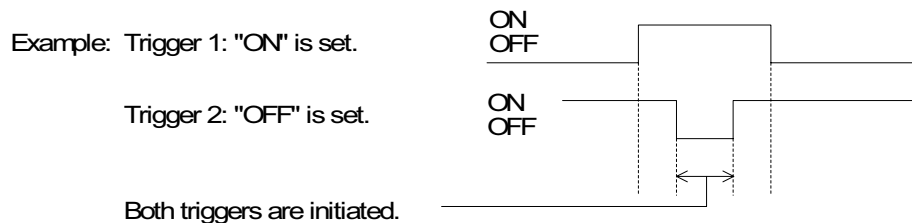

- Make sure to set trigger 1. Set trigger 2 if necessary.

16.5 Setting the operation

This section describes the operation performed when the triggers set in the previous section are initiated.

During operation, a bit device can be turned ON/OFF or data can be written to word devices. One type of operation can be selected for the triggers set in the previous section.

1) Operation of bit device

- Momentary

When specified triggers are initiated, a specified bit device turns ON.

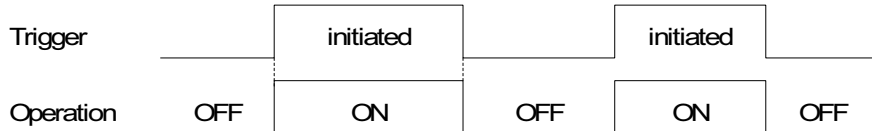

- Set

When specified triggers are initiated, a specified bit device turns ON.

Even if the specified triggers are released after the specified bit device turns ON, it remains ON.

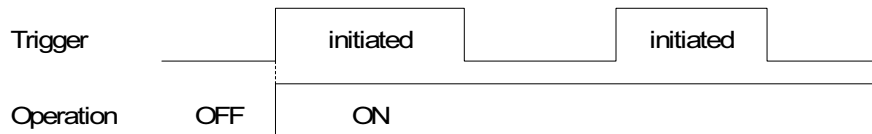

- Reset

When specified triggers are initiated, a bit device turns OFF.

Even if the specified triggers are released after the specified bit device turns OFF, it remains OFF.



- Alternate

When specified triggers are initiated, the current status of a bit device is inverted. (If the specified bit is ON, it turns OFF. If it is OFF, it turns ON.)

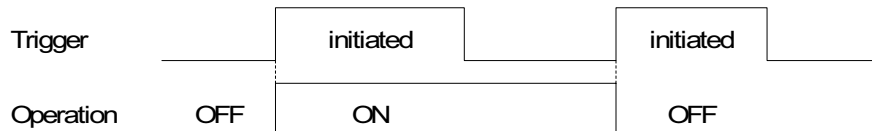

2) Operation of word devices

When specified triggers are initiated, a fixed value or a "fixed value + current value of an indirectly specified word device" is written to specified word devices.

- Fixed

When specified triggers are initiated, a 16-bit or 32-bit value is written to a determined word devices.

The fixed value should be decimal.

Operation example: When specified triggers are initiated, a fixed value "200" is written to D100 to D103.

Fixed value Write 16-bit storing word device: D100

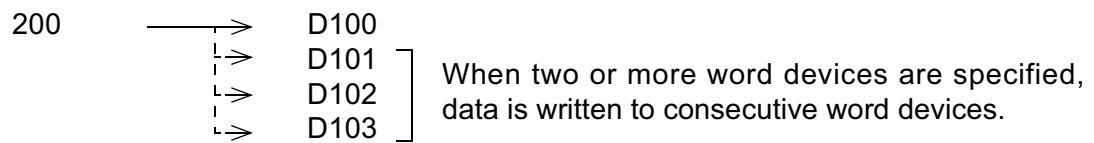

For the number of storing devices, refer to the next section.

- Fixed + Indirect

When specified triggers are initiated, a fixed value added to the current value of an indirectly specified word device is written to specified word devices.

* The fixed value should be set. Setting of an indirect device only is disabled.

16.6 Trigger and number of devices

The table below shows the number of registration points available in the observe status function.

- Triggers can be registered for each project or screen (No. 1 to 500).

Maximum number of registered triggers	
Each project 40 points	80 points in total
Each screen 40 points	

*When screens are overlapped or a screen is called, triggers registered on the base screen are valid.

- The table below shows the number of storing devices for one trigger.

Bit devices		For "Momentary", "Set", "Reset" and "Alternate" 1 to 40 points in total
Word devices	16-bit	For "Signed" and "Unsigned" 1 to 20 points in total
	32-bit	For "Signed" and "Unsigned" 1 to 10 points in total

- Many triggers and storing devices can be registered as shown above. However, the registered contents and the number of registered points give effect on the response time of the GOT. Confirm the cautions described in the next section.

16.7 Cautions when many triggers and devices are set

When many points are registered or when many observe status operations are performed as described below, it takes considerable time until the operations are completed. As a result, the response time of the GOT may be affected.

- When selecting "Momentary" for "Action" and setting a large number of points for "Storing device" in "Trigger/Action".
- When many triggers are initiated causing a high number of write operations to be performed. Especially when the observe status cycle is set to "always" or the cycle has a short set time.

Effect on GOT

- Effect on functions and objects which are actuated at a constant cycle:
Functions which are cyclically actuated may not be executed in accordance with their setting. For example, the observe cycle, sampling function, alarm history/list function, the current time function and the trend graph function may be affected.
- Effect on screen data transfer:
When the display is automatically changed to the DATA TRANSFER screen and screen data is transferred, the error message may be displayed in the screen creation software. In such a case, changeover the display to the DATA TRANSFER screen by key operation. Then, screen data can be sent and received.
- Effect on the monitoring function, screen changeover function and key operation:
Specified operation may be delayed for screen changeover, monitoring and key operation in the same way described above.
- Effect on the built-in 2-port interface function:
When circuit monitoring, device batch processing or monitor registration is executed in a peripheral unit, a communication error may occur in that unit.

16.8 Use example (utilization of clock data)

Clock data built in the GOT can be transferred to a data register in the PLC for utilization while a specified bit device is ON. The clock data is stored in the following registers. GT Designer (from first product) or DU/WIN-E (V2.50 or later) can handle these registers. (This example is not applicable for the F920GOT-K because the clock data is not built in.)

GD0: Current time (second)	GD1: Current time (minute)
GD2: Current time (hour)	GD3: Current time (day)
GD4: Current time (month)	GD5: Current time (year)
GD6: Current time (day of week)	

Example: When the clock data (year, month, day, hour, minute and second) is transferred to register D100 in the PLC at every 30 seconds while M10 is ON

Select "Observe Status" in the screen creation software.

- 1) Select "Project", and set the cycle to 30 seconds.
- 2) Set Trigger1 to "M10, ON".
- 3) Select "Word Set (16bit)" for Action, and set the number of points to "7".
- 4) Set "Device" in storing device to "D100", "Fixed" to "0" and "Indirect" to "GD0".
- 5) Set the transfer method to "BMOV".

When this data is transferred to the GOT, the current time is stored in D100 at every 30 seconds while M100 is ON.

MEMO

17. Key Pad (F920GOT-K and F930GOT-K)

This section describes handling of the key pad in the F920GOT-K and the F930GOT-K.

17.1 Function keys

The F920GOT-K unit is equipped with six function keys and the F930GOT-K unit is equipped with eight function keys with green LEDs. For each function key, a switch, data write or screen changeover operation can be assigned.

(Two or more switch or data write operations can be set to one function key.)

17.1.1 Assignment of function keys

In the F920GOT-K, the function keys are assigned as "X000: External key 0", "X001: External key 1", ... "X005: External key 5" from the left.

In the F930GOT-K, the function keys are assigned as "X000: External key 0", "X001: External key 1", ... "X003: External key 3" from the left to the right in the upper row, and as "X004: External key 4", "X005: External key 5", ... "X007: External key 7" from the left in the lower row. Assign an arbitrary operation to each key using the screen creation software.

- When using GT Designer

Assign an operation by selecting "Common" → "Operation Panel".

The setting of the function keys is handled in the unit of project. (The function keys cannot be set for each screen.)

- When using FX-PCS-DU/WIN-E

Assign an operation by selecting "Keys" → "External Key".

(The function keys can be set for each screen.)

- When using GT Designer and FX-PCS-DU/WIN-E, key codes cannot be assigned to function keys.

[Setting example in GT Designer (F930GOT-K)]

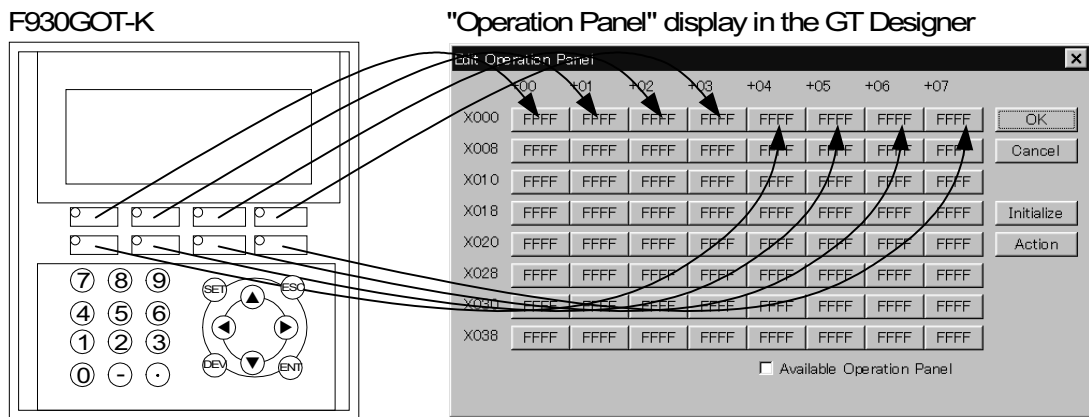

[Setting example in the FX-PCS-DU/WIN-E (F930GOT-K)]

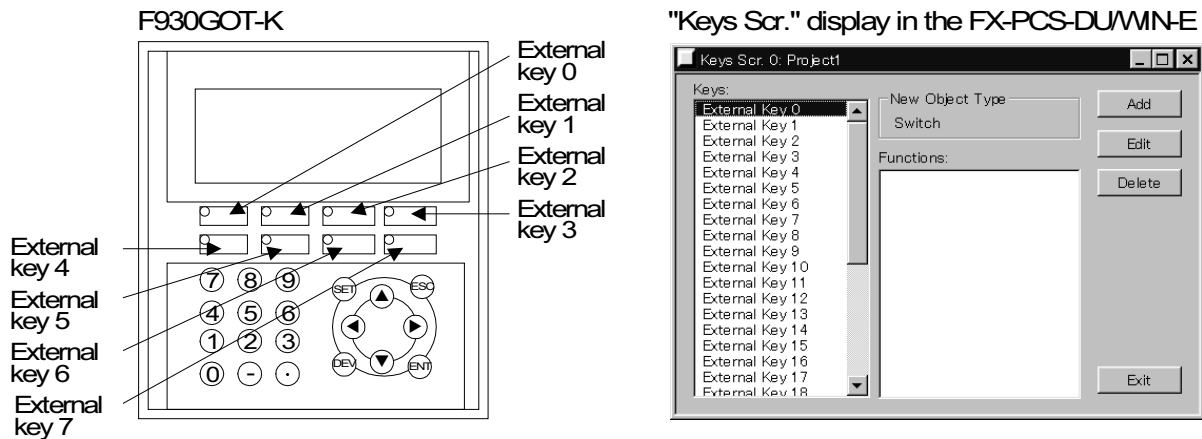

17.1.2 Assignment of LEDs (F930GOT-K)

Each function key in the F930GOT-K is equipped with a green LED which can be set to ON and OFF using an arbitrary device.

Assign a device in "Output Indicator" (Lamp (External)) in the screen creation software.

Eight devices are occupied from the device No. set in "Output Indicator" (Lamp (External)). When the set device is ON, the green LED is ON. When the set device is OFF, the LED is OFF. If no device is set, the LED is always OFF.

- The setting of "Output Indicator" (Lamp (External)) is handled in the unit of project. (It cannot be set for each screen.)

[Setting in "Lamp" in the GT Designer]

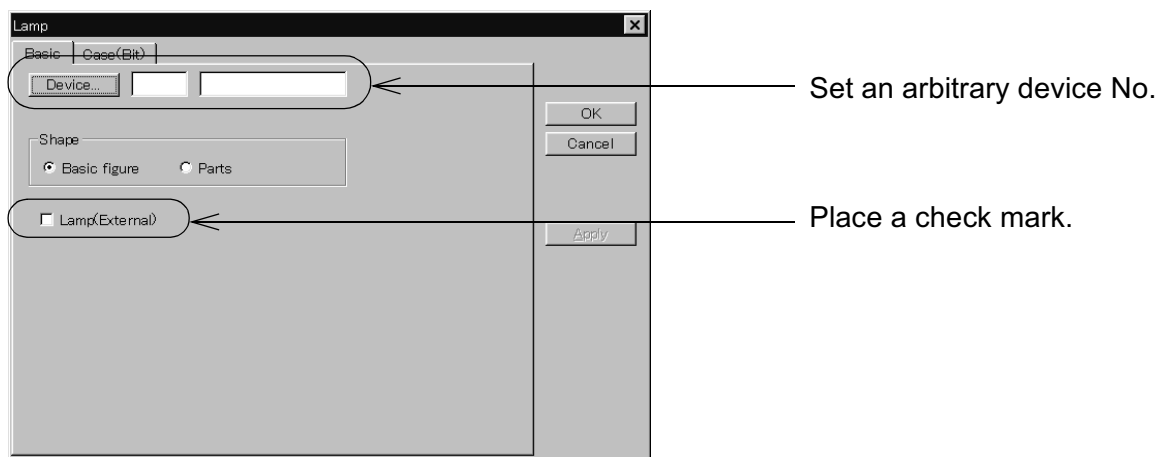

[Setting in "Output Indicator" the FX-PCS-DU/WIN-E]

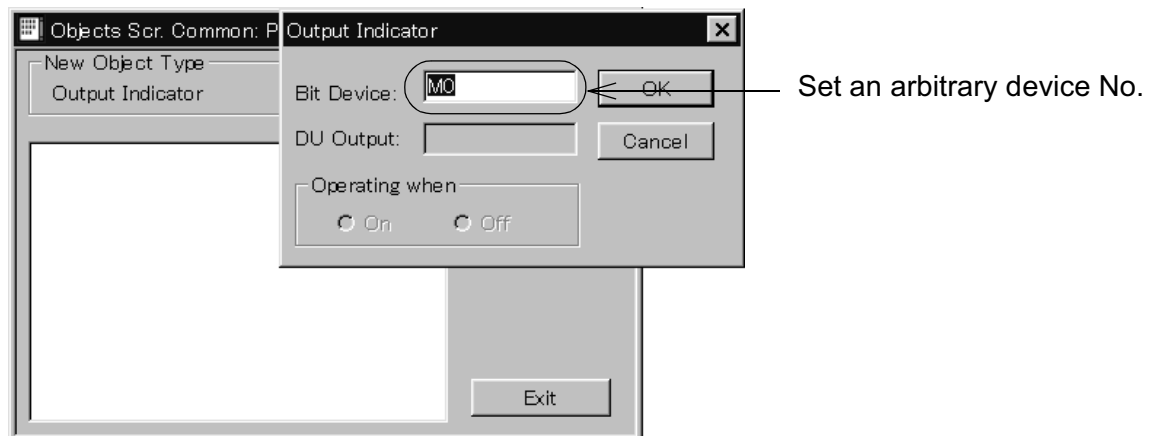

- When using the FX-PCS-DU/WIN-E, set "Output Indicator" in "Common screen". (It cannot be set for each screen.)

17.2 Handling of ten-keys, cursor control keys, "SET" key, "DEV" key, "ESC" key and "ENT" key

In the F920GOT-K and the F930GOT-K, values in "suuchi nyuuryoku?" and "asukii nyuuryoku?" (0 to 9) can be changed using the ten-keys, the cursor control keys, the "SET" key, the "ESC" key and the "ENT" key.

(The "DEV" key is not used in the data input operation.)

- Ten-keys "0" to "9", "-" and "."
Used for entering a numeric value in the data input operation.
- Cursor control keys "<◀", "▶", "▲" and "▼"
Used for moving the cursor in the data input operation.
- "SET" key. Used for displaying the cursor in the data input operation.
- "ESC" key Used for canceling the data input operation.
- "ENT" key Used for determining the input numeric value in the data input operation.

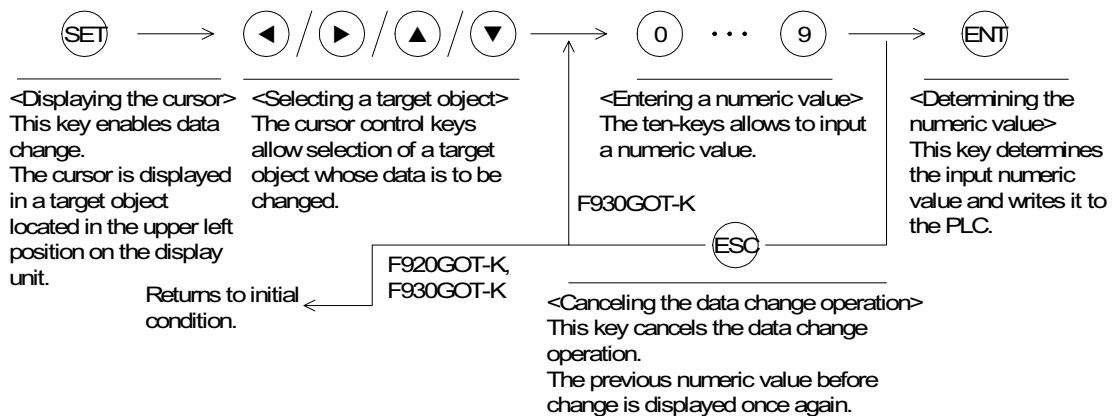

- If any character other than "0" to "9", "-" and "." is required to be entered as "Ascii Input" in the F930GOT-K, enter it from the key window. (Refer to Section 7.6.3).
- In the F920GOT-K, any character other than "0" to "9", "-" and "." cannot be entered.
- When entering hexadecimal numbers in the F920GOT-K, switch from decimal input mode to HEX input mode by pressing the "." key.
In the HEX input mode (when HEX is displayed on the right on the screen), "A", "B", "C" ... and "F" are entered when "1", "2", "3" ... and "6" keys are pressed respectively.
- When changing data using the GT Designer, the display pattern and movement of the cursor varies depending on the setting in the screen creation software.
Perform the settings in "Screen" and "Project" available by selection of "Common" → "Auxiliary Setting" from the menu bar in the screen creation software. (For the details, refer to Section 7.)

18. Creation of Display Screens (FX-PCS-DU/WIN-E)

This chapter describes parts in constructing user screens using FX-PCS-DU/WIN-E. Created user screens are displayed in the screen mode (described in Chapter 7). For specification of screens to be displayed, refer to Chapter 19.

18.1 Parts list

Parts for constructing screens are referred to as "Objects" in FX-PCS-DU/WIN-E.

◆Display example

The figure below shows an example of screen display. Only a few objects are used in the example below. Some objects are displayed on the screen, and others are not. Some objects are only available in certain models.

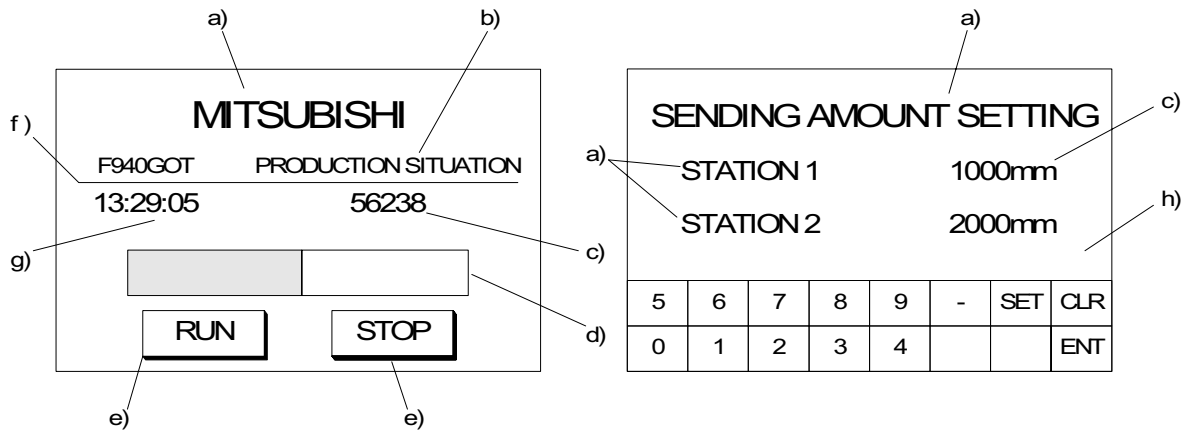

Display objects: Display the data in a specified size in a specified position.

Object name	Description	Use example
Text	Displays alphabets, numerics, symbols.	a), b)
Line	Displays a line connecting two specified points.	f)
Box	Displays a box on the screen.	---
Filled Box	Displays a boxed filled with a specified color on the screen.	---
Circle	Displays a circle on the screen.	---
Filled Circle	Displays a circle filled with a specified color on the screen.	---
Image	Displays an image stored in the image library in a specified position on the screen.	---
Date	Displays the year, month, day and day of the week.	---
Time	Displays the hour, minute and second.	g)

Data display objects: Display the contents of devices in the PLC.

Object name	Description	Use example
Library Text	Displays text stored in the text library. The text to be displayed can be specified using a word device (T, C, D, V or Z).	---
Number	Displays a word device (current value/set value of timer/counter or D, V or Z) in the PLC in a specified position for monitoring.	c)
Bar Graph	Displays a word device (current value/set value of timer/counter or D, V or Z) in the PLC in a specified position in the form of bar graph for monitoring.	d)
Circle Graph	Displays a word device (current value/set value of timer/counter or D, V or Z) in the PLC in a specified position in the form of circle graph for monitoring.	---
Proportional Bar Graph	Displays up to 8 consecutive word devices in the form of a proportional bar graph.	---
Proportional Pie Graph	Displays up to 8 consecutive word devices in the form of a proportional pie graph.	---
Panel Meter	Displays a word device in the form of panel meter.	---
Indicator	Inverts a specified area on the screen by setting a bit device in the PLC ON or OFF.	---
Label Indicator	Displays specified characters when a specified bit device becomes ON.	---
Text Indicator	Displays two types of texts alternately in accordance with the ON/OFF status of a bit device in the PLC. Texts stored in the text library can be specified for display.	---
Image Indicator	Displays two types of images alternately in accordance with the ON/OFF status of a bit device in the PLC. Images stored in the image library can be specified for display.	---
Overlay Screen	Allows a specified screen to overlay another screen when a bit device in the PLC becomes ON or OFF.	---
Library Image	Displays an image stored in the image library. The image can be specified using a word device (T, C, D, V or Z).	---
Trend Graph	Displays word devices in the PLC sampled at a constant time interval in the form of trend graph. Up to 4 devices can be displayed.	---
Line Graph	Acquires data stored in a word device at each specified timing, displays a line graph of the acquired data within the display range, then allows scroll of the line graph.	---
Ascii	Allows a character code to be specified from the PLC, and displays a corresponding character such as alphabet, numeric. ASCII code is available as character codes.	---

Data transfer objects: Transfer data when a key is pressed.

Object name	Description	Use example
Switch	Controls the ON/OFF status of a bit device in the PLC from a touch key.	---
Touch Key	Allows a specified area on the screen to function as a key when pressed. The "Touch Key" object is usually combined with a function such as "Switch" and "Data Setting".	e)
Send Data Bank	Stores data on up to 4,000 data registers in the PLC. When a specified input is given, data can be read from or written to corresponding data registers.	---
Write Constant	When a specified touch key is pressed, set data is written to a word device in the PLC.	---
Data Setting	Allows change to a specified word device in the PLC. When a key is pressed, a ten-key pad is displayed on the screen so that a specified numeric can be changed.	---
Increment	Adds "1" to the data of a specified word device in the PLC.	---
Decrement	Subtracts "1" from the data of a specified word device in the PLC.	---
Keyboard	Displays a keyboard dedicated to numeric change on the screen.	h)
Buzzer	Issues buzzer sound in the GOT in accordance with the ON/OFF status of a bit device in the PLC.	---

Screen changeover object

Object name	Description	Use example
Change Screen	Allows to specify the screen changeover condition, destination, etc.	---

18.2 Application and setting item

In some applications, two or more items (objects) are set.

Main applications and set items

Application	Set item (object name)		
Character display	Text		
	Library Text	Text Library	
Numeric value display/Numerical input	Number		
ASCII character display / ASCII data input	Ascii		
Drawing (rectangle, circle, straight line)	Box		
	Circle		
	Line		
Display of bit map file	Image	Image library	
Graphic display	Bar Graph		
	Circle Graph		
	Panel Meter		
	Proportional Bar Graph		
	Proportional Circle Graph		
	Trend Graph		
	Line Graph		
Display color reversing (bit device specification)	Indicator		
	Label Indicator		
Character display changeover (bit device specification)	Text Indicator	Text library	
Screen overlay display (bit device specification)	Overlay screen	Display screen	
Screen overlay display (word device specification)	(Choose "PLC data register" for "Destination Screen" in "Change Screen".)	Interface Devices	Display screen
Bitmap file changeover display (bit device specification)	Image Indicator	Image library	
Buzzer sound setting (bit device ON)	Buzzer		
Date display	Date		
Time display *1	Time		

Application	Set item (object name)		
Display of touch key ^{*2}	Touch key		
Bit device ON/OFF by the touch key	Switch		
Writing/Reading of current values of two or more data (Trigger setting using a bit device is possible.)	Send Databank	Data Banks	
Data increment	Increment		
Data decrement	Decrement		
Ten-key keypad display (touch key specification) and numeric input	Data setting	Number	
Writing of fixed data (touch key specification)	Write Constant		
Display screen changeover (touch key specification)	Change screen	Changeover-to screen	
Display screen changeover (PLC specification)	Change screen (PLC specification)	Changeover-to screen	Interface Devices
Permanent display of ten-key keypad	Keyboard		
Display of alarm history ^{*1}	Alarm history	Alarm setting	
	Alarms	Screen changeover (The system screen number of the changeover-to screen should be specified and the changeover-from screen should be stored.)	
Display of alarm list ^{*1}	Alarm list (user alarm)	Text library	
	Alarms	Screen changeover (The system screen number of changeover-to screen should be specified and the changeover-from screen should be stored.)	
An alarm message is displayed while being shifted or two or more alarm messages are sequentially displayed.	Alarms (Choose "Moving Alarm" for "Report" in "Individual Settings".)	Text library	

- *1 When using the F920GOT-K, clock data in the PLC is displayed.
Time display enabled only when connected to the PLC with the clock function.
Display of alarm list--date and time is not displayed.
- *2 When using the F920GOT-K, allocate each function to a function key.
When using the F930GOT-K, these functions can be allocated to either touch keys or function keys.

18.3 Registration of object

In FX-PCS-DU/WIN-E, objects can be registered to all screens or only one screen at a time.

- **Setting for all screens (common setting)**

An object registered in the setting for all screens is shared by all screens.

Available objects: All objects

- **Setting for individual screen**

An object can be registered for an individual screen. Only the functions of the object registered on the screen currently displayed are effective. When the display screen is changed over, objects registered on the newly displayed screen become effective.

Available objects: All objects

- The figure below shows the relationship between the setting for all screens and the setting for individual screen.

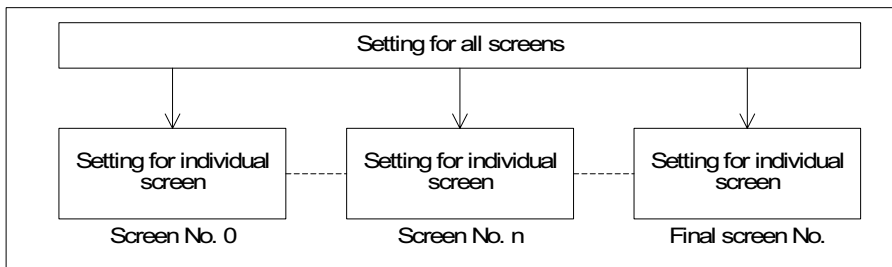

On the screen displayed, both objects registered in the setting for all screens and the objects registered in the setting for individual screen are effective.

■ Important point

When an object is registered in the setting for all screens, it acts as if one screen overlays by the screen call function.

18.4 Display objects

This section describes in details the objects related to display of characters and images on the screen.

18.4.1 Text

An object used to display characters is called "Text". "Text" objects are used to give messages indicating operation or error status to an operator.

◆Contents of setting

Attribute	Contents of setting
Position	Enter the X and Y coordinates of the start point in the unit of dot.
Bg, Text and Bg Transparent	Enter the background color and the text color. (Initial values: White and black) When "Bg Transparent" is selected with a check mark, the setting of "Bg" is not effective.
Character Size	Enter the width (W) and the height (H). The available sizes are $\times 0.5$, $\times 1$, $\times 2$, $\times 3$ and $\times 4$.
Shift	The text can be shifted to the right, the left or the center.
Text	Enter the characters to be displayed. Available characters are alphabets and numerics. The text may occupy two or more lines.

◆Display example

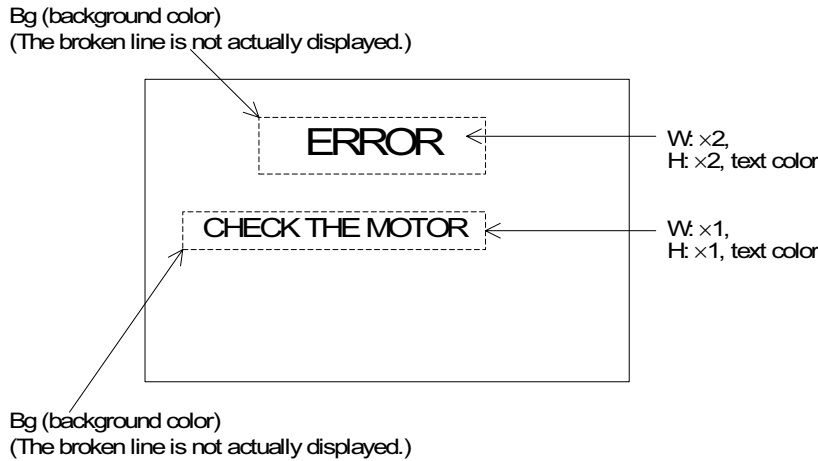

18.4.2 Line

The "Line" object displays a line on the screen.

◆Contents of setting

Attribute	Contents of setting
Start Position	Enter the X and Y coordinates of the start point of the line in the unit of dot.
End Position	Enter the X and Y coordinates of the end point of the line in the unit of dot.
Color (Line button)	Enter the display color. (Initial value: Black)

◆Display example

- A line is drawn in solid line.

Example:

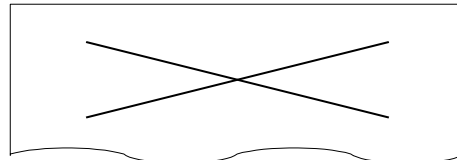

- Use lines to draw polygons, except squares or rectangles.

18.4.3 Box

The "Box" object displays a rectangle having specified two diagonal points.

◆Contents of setting

Attribute	Contents of setting
Position	Enter the X and Y coordinates of one diagonal start point in the unit of dot.
Size	Enter the W and H by the unit of dot.
Color (Frame button, Fg button and Bg button)	Enter the display color. (Initial value: Black)

◆Display example

- A square or rectangle is drawn in a solid line.

Example:

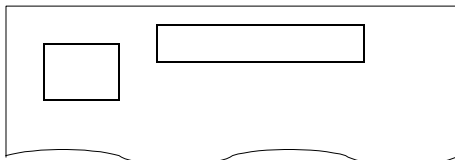

- Use lines to draw polygons, except squares or rectangles.

18.4.4 Filled Box

The "Filled Box" object displays a filled rectangle having specified two diagonal points.

◆Contents of setting

Attribute	Contents of setting
Position	Enter the X and Y coordinates of one diagonal start point in the unit of dot.
Size	Enter the W and H by the unit of dot.
Color (Frame button and Fill button)	Enter the frame color and the filling color. (Initial values: Black and white)

◆Display example.

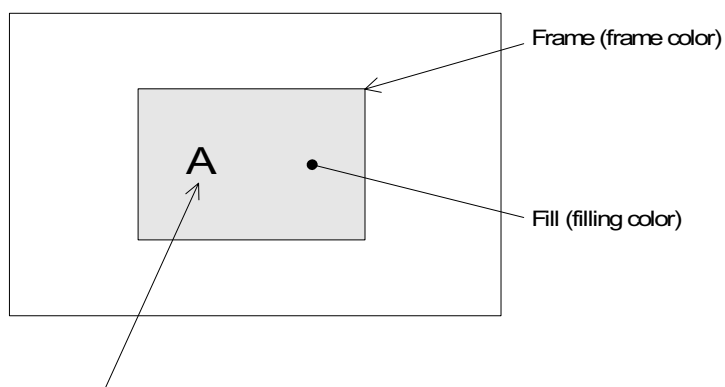

- When a "Text" or "Number" object is combined, fill the box at first, then create an object to be displayed on it. If the "Filled Box" object is created later, the text or the number is hidden under it.
- Quadrangles other than the square and the rectangle can not be drawn.

■Important point

- Filling of entire screen
When the entire screen is to be filled, it is recommended to specify the screen color in the header setting in the screen creation software.

18.4.5 Circle

The "Circle" object displays a circle on the screen.

◆Contents of setting

Attribute	Contents of setting
Position	Enter the X and Y coordinates of the center position in the unit of dot.
Radius	Enter the radius in the unit of dot.
Color (Frame button, Fg button and Bg button)	Enter the display color. (Initial value: Black)

◆Display example

- A circle is displayed in a continuous line.

Example:

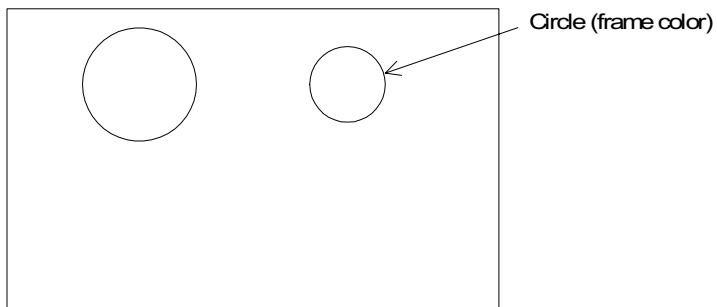

- Use the "Filled Circle" object to display a circle whose inside is filled.

18.4.6 Filled Circle

The "Filled Circle" object displays a filled circle on the screen.

◆Contents of setting

Attribute	Contents of setting
Position	Enter the X and Y coordinates of the center in the unit of dot.
Radius	Enter the radius in the unit of dot.
Color (Frame button and Fill button)	Enter the circle color and the filling color. (Initial values: Black and white)

◆Display example

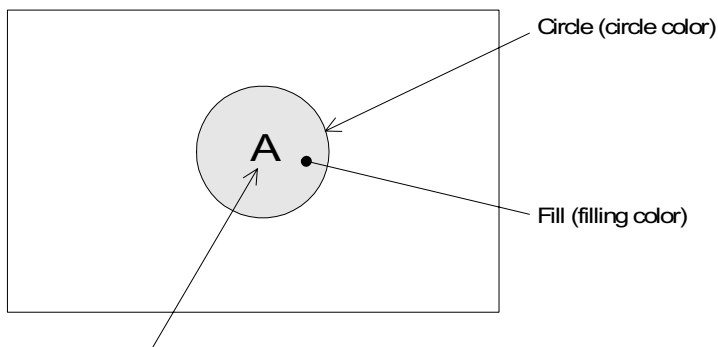

- When a "Text" or "Number" object is combined, fill the circle at first, then create an object to be displayed on it. If the "Filled Circle" object is created later, the text or the number is hidden under it.

18.4.7 Image

The "Image" object displays an image set in the image library on the screen.

◆Contents of setting

Attribute	Contents of setting
Position	Enter the X and Y coordinates of the start point in the unit of dot.
Bg and Fg	Enter the background color and the image color. (Initial values: White and black)
No.	Enter the No. of an image in the image library to be displayed.

◆Display example

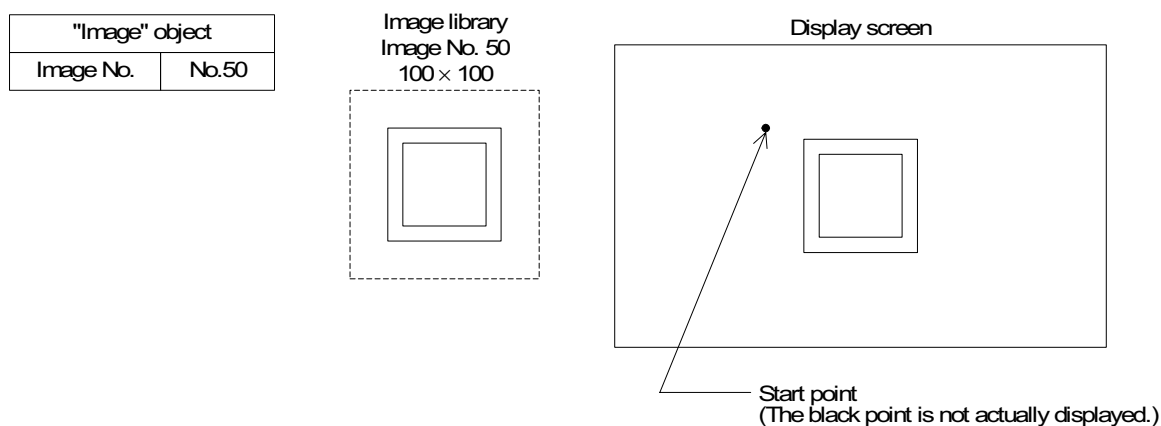

- The selected image stored in the library (described in Section 17.8) is displayed from the specified start point.
- The image is displayed in the same size as that of are stored in the library.
- Images can be registered to the image library using the screen creation software.

18.4.8 Date and time

The "Date/Time" object displays the year, month, day, day of the week and time on the screen. In the F920GOT-K, clock data of the PLC is displayed.

This function can be used only when connected to the FX Series PLC equipped with a clock function or either a memory cassette or memory board.

◆Contents of setting

Attribute	Contents of setting
Position	Enter the X and Y coordinates in the unit of dot.
Bg and Text	Enter the background color and the text color. (Initial values: White and black)
Character Size	Enter the width (W) and the height (H) of characters. The available sizes are ×0.5, ×1, ×2, ×3 and ×4.
Format	Select the display format.
Frame	Select the display frame. (Initial value: No frame)
Frame Color	Enter the display frame color. The area inside the frame is filled with the background color.

◆Display example

Date

Standard European format :31/DEC/1998(THU)

Short European format :31/DEC/1998

Standard USA format :DEC/31/1998(THU)

Short USA format :DEC/31/1998

Time

Standard English format :12:00:30

Short English format :12:00

■Important point

- Displayed date and time
The date and the time set in the system settings in the GOT main body are displayed. (In the F920GOT-K, clock data of the PLC is displayed.)

18.5 Data display objects

This section describes in details the data display objects which show the contents of devices in the PLC.

18.5.1 Library Text

The "Library Text" objects displays text stored in the text library in accordance with the current value or the set value of a word device (T, C, D, V or Z).





As two or more texts can be displayed on one screen, the number of screens can be saved.

◆ Contents of setting

Attribute	Contents of setting
Position	Enter the X and Y coordinates in the unit of dot.
Bg and Text	Enter the background color and the text color. (Initial values: White and black)
Character Size	Enter the width (W) and the height (H) of characters. The available sizes are $\times 0.5$, $\times 1$, $\times 2$, $\times 3$ and $\times 4$.
Word Device	Enter a word device in the PLC which stores the text No. to be displayed. Enter "Data Size" and "Displayed Value (Current or Preset)" also.
Start No.	The monitor value plus this start No. is regarded as the text No.
Frame	Select the frame to be displayed around the text. (Initial setting: No frame)
Frame Color	Enter the frame color. The area inside the frame is filled with the background color.

← 1)

1) Frame: Displayed around the text

Display form				
	No frame	Single frame	Double frame (keyboard)	Double frame (trimming)

◆Display example

- The displayed text is changed in accordance with the ON/OFF status of the limit switches L1 to L3 provided in the carrying line shown below.

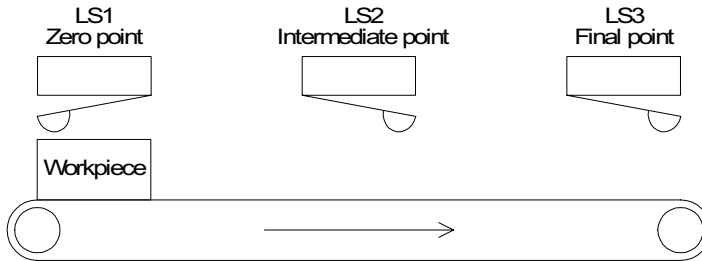

- The "Library Text" object is used in this example. To specify a text No. stored in the library, the data register D10 is used.

- Library Text
 Word Device : D10
 Data Size : 16 bits
 Displayed Value : Current

- Text library
 0
 ⋮
 20 Zero point
 21 Intermediate point
 22 Finished
 ⋮
 ↑
 Text No.

- Program in PLC

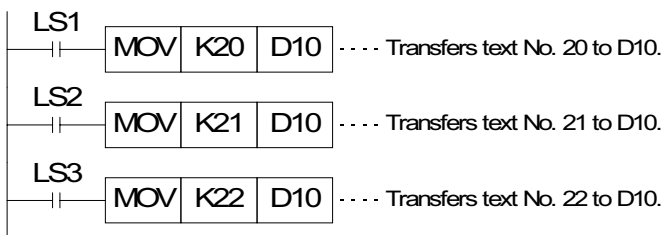

- Display in GOT

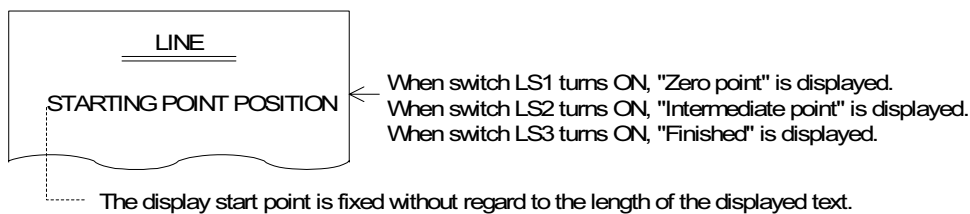

18.5.2 Number

The "Number" object displays the data stored in a PLC word device.

◆ Contents of setting

Attribute	Contents of setting	
Position	Enter the X and Y coordinates in the unit of dot.	
Bg and Fg	Enter the background color and numeric color. (Initial values: White and black)	
Character Size	Enter the width (W) and height (H) of characters. Available sizes are $\times 0.5$, $\times 1$, $\times 2$, $\times 3$ and $\times 4$.	
Digits and Decimal Point At	Enter the total number of digits. Enter the number of digits after a decimal point.	← 1)
Format String	Set the numerical display format. (Initial value: None)	← 2)
Word Device	Enter a word device whose data is to be displayed as a numeric. Enter "Data Size" and "Displayed value (Current or Preset)" also.	
Format	Select a numeric format from "Decimal (with/without sign)", "Hexadecimal", "Octal", "Binary" and "Real". Zero Suppress can be specified.	← 3)
Layout	Select the layout among "Right", "Center" and "Left".	← 4)
Gain 1, Gain 2 and Offset	(Monitor value \times Gain 1 / Gain 2) + Offset The result of this arithmetic operation is displayed.	← 5)
Data Changeable	Set whether or not the data of the specified device can be changed using the keys.	← 6)
Minimum Value and Maximum Value	Set the lower limit and the upper limit of a numeric which can be entered to a word device while "Data Changeable" is made effective with a check mark. Select "Direct" (to enter a desired value) or "Indirect" (to enter a desired data register).	← 7)
User ID and Next ID	These attributes are effective while "Data Changeable" is made effective with a check mark. Enter an object to be displayed next when a cursor control key is pressed.	← 8)
Frame	Select the frame to be displayed around the numeric. (Initial setting: No frame)	
Frame Color	Enter the frame color. The area inside the frame is filled with the background color.	

1) Digits

- Maximum allowable number of digits: 12 ("-" (minus sign) and a decimal point are counted as digits.)

Example:

High-speed counter		C235 (32 bits)
-2147483648	to	2147483648
11 digits		10 digits

If data whose number of digits exceeds the maximum allowable number of digits is specified to be displayed, "?" is displayed.

Number of digits after decimal point (Decimal Point At)

- Enter the number of digits after a decimal point for a case where a decimal point is displayed.

Example: When the displayed numeric is "2000"

2000: Decimal Point At = 0 20.00: Decimal Point At = 2
 200.0: Decimal Point At = 1 2.000: Decimal Point At = 3

Install the touch key which allocates key code (002E) when you input the decimal point by the numeric input operation. (Refer to 7.5.2 for details.)

2) Format String

When the display format is set, a numeric is displayed as follows.

A half-width character "#" in the specified format is replaced with a numeric in actual display.

Characters except "#" are displayed as they are.

Example: ##.##ms → A numeric of three digits is displayed. 12.3ms

The number of "#" in the specified format is regarded as the total number of digits, and the number of digit after decimal point is regarded as "0".

3) Format

- Decimal Number (with/without sign), Hexadecimal Number, Octal Number, Binary Number and Real Number

- Zero Suppress can be specified. When it is specified, "0" is displayed in upper digits up to the specified total number of digits.

Example:

When the total number of digits is set to 7 and the number of digits after decimal point is set to 2

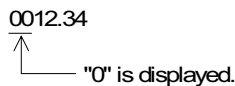

- A numeric is displayed horizontally.

4) Layout

- When the number of digits of a numeric to be displayed is smaller than the value set to "Digits", the numeric is automatically shifted to the position set here.

Example: When "Digits" is set to "9" and the displayed numeric has 3 digits

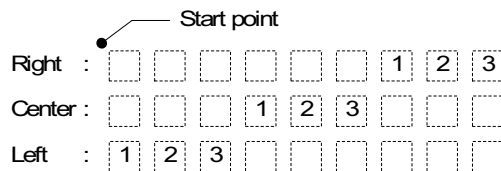

5) Gain 1, Gain 2 and Offset

The value obtained by the calculation "(Monitor value × Gain 1 / Gain 2) + Offset" is displayed.

Example: When the monitor value is 1000 (current value of D100), Gain 1 is set to 10, Gain 2 is set to 2 and Offset is set to 3

$(1000 \times 10 / 2) + 3 = "5003"$ is displayed.

When a numeric is entered (Refer to Chapter 7.), the result of the following arithmetic operation is stored in the specified word device.

$(\text{Input value} - \text{Offset}) / \text{Gain 1} \times \text{Gain 2}$

6) Data Changeable

- When this attribute is made effective (with a check mark), data can be changed if the "Increment", "Decrement", "Data Setting" or "Keyboard" object is combined.
- For the operating procedure, refer to Section 7.5.

7) Minimum Value and Maximum Value

Specify the input range adopted when "Data Changeable" is made effective.

8) User ID

A serial number is automatically assigned to each registered "Number" object in the order of registration.

By checking this number, the changed "Number" object can be detected.

When input is completed, the user ID number of the changed "Number" object is stored in the control device "DO+7".

9) Next ID

This attribute allows to specify the change order of "Number" objects.

By entering the user ID number., the change order can be arbitrarily specified.

Remove the check on [Window] → [Auto User ID & Next ID] when changing "User ID" and "Next ID".

◆ Display example

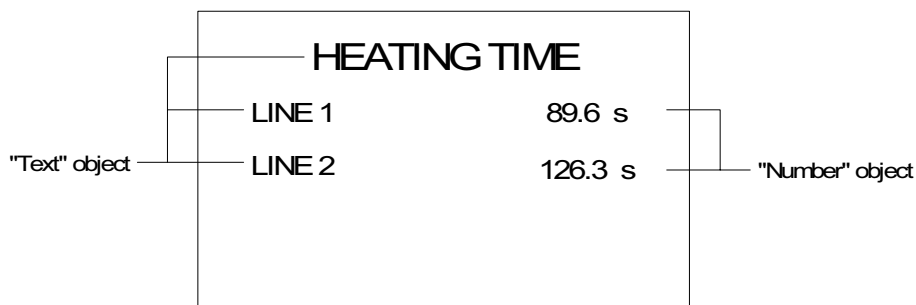

18.5.3 Bar Graph

The "Bar Graph" object displays the value of a specified word device in the PLC. A numeric which is rather difficult to understand in the form of number can be displayed in the form of bar graph so that it can be easily understood at a glance.

◆Contents of setting

Attribute	Contents of setting	
Position	Enter the X and Y coordinates in the unit of dot.	
Size	Enter the width (W) and the height (H) of the bar graph in the unit of dot. The allowable minimum value is 8 W x 16 H.	
Bg and Fg	Enter the background color and the display color. (Initial values: White and black)	
Graph Type	Select the graph type among "Right" (left to right), "Up" (bottom to top), "Left" (right to left) and "Down" (top to bottom).	←1)
Word Device	Enter a word device whose value is to be displayed in the bar graph. Enter "Data Size" and "Displayed value (Current or Preset)" also.	
Minimum Value and Maximum Value	Enter the minimum value (0%) and the maximum value (100%) of the data. "Direct" (to enter a value directly) or "Indirect" (to enter a data register) can be selected.	←1)
Ticks	Enter the number of ticks on the scale attached to the bar graph.	←2)
Scale Position	Select the position among "Right", "Up", "Down" and "Left".	←2)
Frame	Select the frame displayed around the bar graph. (Initial value: No frame)	
Frame Color	Enter the frame color. The area inside the frame is filled with the background color.	

1) Graph Type

- Bar graph type
Right (left to right)Up (bottom to top)
Left (right to left)Down (top to bottom)
- The value entered to "Minimum Value" is regarded as the 0% value. The value entered to "Maximum Value" is regarded as the 100% value. The value of the specified word device is represented in %.
If the value of the specified word device is outside the range specified by "Minimum Value" and "Maximum Value", a diagonal line is drawn in the bar graph.

Example:

Word Device: D1
 Minimum Value: 1000
 Maximum Value: 3000

Graph Type: Right (left to right)

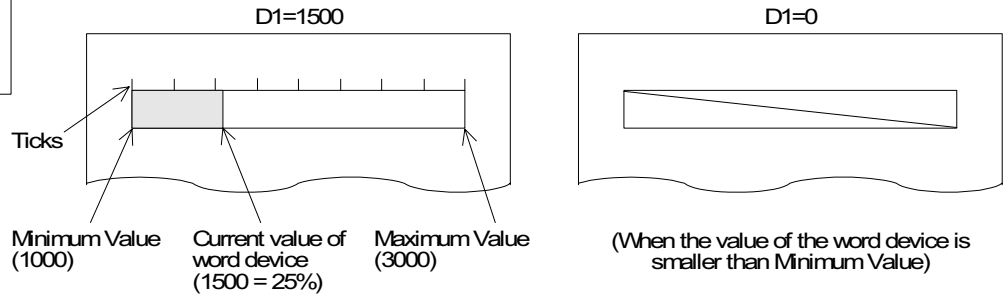

Graph Type: Up (bottom to top)

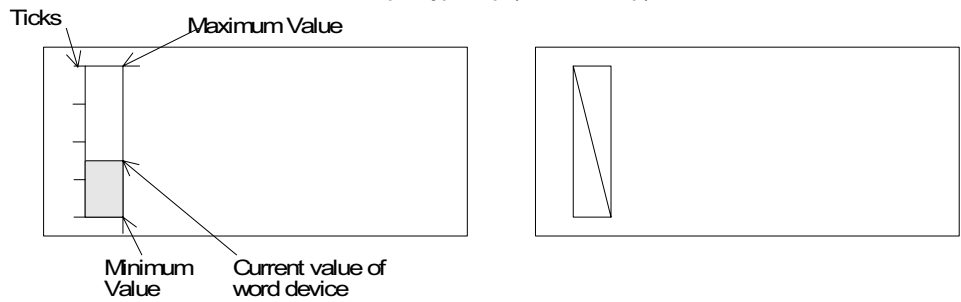

In the case of "Left" (right to left) or "Down" (bottom to top), the "Maximum Value" position and the "Minimum Value" position is exchanged each other from the positions shown above.

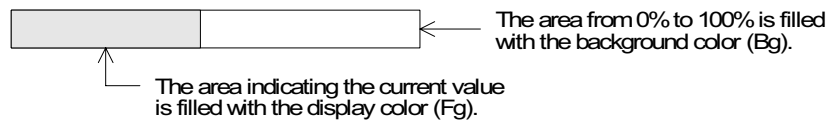

2) Ticks and Scale Position

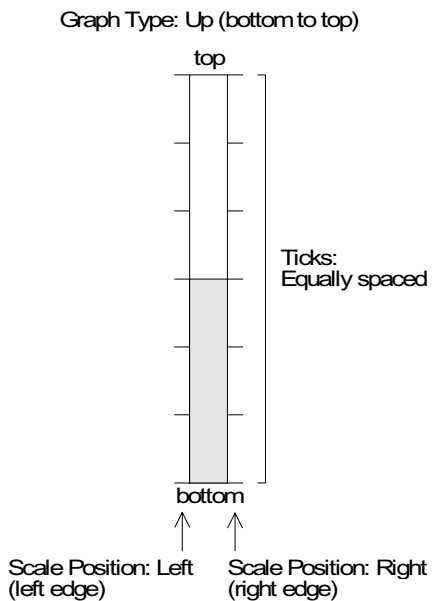
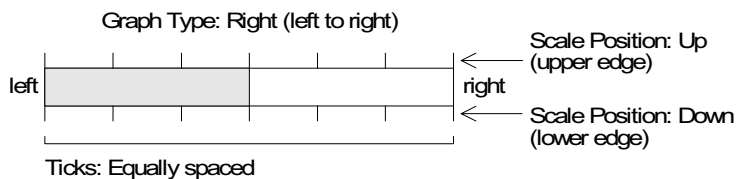

◆ Display example

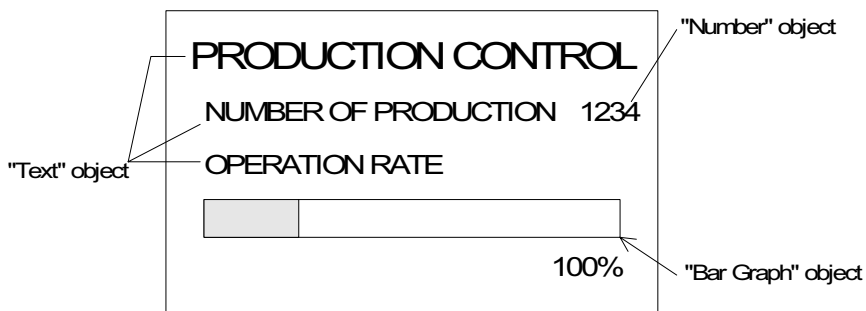

18.5.4 Circle Graph

The "Circle Graph" object displays the current value or the set value of a specified word device in the PLC.

◆ Contents of setting

Attribute	Contents of setting
Position	Enter the X and Y coordinates of the center in the unit of dot.
Radius	Enter the radius in the unit of dot. The allowable minimum value is 16 dots.
Bg and Fg	Enter the background color and the display color. (Initial values: White and black)
Start Position	Select the start position among "Top", "Right", "Bottom" and "Left".
Direction	Select "Clockwise" or "Counterclockwise".
Word Device	Enter a word device whose value is to be displayed. Enter "Data Size" and "Displayed value (Current or Preset)" also.
Minimum Value and Maximum Value	Enter the minimum value (0%) and the maximum value (100%) of the data. "Direct" (to enter a value directly) or "Indirect" (to enter a data register) can be selected.
Ticks	Enter the number of ticks for the scale.
Frame	Select the frame displayed around the graph. (Initial value: No frame)
Frame Color	Enter the frame color. The area inside the frame is filled with the background color.

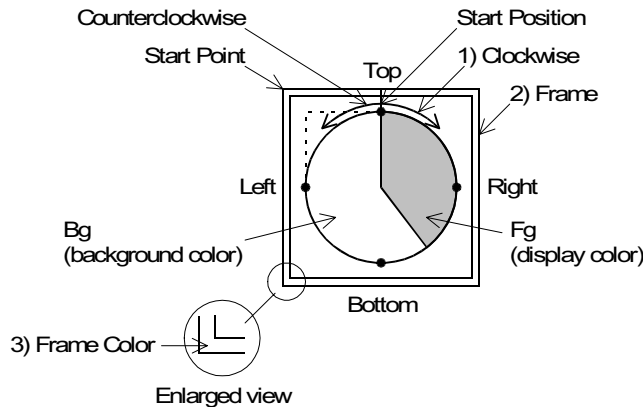

◆ Display example

When "Start Position" is set to "Top" and "Direction" is set to "Clockwise"

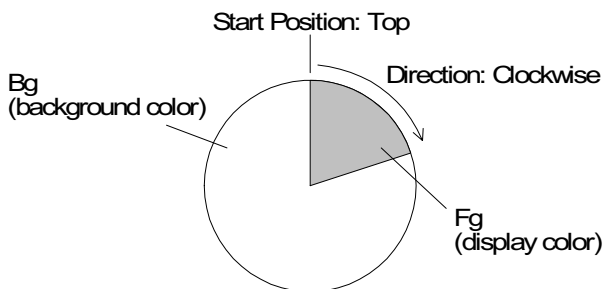

18.5.5 Proportional Bar Graph

The "Proportional Bar Graph" object displays the current value of specified word devices as a ratio against 100%. (Unavailable in the F920GOT-K)

◆Contents of setting

Attribute	Contents of setting	
Position	Enter the X and Y coordinates in the unit of dot.	
Size	Enter the width (W) and the height (H) of the bar graph in the unit of dot.	
Graph Type	Select the graph type between "Vertical" and "Horizontal".	
Word Device	Enter the top word device in the PLC from which consecutive devices are to be displayed. Enter "Data Size" also.	← 1)
Nbr Of Devices	Enter a numeric from 1 to 8 as the number of word devices to be displayed.	← 1)
Bar 1, Bar 2, Bar 3, Bar 4, Bar 5, Bar 6, Bar 7, Bar 8 and Bar Frame	Enter the display color of each data and the bar frame color.	← 2)
Ticks	Enter the number of ticks on the scale graph.	← 3)
Frame	Select the frame displayed. (Initial value: No frame)	← 4)
Frame Color	Enter the frame color. The area inside the frame is filled with the background color.	← 4)

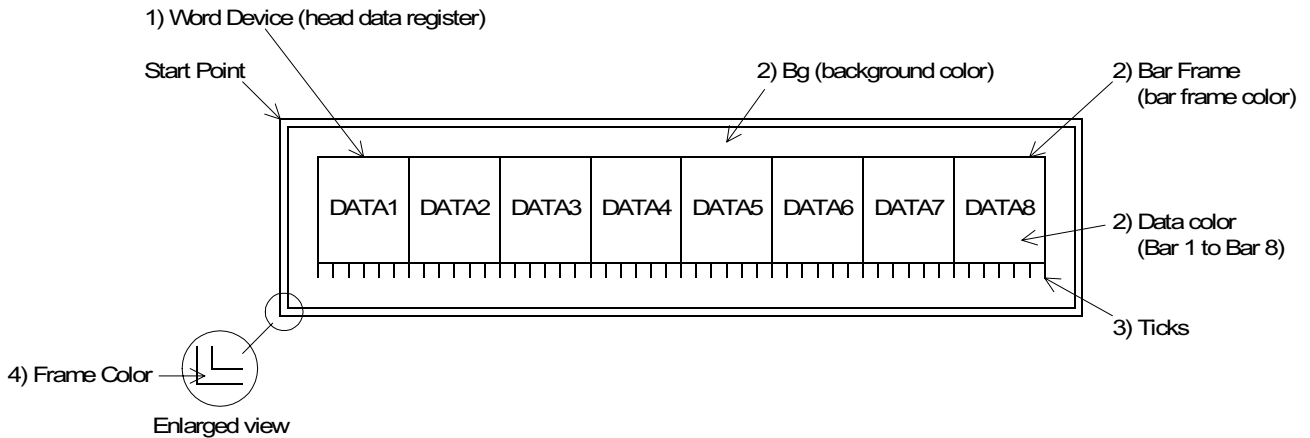

◆Display example

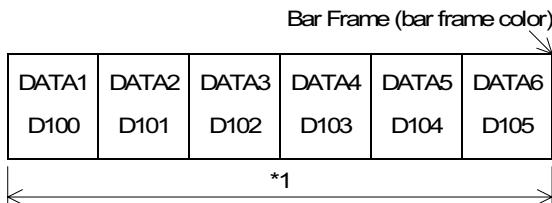

Setting example:
 Word Device: D100
 Number Of Devices: 6

*1 The display size in the horizontal direction is regarded as 100%. The ratio of each data against 100% is represented.

18.5.6 Proportional Pie Graph

The "Proportional Pie Graph" object displays the current value of specified word devices as a ratio against 100% (= 360°). (Unavailable in the F920GOT-K)

◆ Contents of setting

Attribute	Contents of setting
Position	Enter the X and Y coordinates of the center in the unit of dot.
Radius	Enter the radius in the unit of dot.
Word Device	Enter the top word device from which the specified number of consecutive devices are displayed. Enter "Data Size" also. ← 1)
Nbr Of Devices	Enter a numeric from 1 to 8 as the number of word devices to be displayed. ← 1)
Pie 1, Pie 2, Pie 3, Pie 4, Pie 5, Pie 6, Pie 7, Pie 8 and Circle	Enter the display color of each data and the circle frame. ← 2)
Ticks	Enter the number of ticks of the scale.
Frame	Select the frame displayed. (Initial value: No frame) ← 3)
Frame Color, Background (Bg) Color	Enter the frame color. The area inside the frame is filled with the background color. ← 3)

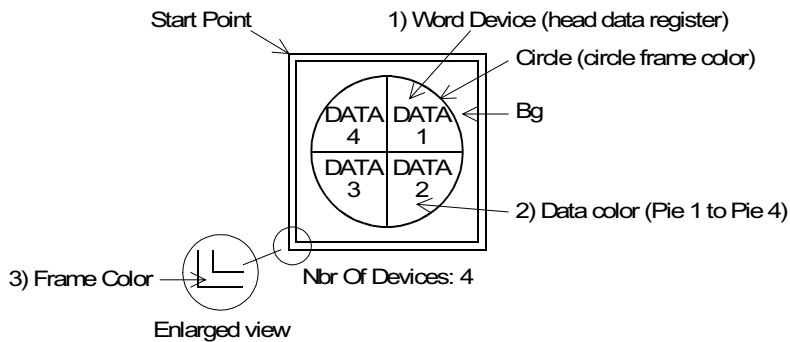

◆ Display example

Setting example:

Word Device: D200

Number Of Devices: 3

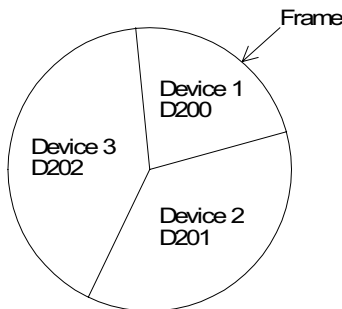

A point located at the top of the circle is regarded as the start point. From the device 1 (D200 in this example), each device is displayed clockwise. "360°" is regarded as 100%. The ratio of the current value of each device against 100% is represented.

18.5.7 Panel Meter

The "Panel Meter" object displays the value of a specified word device.

◆Contents of setting

Attribute	Contents of setting	
Position	Enter the X and Y coordinates in the unit of dot.	
Size	Enter the width (W) and the height (H) in the unit of dot. The "vertical:horizontal" ratio is fixed to "3:4".	
Bg and Fg	Enter the background color and the display color. (Initial values: White and black)	← 1)
Needle	Enter the needle color.	← 2)
Word Device	Enter a word device whose value is to be displayed. Enter "Data Size" and "Displayed value (Current or Preset)" also.	
Minimum Value and Maximum Value	Enter the minimum value (0%) and the maximum value (100%). "Direct" (to enter a direct value) or "Indirect" (to enter a data register) can be selected.	
Ticks	Enter the number of ticks of the scale within the range of 2 to 11.	← 3)
Frame	Enter the frame displayed around the panel meter. (Initial setting: No frame)	← 4)
Frame Color	Enter the frame color. The area inside the frame is filled with the background color.	← 4)

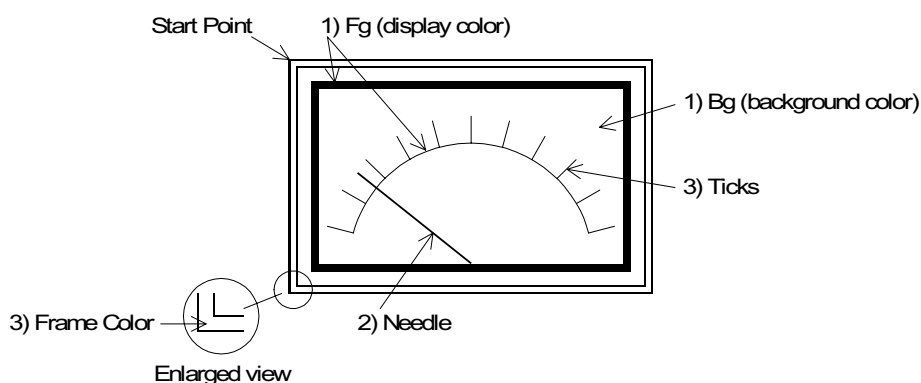

◆Display example

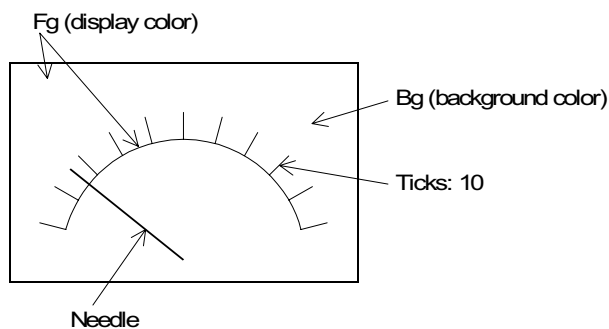

18.5.8 Indicator

The "Indicator" object exchanges the display color and the background color within in the specified area on the screen in accordance with the ON/OFF status of a specified bit device.

◆Contents of setting

Attribute	Contents of setting
Position	Enter the X and Y coordinates in the unit of dot.
Size	Enter the width (W) and the height (H) in the unit of dot.
Color 1 and Color 2	Enter the colors to be exchanged. (Initial values: Black and white)
Bit Device	Enter a bit device to be referred to (positive logic or negative logic).

◆Display example

- When any object is not located within the area specified for the "Indicator" object

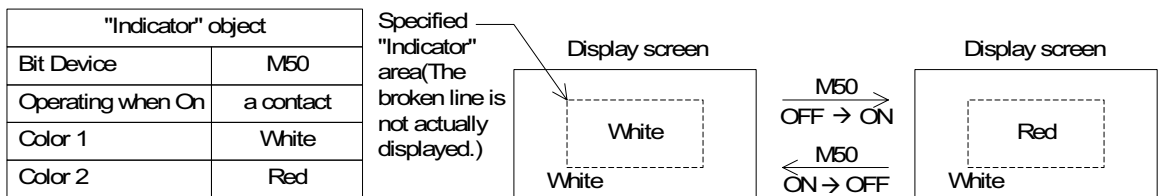

- When M50 becomes ON (a contact), the color of the specified area is changed between color 1 and color 2 of the "Indicator" object.

- When an object is located within the area specified for the "Indicator" object

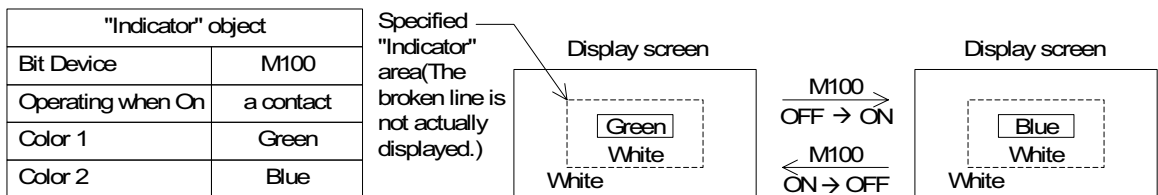

- When M100 becomes ON (a contact), the color of the specified area is changed between color 1 and color 2 of the "Indicator" object.
- Even within the specified area, any color other than green and blue is not exchanged.

- When an object is located within the area specified for the "Indicator" object

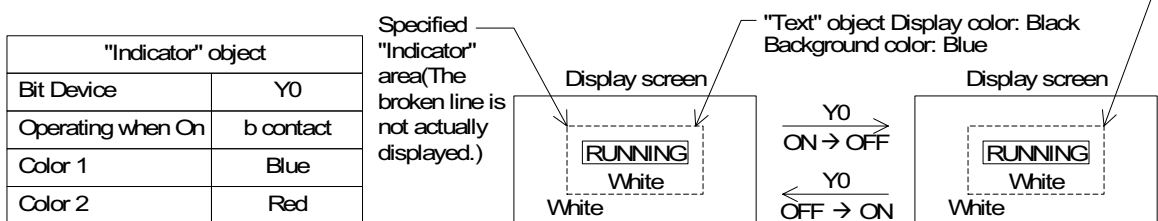

- When Y0 becomes OFF (b contact), the color within the specified area is changed between color 1 and color 2 of the "Indicator" object.
- In the example above, the display color of the "Text" object is black, so is not exchanged. The background color of the "Text" object is blue. In this case, this background color is exchanged between blue and red. The background color is red while Y0 is OFF, and blue while Y0 is ON.

■Important point

- Create the "Indicator" object so that it is located at the top in the display. (Create an object whose color is to be exchanged at first, then create the "Indicator" object.)

18.5.9 Label Indicator

The "Label Indicator" object changes over the displayed image ("Library Image" object) in accordance with the ON/OFF status of a specified bit device.

◆ Contents of setting

Attribute	Contents of setting	
Position	Enter the X and Y coordinates in the unit of dot.	
Size	Enter the width (W) and the height (H) in the unit of dot.	
Bit Device	Enter a bit device to be referred to.	← 1)
Label	Enter a text to be displayed inside the indicator. The character size can be specified.	← 2)
Label Color	Enter the color of the text. (Initial value: Black)	← 3)
Off: Frame and Fill	Enter the indicator frame color and the indicator area color displayed while the specified bit device is OFF. (Initial values: Black and white)	← 4)
On: Frame and Fill	Enter the indicator frame color and the indicator area color displayed while the specified bit device is ON. (Initial values: Black and white)	← 5)
Frame	Select the frame. (Initial value: No frame) The frame is displayed in "Off: Frame" color or "On: Frame" color.	← 6)

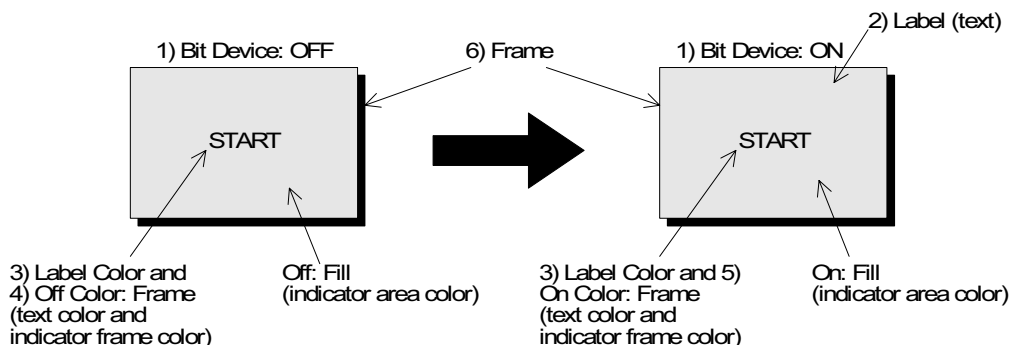

18.5.10 Text Indicator

The "Text Indicator" object changes the displayed text in accordance with the ON/OFF status of a specified bit device (X, Y, M, S, T or C) in the PLC. Texts to be displayed can be entered directly or selected using the text No. stored in the text library.

◆Contents of setting

Attribute	Contents of setting
Position	Enter the X and Y coordinates in the unit of dot.
Bg and Text	Enter the background color and the display color. (Initial values: White and black) The background color can be entered for the ON status and the OFF status respectively.
Character Size	Enter the width (W) and the height (H) of characters. Available sizes are x0.5, x1, x2, x3 and x4.
Bit Device	Enter a bit device to be referred to.
Text Off	Enter a text No. or text itself to be displayed while the specified bit device is OFF.
Text On	Enter a text No. or text itself to be displayed while the specified bit device is ON.
Frame	Select the frame displayed around the text. (Initial setting: No frame)
Frame Color	Enter the frame color. The area inside the frame is filled with the background color.

◆Display example

"Text Indicator" object	
Bit Device	Y0
Text On	10
Text Off	11

- Sequence program

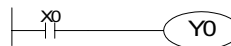

TEXT LIBRARY	
0	CHECK
...	...
9	MOTOR DRIVE
10	DRIVING
11	STOPPING
12	CYLINDER OFF
...	...

Text No.

- GOT screen

While Y0 is ON
Text No. 10 stored in the text library is displayed.

While Y0 is OFF
Text No. 11 stored in the text library is displayed.

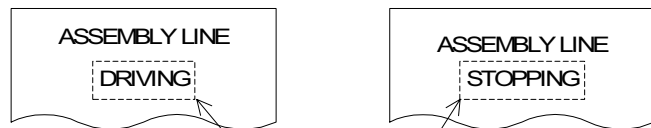

Bg (background color) (The broken line is not actually displayed.)
Text (display color)

"ASSEMBLY LINE" is displayed using the "Text" object.
The displayed text can be changed over on the same screen.

- In the example above, the displayed texts are specified using "text No." stored in the "text library". Instead of this method, text to be displayed while the specified bit device is ON and text to be displayed while the specified bit device is OFF can be entered directly.

18.5.11 Image Indicator

The "Image Indicator" object changes the displayed image in accordance with the ON/OFF status of a bit device (X, Y, M, S, T or C) in the PLC. Images to be displayed can be entered directly or selected using the image No. stored in the image library.

◆Contents of setting

Attribute	Contents of setting
Position	Enter the X and Y coordinates in the unit of dot.
Bg and Fg	Enter the background color and the display color. (Initial values: White and black)
Bit Device	Enter a bit device to be referred to.
Image Off	Enter the image No. of an to be displayed while the specified bit device is OFF.
Image On	Enter the image No. of an to be displayed while the specified bit device is ON.

◆Display example

"Image Indicator" object	
Bit Device	M0
Image On	20
Image Off	30

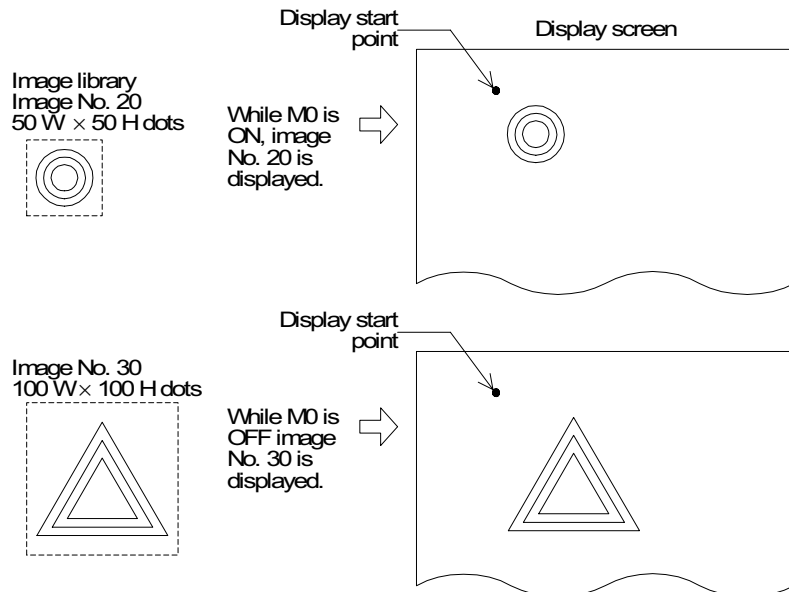

18.5.12 Overlay Screen

The "Overlay Screen" object allows a specified screen to overlay the screen currently displayed while a certain bit device is ON.

◆ Contents of setting

Attribute	Contents of setting
Bit Device	Enter a bit device to be referred to.
Screen No.	Enter a screen No. to overlay the current screen.

◆ Display example

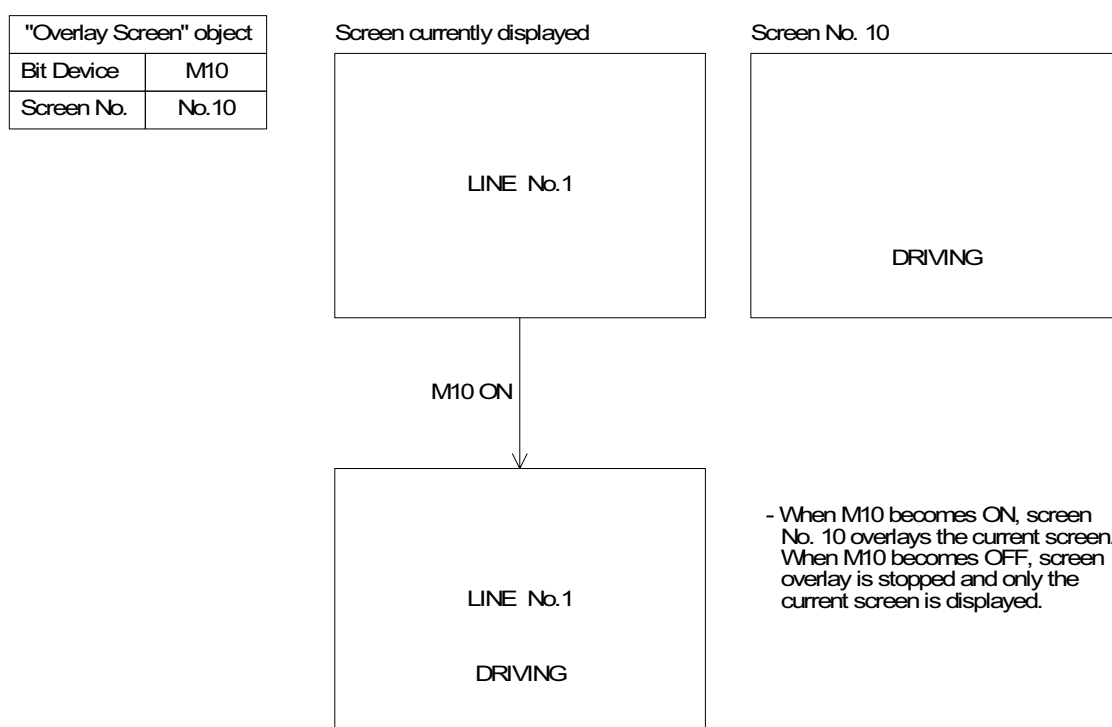

- Up to three screens can be displayed by screen overlay including the current screen. When screen overlay is performed using a control device, screens cannot be overlaid. (Refer to 6.5.3)
- All objects provided on overlaid screens are effective. If touch keys are displayed in a same position, the priority is given to the key on the top screen.

18.5.13 Library Image

The "Library Image" objects displays stored image in accordance with the current value or the set value of a specified word device (T, C, D, V or Z).

As two or more images can be displayed on one screen, the number of screens can be saved.

◆Contents of setting

Attribute	Contents of setting
Position	Enter the X and Y coordinates in the unit of dot.
Bg and Fg	Enter the background color and the display color. (Initial values: White and black)
Word Device	Enter a word device storing an image No. to be displayed. Enter "Data Size" and "Displayed value" (Current of Preset) also.
Start No.	The monitored value plus this start No. are regarded as the image No. of an image to be displayed.

◆Display example

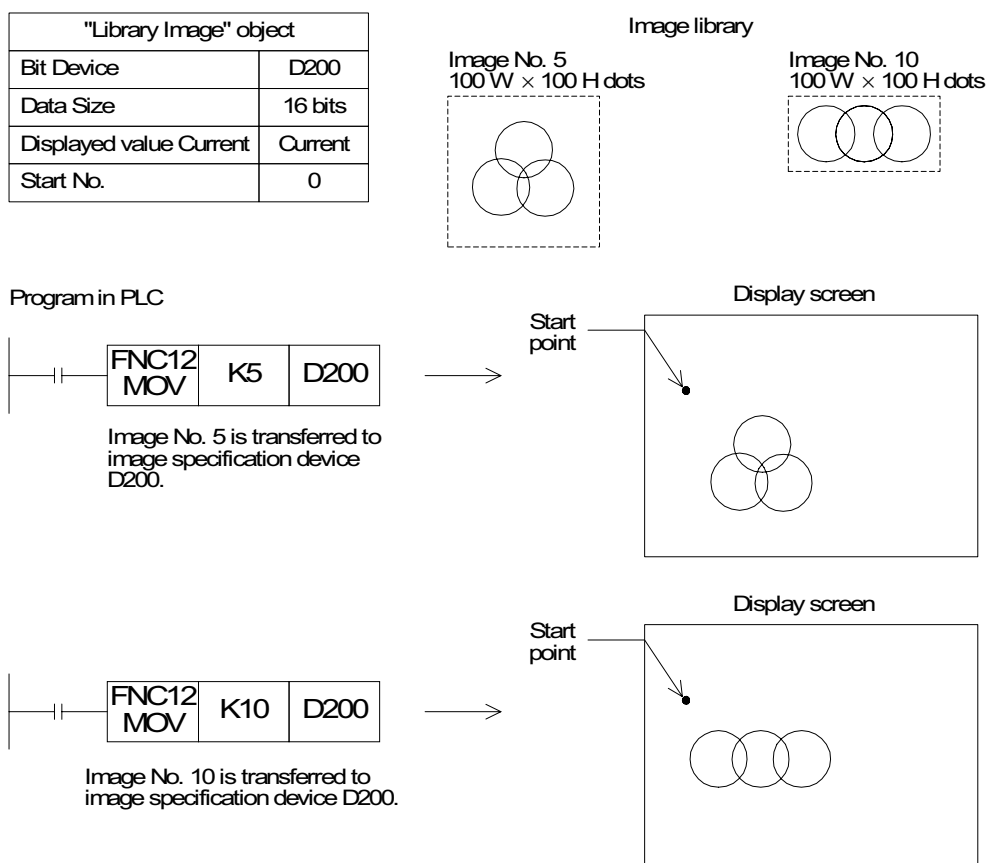

- Image No. 5 or 10 is displayed in accordance with the executed sequence program.
- Both the images are displayed from the same start position.
- Each image is displayed as the same size as stored in the image library.
- In the example above, if "Start No." is set to "10", image No. 15 (5 + 10) and image No. 20 (10 + 10) are displayed.

18.5.14 Trend Graph

The "Trend Graph" object acquires the current value of up to four 16-bit data registers in the PLC at a specified time interval, and displays the acquired values in the form of trend graph. (Unavailable in the F920GOT-K)

◆Contents of setting

Attribute	Contents of setting	
Position	Enter the X and Y coordinates in the unit of dot.	
Size	Enter the width (W) and the height (H) in the unit of dot.	
Scale Color	Enter the scale color. (Initial value: Black)	
Word Device	Enter the head of consecutive word devices to be sampled. Enter "Data Size" also.	
Sampl. Cycle	Enter the sampling cycle within the range of 1 to 65535 seconds.	
Direction	Select "Right" or "Left".	
Shown Devices	Enter the line type and the line color indicating four word devices.	←3)
Ticks Horizontal	Enter the number of ticks of the scale in the horizontal direction within the range of 2 to 50. Same number as sampling points to be displayed.	←1)
Ticks Vertical	Enter the number of ticks on the scale in the vertical direction within the range of 2 to 50.	←1)
Minimum Value and Maximum Value	Enter the minimum value (0%) and the maximum value (100%) of the graph. "Direct" (to enter a value directly) or "Indirect" (to enter a device) can be selected.	←2)
Save Result in Memory	Set whether or not the sampling result is to be saved in the memory. Sampling is continued even if the display screen is changed over.	
Clear Trigger	Enter a bit device which clears the data saved in the memory (None/OFF/ON). In the sampling cycle, the GOT reads the bit device set in "Clear Trigger". Let the bit device set in "Clear Trigger" be ON and OFF in a longer period than the sampling cycle.	
Frame	Select the frame displayed around the trend graph. (Initial setting: No frame)	←4)
Frame Color	Enter the frame color. The area inside the frame is filled with the background color.	←4)

1) Ticks

- Enter the number of ticks on the scale in the horizontal and vertical directions respectively. The available range is 2 to 10 in both directions.

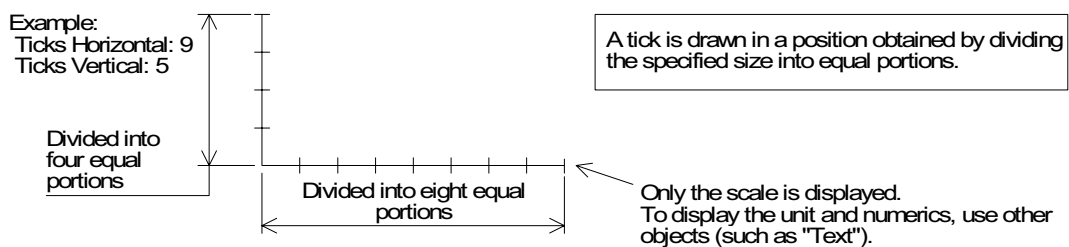

2) Minimum Value and Maximum Value

- Set the sampling data range to be displayed in the vertical axis.

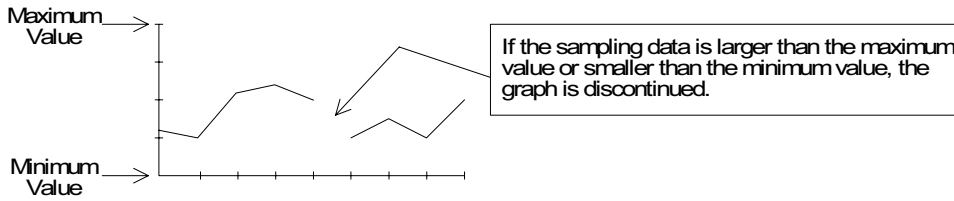

3) Shown Devices

- Select the line type for each trend graph.
- Select the line type for four data registers starting from the one specified in "Word Device".
 - None : Trend graph is not displayed. (Sampling is performed.)
 - Unbroken : Trend graph is displayed in continuous line (—————).
 - Broken : Trend graph is displayed in broken line (- - - - -).
 - Dotted : Trend graph is displayed in dotted line (· · · · ·).
 - Dashed : Trend graph is displayed in alternate long and short dash line (— · — · —).
- A desired color can be assigned to each line.

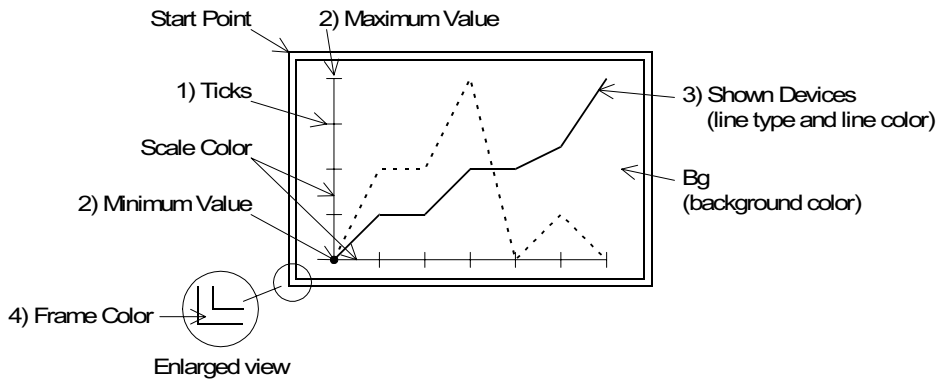

◆Display example

"Trend Graph" object		
Word Device	D100	
Sampl. Cycle	3	
Ticks Horizontal	10	
Ticks Vertical	7	
Minimum Value	0	
Maximum Value	1000	
Shown Device	No. 1	Unbroken Red
	No. 2	Dotted Blue
	No. 3	None
	No. 4	None
Scale Color: Black		

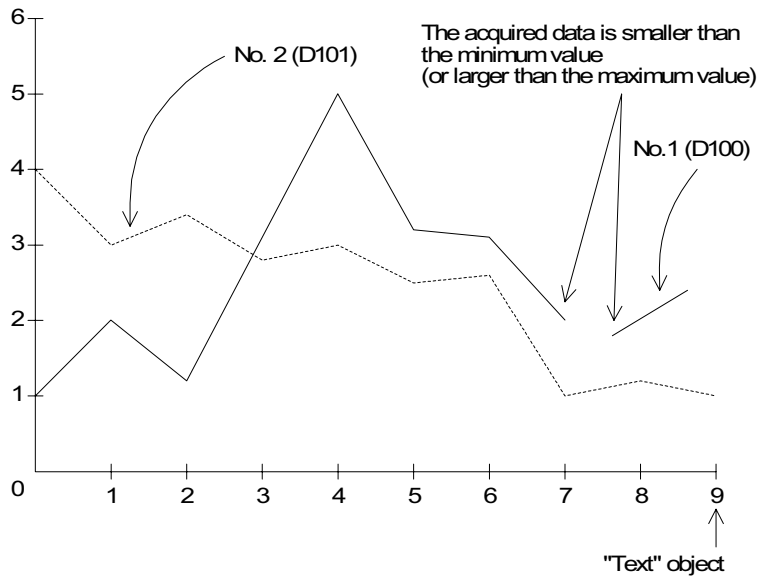

- The word devices D100 and D101 are sampled every 3 seconds, and trend graphs are displayed.
- Numerics 0 to 9 in the scale are created using the "Text" object.
- If the data acquired by sampling is smaller than the minimum value (0) or larger than the maximum value (1000), it is not displayed in the graph and the graph is discontinued.
- When the line type is set to "None", the graph is not displayed on the screen.

18.5.15 Line Graph

The "Line Graph" object displays the current value of consecutive word devices in up to four lines. (Unavailable in the F920GOT-K)

◆Contents of setting

Attribute	Contents of setting	
Position	Enter the X and Y coordinates in the unit of dot.	
Size	Enter the width (W) and the height (H) in the unit of dot.	
Scale Color	Enter the scale color. (Initial value: Black)	
Word Device	Enter the head of consecutive word devices. (The current value is displayed for timers and counters.) Enter "Data Size" also.	←1)
Direction	Select "Right" or "Left".	←4)
Shown Devices	Enter the type and the color of up to four lines.	←4)
Ticks Horizontal	Enter the number of ticks of the scale in the horizontal direction within the range of 2 to 50. Same number as sampling points to be displayed.	←2)
Ticks Vertical	Enter the number of ticks of the scale in the vertical direction within the range of 2 to 50.	←2)
Minimum Value and Maximum Value	Enter the minimum value (0%) and the maximum value (100%) of the graph. "Direct" (to enter a value directly) or "Indirect" (to enter a device) can be selected.	←3)
No Display Value	When the acquired data is equivalent to a value entered here, the acquired data is not displayed.	←5)
Frame	Select the frame displayed around the line graph. (Initial setting: No frame)	
Frame Color	Enter the frame color. The area inside the frame is filled with the background color.	

1) Word Device

Word devices as many as the number of lines multiplied by the number of ticks in the horizontal direction are displayed in the form of line graph.

The number of word devices shown at each tick is equivalent to the number of lines specified in "Shown Devices".

Assignment of word devices to points in line graph

Word device	D	D+1	D+2	D+3	D+4	D+5	D+6	D+7
Data number	No.1	No.2	No.3	No.4	No.1	No.2	No.3	No.4
Tick in horizontal axis	1st tick				2nd tick			

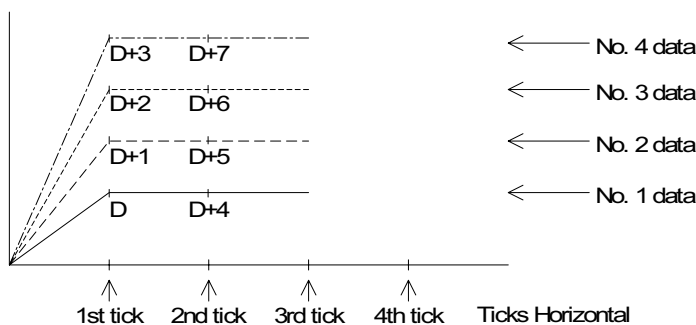

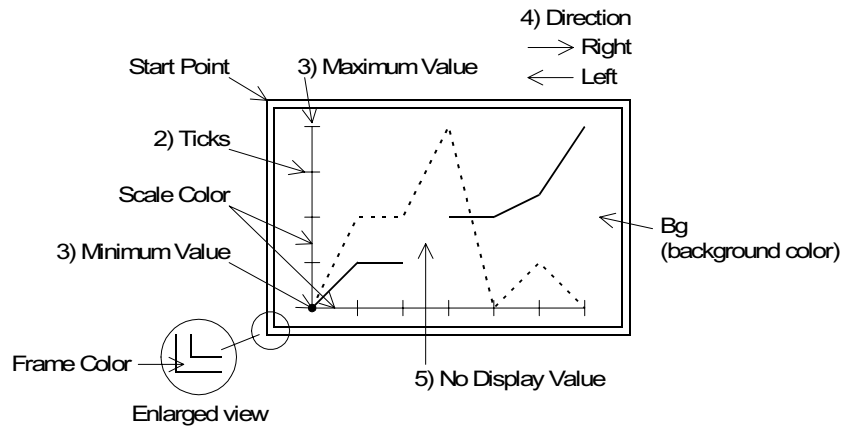

18.5.16 Ascii

The "Ascii" object displays characters corresponding to specified word devices (T, C, D, V or Z). Arbitrary characters can be displayed on one base screen.

◆Contents of setting

Attribute	Contents of setting
Position	Enter the X and Y coordinates in the unit of dot.
Bg and Text	Enter the background color and display color. (Initial values: White and black)
Character Size	Enter the width (W) and the height (H) of characters. Available sizes are × 0.5, × 1, × 2, × 3 and × 4.
Word Device	Enter the head of word devices storing character codes to be displayed.
Data Length	1 word (16 bits) corresponds to two half-width characters. Up to 20 words (= 40 characters) can be displayed. *1 Consecutive devices only can be specified. *2 High-speed counters C200 to C255 occupy 32 bits each, and are regarded as 2 words. The text length shall be up to 20 words.
Data Changeable	Set whether or not the data can be changed using keys.
User ID Next ID	These IDs are effective when "Data Changeable" is made effective. An object to be displayed next when a cursor control key is pressed. Remove the check on [Window] → [Auto User ID & Next ID] when changing "User ID" and "Next ID"
Frame	Select the frame displayed around the characters. (Initial setting: No frame)
Frame Color	Enter the frame color. The area inside the frame is filled with the background color.

Alphabets, numerics, etc. which can be specified using ASCII codes.

◆How to specify character codes

- Reading the ASCII table
This section describes how to read ASCII using the Appendix as an example.
One ASCII character is displayed by combining both the vertical and horizontal axes.
.....The vertical axis shows the last digit of the code.

Example Select "A": Horizontal axis H40 Vertical axis 1 → ASCII H41 (hexadecimal expression)
Select "b": Horizontal axis H60 Vertical axis 2 → ASCII H62 (hexadecimal expression)

Higher Bit Lower Bit	1	2	3	4	5	6	7
0		(SP)	0	@	P	@	p
1		!	1	A	Q	a	q
2		"	2	B	R	b	r
3		#	3	C	S	c	s

◆Storage of word device

- Character codes are stored in PLC word devices. The stored data is displayed from the lower 8 bits as shown below.

Example : When two characters (ASCII codes) are displayed
 Word Device : D0
 Data Length : 1

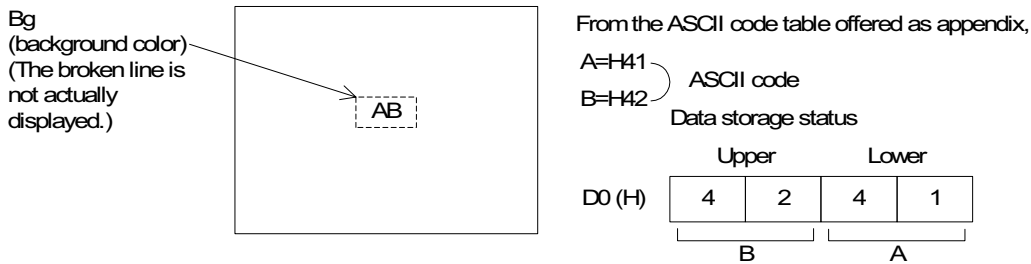

- A character to be displayed at first should be specified using lower 8 bits.

■Important point

- When the character code is set to "H0", characters after that are not displayed on the screen.
 To insert space in a text, store "H20" to the specified word device.
- When connecting with the A Series PLC through a computer link or with the S7-200/300/400 Series from Siemens AG, ASCII codes are displayed from the left of the screen in order of upper eight bits to lower eight bits.
 Only when connecting with the A Series PLC through computer link, ASCII codes can be displayed from the left of the screen in order of lower eight bits to upper eight bits by changing the station number in "View/Project" – "System Settings" – "Setup Data" – "PLC Station No". Add 16 to the actual station number to effect the change. (For example: station # 3 becomes #19.)

◆ Display example

- "NORMAL" or "HIGH!!" are displayed as the "Ascii" objects using three data registers D100 to D102.
 When X0 becomes ON, "NORMAL" is displayed.
 When X1 becomes ON, "HIGH!!" is displayed.
- "Ascii" object
 Character Size: W: x2, H: x2
 Word Device: D100
 Data Length: 3
- Display

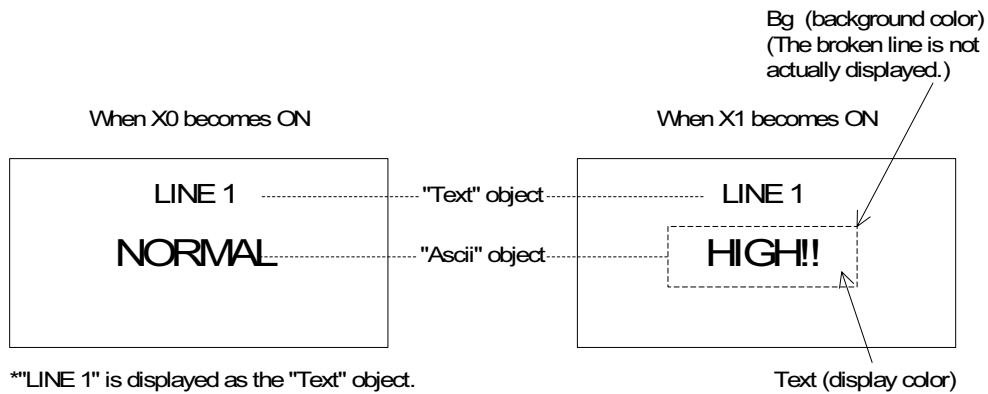

- Program in PLC

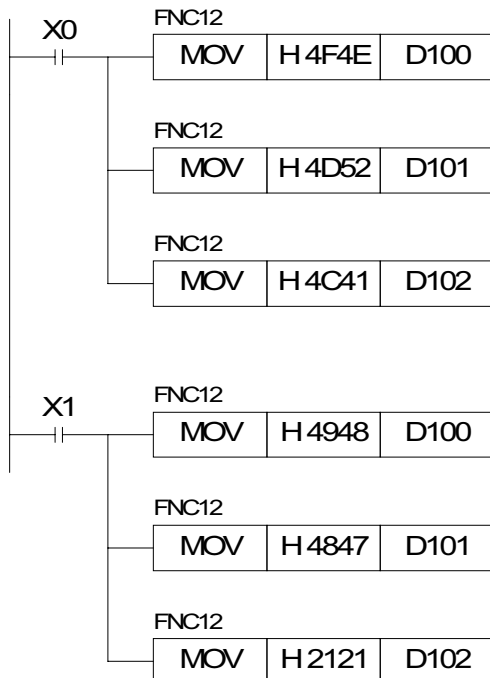

Storage status of data registers

	Upper	Lower	
D100	4F	4E	(H)
D101	4D	52	(H)
D102	4C	41	(H)

Storage status of data registers

	Upper	Lower	
D100	49	48	(H)
D101	48	47	(H)
D102	21	21	(H)

■ Important point

The "Ascii" object displays specified texts on one screen as shown above. Accordingly, the screen is not required to be changed over or to be overlaid.

18.6 Data transfer objects

This section describes in detail the objects which turn on/off bit devices and change word devices in the PLC.

The objects described in this section are combined with touch keys or function keys (F920GOT-K and F930GOT-K) on the screen.

The following functions can be assigned to touch keys or function keys.

- Switch
 - Send Data Bank
 - Write Constant
 - Increment
 - Decrement
 - Data Setting
 - Change Screen
- When assigning the above functions to function keys of F920GOT-K or F930GOT-K, set them for "External key" on the "Keys" window.

18.6.1 Assignment of function keys

When assigning the above functions to function keys of F920GOT-K or F930GOT-K, set them for "External key" on the "Keys" window.

- The functions on function keys can be set for individual screen.
- A key code cannot be assigned to a function key.

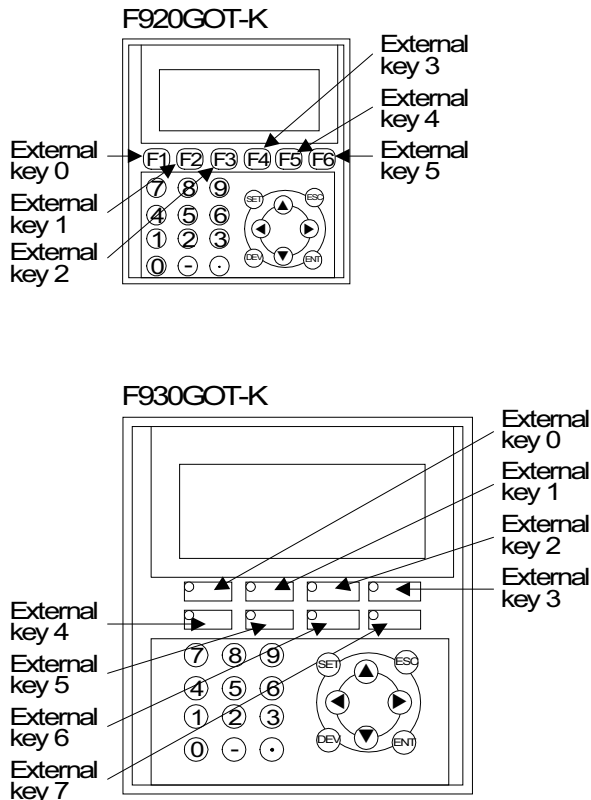

"Keys Scr." display in the FX-PCS-DU/WIN-E

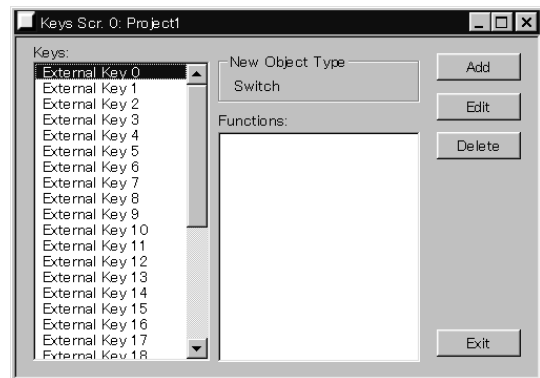

18.6.2 Touch Key

A specified area on the screen can be set as a touch key which functions as an operation key when pressed.

The "Touch Key" object specifies an area which functions as a touch key. To each touch key, functions offered by the objects "Switch", "Send Data Bank", "Write Constant", "Increment", "Decrement", "Data Setting" or "Change Screen" can be assigned.

(Unavailable in the F920GOT-K)

◆Contents of setting

Attribute	Contents of setting	
Position	Enter the X and Y coordinates in the unit of dot.	
Size	Enter the width (W) and the height (H) in the unit of dot.	←1)
Reverse On Touch	Set whether or not the touch key frame is changed when pressed (None/Key/Bit). When "Bit" is selected, specify a bit device for changeover.	←2)
Key Code	Enter a 16-bit hexadecimal value. Used as a code when a character is entered or when a special operation is performed.	←3)
Auto repeat and Simul. press	Set operation.	←4)
Label	Enter text to be displayed inside the touch key. Character size can be specified.	←5)
Label Color	Enter the label color. (Initial value: Black)	←6)
Key Type	Select the touch key frame shape.	
Frame Color	Enter the display color and the background color. (Initial values: Black and white) For the background color, enter colors for the ON and OFF status as respectively.	

1) Display Size (F940GOT)

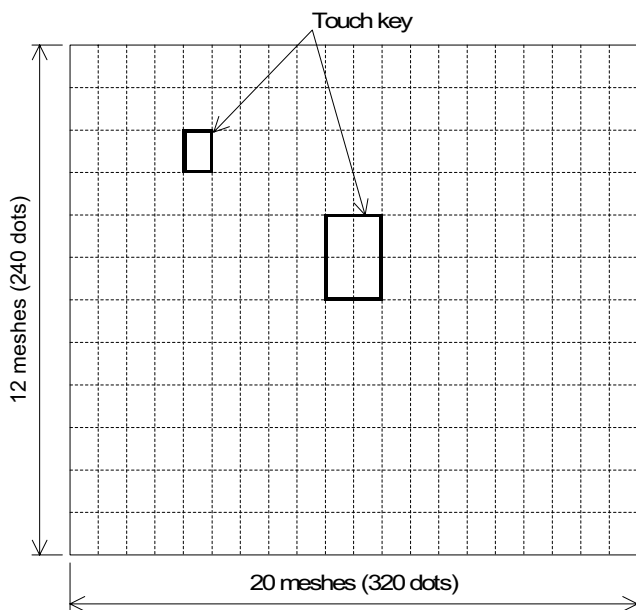

- The entire screen is divided into "meshes" as shown on the left. The touch key area can be specified in the unit of mesh.
- The meshes and matrix configuration of each GOT is as follows.
(One mesh consists of 16 × 20 dots.)
F930GOT, F933GOT:
15 (horizontal) × 4 (vertical)
F940GOT, F943GOT:
20 (horizontal) × 12 (vertical)
F940WGOT:
30 (horizontal) × 12 (vertical)
Last column composed of 14 dots
- Broken lines are not actually displayed on the screen.

- A touch key can be set in the unit of dot. When more than a half of a mesh is set as a touch key, the mesh is recognized as the touch key.

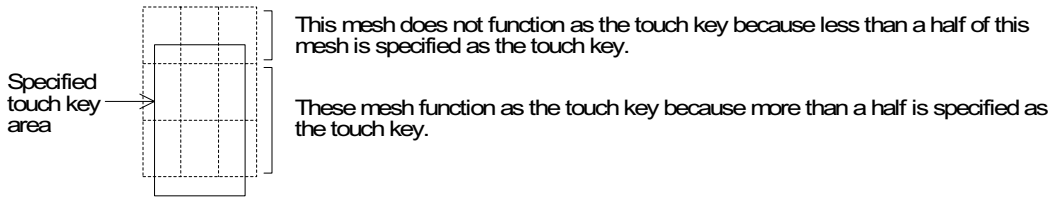

2) Reverse On Touch

When this item is made effective, the touch key is reversed instantaneously when pressed.

3) Key Code

A touch key can be used for a dedicated purpose by inputting a key code.

Except the key code (FFFE) to mute the buzzer sound, a touch key to which a key code is input cannot be used for any other purpose (such as switch, screen changeover and data change).

Key code	Function screen display
FF11	DEVICE MONITOR screen (HPP MODE)
FF12	BFM MONITOR screen (HPP MODE)
FF14	SELECT MODE screen
FF64	SET CLOCK screen (OTHER MODE)
FF68	Entry code registration screen
FF69	Resets the entry code.
FFFE	Mutes the buzzer sound. (Muting can be set for each touch key.) If the buzzer sound is "muted" in the operation environment setting, the buzzer sound is muted for all touch keys on all screens without regard to the setting of the key code (FFFE).

The key code (FFFE) to mute the buzzer sound can be used in the following GOT.

Model	Applicable version
F930GOT, F933GOT	V4.50 and later
F940GOT, F943GOT (including ET and handy GOT)	V6.50 and later
F940WGOT	V1.50 and later

- For other key codes, refer to the appendix.

4) Auto repeat and Simul. press

Auto repeat : Repeats the ON/OFF operation at a constant cycle while the touch key is pressed and held.

Simul. press : Specifies whether or not the touch key is effective when it is pressed simultaneously together with another touch key.

Three or more keys cannot be made effective when pressed simultaneously.

5) Label

Enter text to be displayed inside the touch key.
Up to 40 characters can be displayed.

<Display example>

-In the case of 1 line

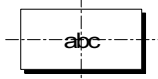

When text is located in the center

-In the case of 2 lines

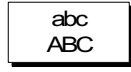

When the first line is blank, text is displayed in the second line

-In the case of 3 lines

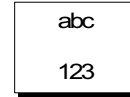
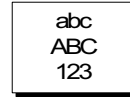

When the second line is blank, texts is displayed in the first and third lines respectively

If text is longer than the touch key, the text is extruded.



When text is displayed in 1 line

6) Key Type Example

- Select whether or not the touch key area is enclosed with a frame.
- Select "No frame" or select one among the following ten frames.
(Five frames for earlier than V2.30)

Frame shape						
	No frame	Shaded	Double frame (keyboard)	Double frame (trimming)	Double frame (shaded)	Double frame (bold)

7) Additional functions

The following functions can be assigned to a touchkey.

Functions	Remarks
<ul style="list-style-type: none"> • Switch (Refer to Section 18.6.2.) • Increment (Refer to Section 18.6.5.) • Decrement (Refer to Section 18.6.6.) • Write Constant (Refer to Section 18.6.4.) 	<ul style="list-style-type: none"> • Two or more of these functions can be set to a touch key.
<ul style="list-style-type: none"> • Send Data Bank (Refer to Section 18.6.3.) • Data Setting (Refer to Section 18.6.7.) 	<ul style="list-style-type: none"> • Only one of these function can be set to a touch key. (The functions above can be combined.)
<ul style="list-style-type: none"> • Change Screen (Refer to Section 18.6.9.) 	<ul style="list-style-type: none"> • When setting two or more of changeover functions to a touch key, set Bit Device to a different pattern.

◆Use example 1

- 1) Relationship between the common setting for all screens and the setting for individual screens

A touch key registered in the common setting is displayed as the same size and same position in any screen.

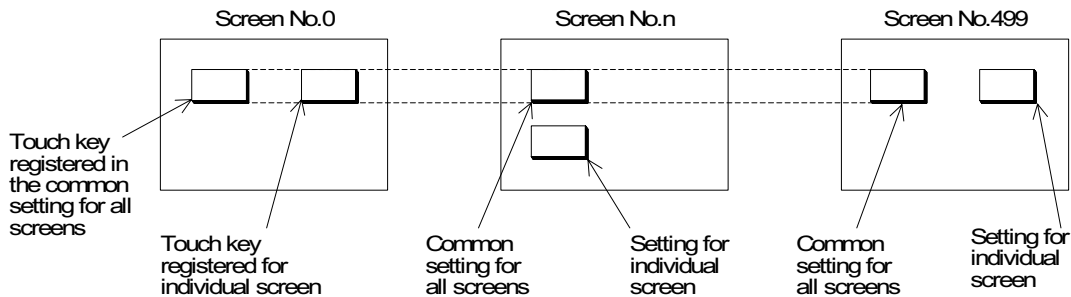

To display a name on a touch key, enter text inside the touch key in "Label".

Note: If a touch key registered in the common setting for all screens and a touch key registered for individual screen are displayed in the same position, the priority is given to the individual screen. Pay close attention in specifying the key area.

◆Use example 2

Example: When "Touch Key" and "Indicator" objects are combined
On the screen, "START" is displayed as the "Text" object.

- 1) When a touch key is pressed, the switch function assigned to the touch key sets Y0 to ON. The output form of Y0 is set to "Alternate".
- 2) The touch key area is inverted by the "Lamp" object so that turning on of the switch can be confirmed.

"Switch" object	
Control Input	Touch Key
Bit Device	Y0
Operation	Alternate

"Indicator" object	
Bit Device	Y0
Operating when	a On
Display color	White
Background color	Black

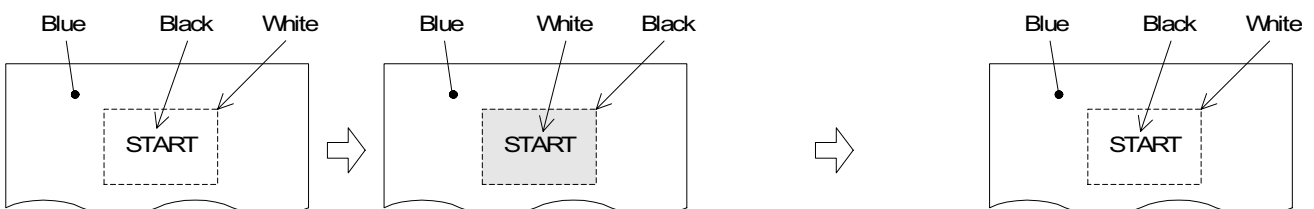

- Press the START touch key.
- The area enclosed with broken line is specified as the "Indicator" object.
- By the switch function assigned to the touch key, Y0 becomes ON. By the indicator function, the touch key color is changed from white into black. Even if the START touch key is released, Y0 remains ON because its output form is alternate, and the indicator remains in the changed status (= white text on black background).
- When the START touch key is pressed again, Y0 becomes OFF and the indicator is returned to the former status (= black text on white background).

18.6.3 Switch

The "Switch" object allows a touch key or function key in the GOT to control the ON/OFF status of a bit device in the PLC.

The "Switch" object offers the switch function as a pushbutton switch, etc.

◆Contents of setting

Attribute	Contents of setting
Control Input	Enter a key name which actuates the switch function.
Bit Device	Enter a bit device to be driven by the key specified in "Control Input".
Operation	Select the operation mode among "Momentary", "Alternate", "Set" and "Reset".

1) Operation

- Select the output operation mode.

Momentary : Turns the controlled bit device ON/OFF in accordance with the ON/OFF status of the control input key.

Alternate : Turns the controlled bit device ON/OFF every time the control input key becomes ON from OFF.

Set : Forces the controlled bit device ON when the control input key becomes ON. The controlled bit device remains ON until a reset input is given.

Reset : Forces the controlled bit device OFF when the control input key becomes ON.

Operation examples of "Momentary" and "Alternate"

When a touch or function key is pressed, Y0 in the PLC is output.

- Switch Control Input: Touch key
Bit Device (output): Y0

When "Operation" is set to "Momentary"

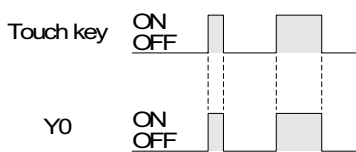

When "Operation" is set to "Alternate"

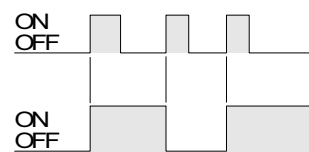

Operation examples of "Set" and "Reset"

When the SET key is pressed, Y1 is set. When the RST key is pressed, Y1 is reset.

- Switch Control Input (key): SET key, RST key
Bit Device (output): Y1 (set), Y1 (reset)

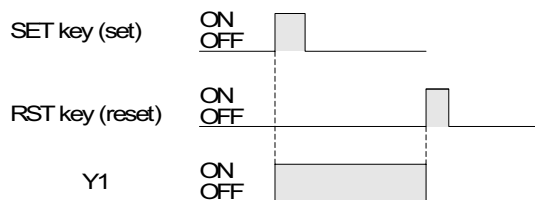

■ Important point

- 1) Controlled bit device:
If "Operation" is set to "Momentary", the controlled bit device becomes OFF when the display screen is changed over.
If the "Switch" object is registered in the common setting for all screens, it is effective on all screens.
- 2) If two or more keys are pressed simultaneously:
If two or more switch functions are registered, and two keys are simultaneously pressed both functions will be executed.
If three or more keys are pressed simultaneously, only the first two pressed will be effective.
- 3) If two or more functions are assigned to one touch key or one function key:
Two or more switch functions can be registered to one touch or function key.
- 4) If screens are overlaid:
If screens are overlaid using control devices, the screen call function or the "Overlay Screen", the switch functions are effective on all of the base screen and the overlaying screens. If switches are overlaid, the switch on the top screen is effective. Pay close attention so that switches do not are not overlaid.

Example

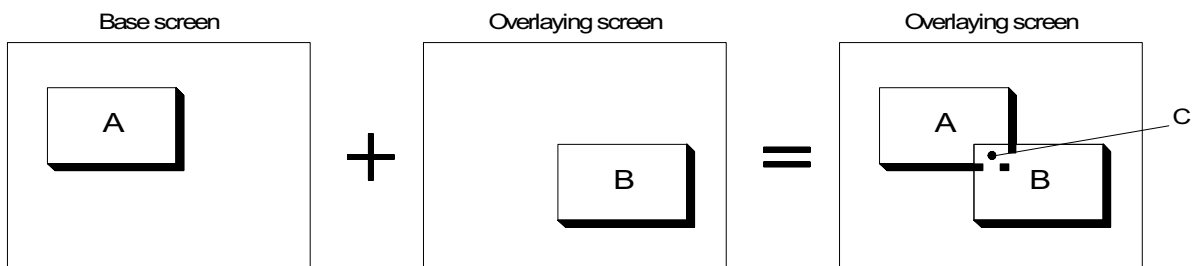

In switch areas A and B on the composed screen realized by overlay, each switch is effective. However, if the area C is pressed, the switch B located on the top is effective.

- 5) Caution on connecting the SYSMAC C Series manufactured by OMRON
Using a forced set/reset by peripheral equipment in the SYSMAC C Series PLC locks the PLC bit devices into their current state. This state cannot be changed by the PLC program. In the above described situation, using the switch function in USER SCREEN MODE or forced ON/OFF function in HPP MODE in the GOT will have the following consequences.
 - a) If a bit device is turned ON/OFF in the GOT, all the bit devices are released to change state by the PLC program. (GOT uses the KC command)
F930GOT or F933GOT: prior to Version 4.40; F940GOT or F943GOT: prior to Version 6.40; F940WGOT: prior to Version 1.40
 - b) Only the device turned ON/OFF in the GOT is released to change state by the PLC program. (GOT uses the FK command)
F930GOT-K: First version, F930GOT or F933GOT: Version 4.40 or later;
F940GOT or F943GOT: Version 6.40 or later; F940WGOT: Version 1.40 or later

18.6.4 Send Data Bank (recipe function)

The GOT can store up to 4,000 16-bit data corresponding to data registers in the PLC. By giving a command via a touch or function key, data can be read from/written to the PLC. For data files, refer to "17.9 Data file".

◆Contents of setting

Attribute	Contents of setting
Control Input	Enter a key which actuates data transfer.
Bank No.	Enter a data file number to be transferred. Select "Direct" or "Indirect".
Function	Select "GOT → PLC" or "PLC → GOT".

- 1) Bank No.
Enter a file No created using the screen creation software (when selecting "Direct").
Or file number can be specified using a control device "D0+6" (when selecting "Indirect").
- 2) Function
Specify the data file transfer direction.
GOT → PLC: Writes data stored in a data file in the GOT to a data register in the PLC.
PLC → GOT: Writes data stored in a data register in the PLC to a data file in the GOT.

■Important point

- Data file transfer condition
"✓" indicates that transfer is enabled.

PLC	FX Series	A Series
PLC memory type	✓:RAM ×:EPROM *1 ×:EEPROM *1 When the read/write destination is a data register, data can be transferred without regard to the memory type.	✓:RAM ✓:EPROM
PLC operation status	✓:RUN ✓:STOP	✓:RUN ✓:STOP
GOT memory type	✓:Flash memory	✓:Flash memory
PLC entry code	×: While entry code is registered (while write is forbidden) ✓: While entry code is unlocked or is not registered	×: While entry code is registered (while write is inhibited) ✓: While entry code is unlocked or is not registered

Do not set two or more "Send Data Bank" functions to one touch or one function key. Even if the above attempt is made, the function registered last overwrites the previous one because the data register number to read from/write to the PLC is fixed for the send data bank function.

18.6.5 Write Constant

The "Write Constant" object writes a fixed constant to the PLC when a touch or function key is pressed.

The "Write Constant" object is convenient: When it is used, sequence programs such as transfer instructions are not required.

◆Contents of setting

Attribute	Contents of setting
Control Input	Enter a key which actuates write of a constant.
Constant	Enter a fixed value to be written to a word device.
Word Device	Enter a word device to which the fixed value is written. Enter "Data Size" and "Changed Value" (Current or Preset) also.

■Important point

1) Write constant to a timer/counter

Even if "0" is written to the current value or set value of a timer/counter, the output contact in the PLC is not reset. (Though the current value or set value becomes 0, the output contact does not become OFF.)

To reset a timer/counter, execute an RST instruction in the sequence program or reset the timer/counter using the switch function.

18.6.6 Increment

The "Increment" object adds "1" to the data of a specified word device when a touch or function key is pressed.

◆Contents of setting

Attribute	Contents of setting
Control Input	Enter a key which actuates increment.
Word Device	Enter a word device to which 1 is added. Enter "Data Size" and "Changed Value" (Current or Preset) also.
Constant	Enter a constant to be added. (Initial value: 1)

◆Use example

1) Increment/decrement of "Number" object

- "1" is added or subtracted from the data in the "Number" object displayed on the screen.

"Number" object	
Word Device	D100
Digits	3
Decimal Point At	0
Data Size	16 bits
Displayed value	Current
Style	Decimal
Data Changeable	Effective (with a check mark)
Minimum Value	50
Maximum Value	300

- "▲" and "▼" on the touch keys are created using the "Text" object.
- Every time the touch key No. 0 (▲) is pressed, "1" is added to the current value of the "Number" object (D100). Every time touch key No. 1 (▼) is pressed, "1" is subtracted from the current value of the "Number" object (D100).
- When the current value of D100 becomes larger than the maximum value or smaller than the minimum value, error message "SET NUMBER IS INCORRECT." is displayed.
- The touch key No. is automatically assigned to each touch key when the touch key is created.

"Increment" object	
Control Input	Touch key No. 0
Word Device	D100
Data Size	16 bits
Displayed value	Current

"Decrement" object	
Control Input	Touch key No. 1
Word Device	D100
Data Size	16 bits
Displayed value	Current

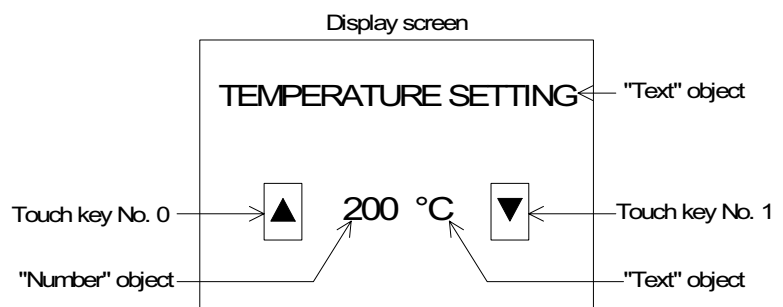

- When "Data Changeable" is made effective for the "Number" object, data can be directly changed. (Refer to Section 7.5.)
When the "Number" object is touched, the ten-key pad is displayed.

18.6.7 Decrement

The "Decrement" object subtracts "1" from the data of a specified word device when a touch or function key is pressed.

The contents of setting are equivalent to those for the "Increment" object.

◆Contents of setting

Equivalent to those for the "Increment" object.

■Important point

1) Data change condition

"✓" indicates that data change is enabled.

PLC	FX Series	A Series
PLC memory type	✓:RAM ×:EPROM *1 ×:EEPROM *1 When the read/write destination is a data register, data can be transferred without regard to the memory type.	✓:RAM ✓:EPROM
PLC operation status	✓:RUN ✓:STOP	✓:RUN ✓:STOP
GOT memory type	✓:Flash memory	✓:Flash memory
PLC entry code	×: While entry code is registered (while write is forbidden)	✓: While entry code is unlocked or is not registered

18.6.8 Data Setting

The "Data Setting" object automatically displays the ten- or sixteen-key pad (keyboard) and allows change in the set or current value of a specified word device when a specified touch or function key is pressed.

As the key pad is displayed only when it is required, the screen can be used efficiently.

The "Data Setting" object is called keyboard call type. The "Keyboard" object described later is called keyboard resident type. These objects can be used in accordance with the situation.

◆Contents of setting

Attribute	Contents of setting	
Control Input	Enter a key which displays the keyboard.	
Position	Enter the keyboard display position.	← 1)
Keyboard Type	Enter the keyboard type.	← 2)
User ID	Enter the user ID of an object whose data is to be changed.	← 3)

1) Position

Enter the X and Y coordinates of the start point from which the keyboard is displayed.

2) Keyboard Type

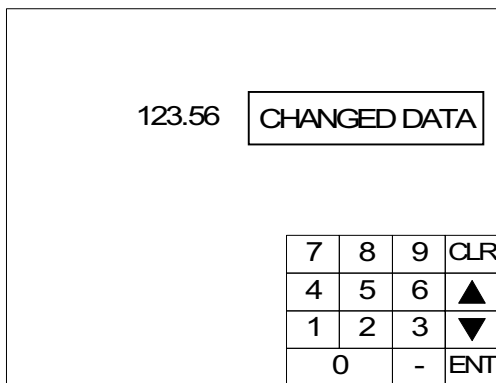

3) User ID

Enter the ID No. of the "Number" or "Ascii" object whose data is to be changed. The object having this ID can now be changed.

■Important point

- Data change

The data can be changed without using the "Data Setting" function. When the displayed "Number" or "Ascii" object is touched, the ten-key pad is displayed to enable data change. (Refer to Section 7.5.)

Do not set two or more "Data Setting" to one touch key or one function key.

When changing multiple data, choose the "Number" object to which the "Data Setting" is to be executed by operating the displayed [▲/▼] key in the ten-key pad.

◆Display example

- The keyboard manipulation procedure is described below using an example.
Display example:
 - The data in the "Number" object set as follows is changed.

"Data Setting" object	
Control Input	Touch key No. 0
Word Device	D100
Data Size	16 bits
Changed Value	Current
Keyboard Type	DEC8x4 (8x4 mesh for decimal input)

"Number" object	
Word Device	D100
Digits	6
Decimal Point At	0
Data Size	16 bits
Displayed value	Current
Format	Decimal
Data Changeable	Effective (with a check mark)
Minimum Value	-20000
Maximum Value	20000

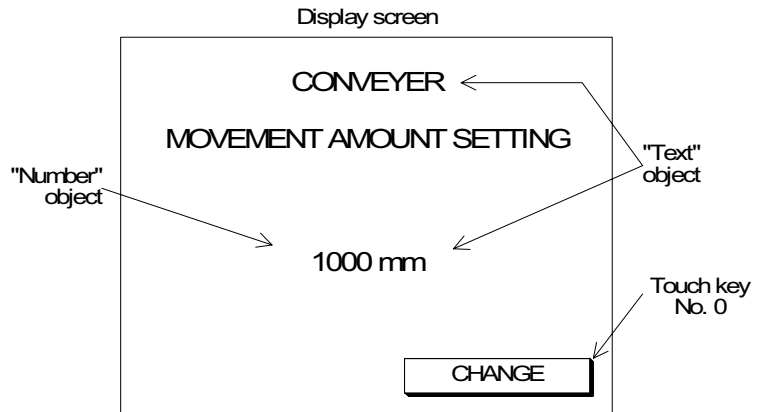

- When touch key No. 0 is pressed, the keyboard is displayed in the specified position.
- Characters "CHANGE" on the touch key is created using the "Text" object.

CHANGE

- When the "Number" object is pressed, its lowest digit is displayed in reverse to indicate that data can be changed.
- Enter new data using the keyboard.

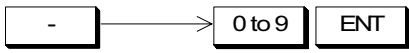

When entering minus data Enter desired new data.

Press the CLR or ENT key to register the input and clears the keyboard from the screen.

Confirm the new value is displayed in the "Number" object in which the cursor is located.

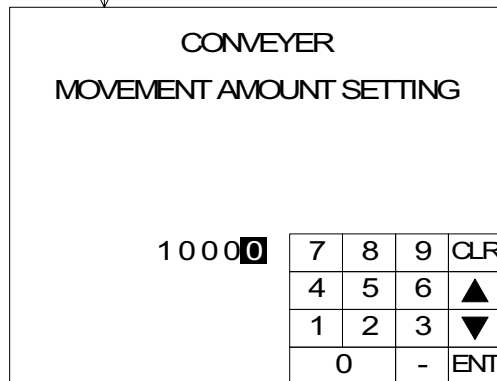

■Important point

1) Rule on data change

- When changing data, make sure to display the "Number" object whose "Word Device" is equivalent to "Word Device" of the "Data Setting" object on the same screen.
The following restrictions are imposed on data change.
 - 1) "Data Changeable" of the "Number" object should be made effective with a check mark when the "Number" object is registered. If it is not made effective, the keyboard is not displayed even when the touch key or function key to call the keyboard is pressed.
 - 2) The data in the "Number" object can be changed within the range determined by "Minimum Value" and "Maximum Value".
 - 3) When a hexadecimal value (H) is displayed on the screen, make sure to use the keyboard for hexadecimal input. When a decimal value is displayed, any keyboard can be used.

2) Timing of data change

- When the ENT key is pressed, the entered data is written to the PLC. The condition for data change is equivalent to that for the "Increment" and "Decrement" objects. Even while data is changed, monitors for numerics, bar graphs, etc. on the screen are operating.

18.6.9 Keyboard

The "Keyboard" object displays a keyboard for numerical input used to change data of a "Number" object.

The "Keyboard" object always displays a keyboard on the screen. Except when the "Data Setting" object is used, then a keyboard is displayed only when it is called.

(Unavailable in the F920GOT-K)

◆Contents of setting

Attribute	Contents of setting
Position	Enter the X and Y coordinates in the unit of dot.
Type	Select the keyboard type. ←1)

- Type
Select one among the following keyboards.

F930GOT-K, F930GOT, F933GOT

[Keyboards dedicated to input of decimal values]

DEC(H)

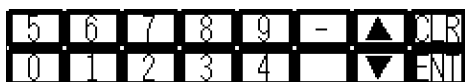

DEC

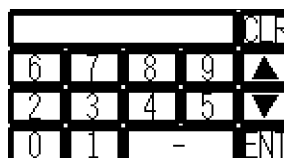

[Keyboards dedicated to input of hexadecimal values]

HEX

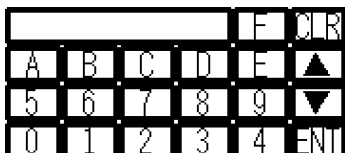

F940GOT, F943GOT, F940WGOT
 [Keyboards dedicated to input of decimal values]

DEC 8 × 4

7	8	9	CLR
4	5	6	^
1	2	3	v
0	-	ENT	

DEC 8 × 8

7	8	9	CLR
4	5	6	^
1	2	3	v
0	-	ENT	

DEC 16 × 2

5	6	7	8	9	-	^	CLR
0	1	2	3	4		v	ENT

DEC 16 × 4

5	6	7	8	9	-	^	CLR
0	1	2	3	4		v	ENT

[Keyboards dedicated to input of hexadecimal values]

HEX 10 × 4

C	D	E	F	CLR
8	9	A	B	^
4	5	6	7	v
0	1	2	3	ENT

HEX 10 × 8

C	D	E	F	CLR
8	9	A	B	^
4	5	6	7	v
0	1	2	3	ENT

[Keyboards dedicated to input of ASCII codes]

ALPHANUM1 16 × 5

A	B	C	D	E	F	BS	CLR
G	H	I	J	K	7	8	9
L	M	N	O	P	4	5	6
Q	R	S	T	U	1	2	3
V	W	X	Y	Z	0	-	ENT

ALPHANUM2 16 × 5

A	B	C	D	E	F	G	CLR
H	I	J	K	L	M	N	BS
O	P	Q	R	S	T	U	^
V	W	X	Y	Z		SP	v
ABC	abc	NUM	SYM				ENT

◆Example

The keyboard manipulation procedure is described below.

- When the displayed "Number" object is pressed, its lowest digit is displayed in reverse to indicate that it can be changed.

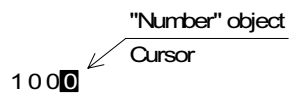

- When there are other "Number" objects, move the cursor to a "Number" object whose data is to be changed next.

Enter new data using the keyboard.

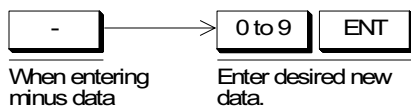

■Important point

1) Rule on data change

- When changing the data, make sure to display the "Number" object whose "Word Device" is equivalent to "Word Device" of the "Data Setting" object on the same screen. The following restrictions are imposed on data change.
 - 1) Data Changeable" of the "Number" object should be made effective with a check mark when the "Number" object is registered. If it is not made effective, the keyboard is not displayed even when the touch key to call the keyboard is pressed.
 - 2) The data of the "Number" object can be changed within the range determined by "Minimum Value" and "Maximum Value".
 - 3) When a hexadecimal value (H) is displayed on the screen, make sure to use the keyboard for hexadecimal input. When a decimal value is displayed, any keyboard can be used.

2) Timing of data change

- When the ENT key is pressed, the entered data is written to the PLC. The condition for data change is equivalent to that for the "Increment" and "Decrement" objects. Even while data is changed, monitors for numerics, bar graphs, etc. on the screen are operating.

3) Data change condition

"✓" indicates that data change is enabled.

PLC	FX Series	A Series
PLC memory type	✓:RAM ✗:EPROM *1 ✗:EEPROM *1 When the read/write destination is a data register, data can be transferred without regard to the memory type.	✓:RAM ✓:EPROM
PLC operation status	✓:RUN ✓:STOP	✓:RUN ✓:STOP
GOT memory type	✓:Flash memory	✓:Flash memory
PLC entry code	✗: While entry code is registered (while write is forbidden) ✓: While entry code is unlocked or is not registered	✗: While entry code is registered (while write is inhibited) ✓: While entry code is unlocked or is not registered

18.6.10 Change Screen

The "Change Screen" object changes over the currently displayed screen to a specified screen.

◆ Contents of setting

Attribute	Contents of setting
Control Input	Enter a key which actuates screen changeover.
Bit Device	Enter a bit device which actuates screen changeover.
Destination Screen.	Specify the changeover destination. Select one among "Direct", "PLC data register" and "DU memory".
Save Current Screen in DU-Memory	Set whether or not the screen No. before changeover is to be stored in the memory.

◆ Use example

Refer to "19. Change Over of Display Screen".

18.6.11 Alarm history display function

When the alarm device set in the screen creation software becomes ON, a message corresponding to the alarm device as well as the date and time when the alarm device became ON are displayed on a user screen. The date and time at which the alarm device became OFF can be also displayed.

◆Contents of setting

Attribute	Contents of setting
Display format	<ul style="list-style-type: none"> Title (which may be changed) Width (display size in the horizontal direction: full-width × width) Color (The display color and title color are set in the basic setting.) Contents (Date, time and characters can be specified.) Characters (to be displayed when characters are selected as contents) Recovery column (whether or not the recovery column is to be displayed)
Display setting	<ul style="list-style-type: none"> Number of display lines (of alarm history), order of display (from the oldest one/ from the latest one) and character size
Position	<ul style="list-style-type: none"> Display position
Format	<ul style="list-style-type: none"> Figure (with a frame), frame color and title color
Character size	<ul style="list-style-type: none"> Character size

◆Display example

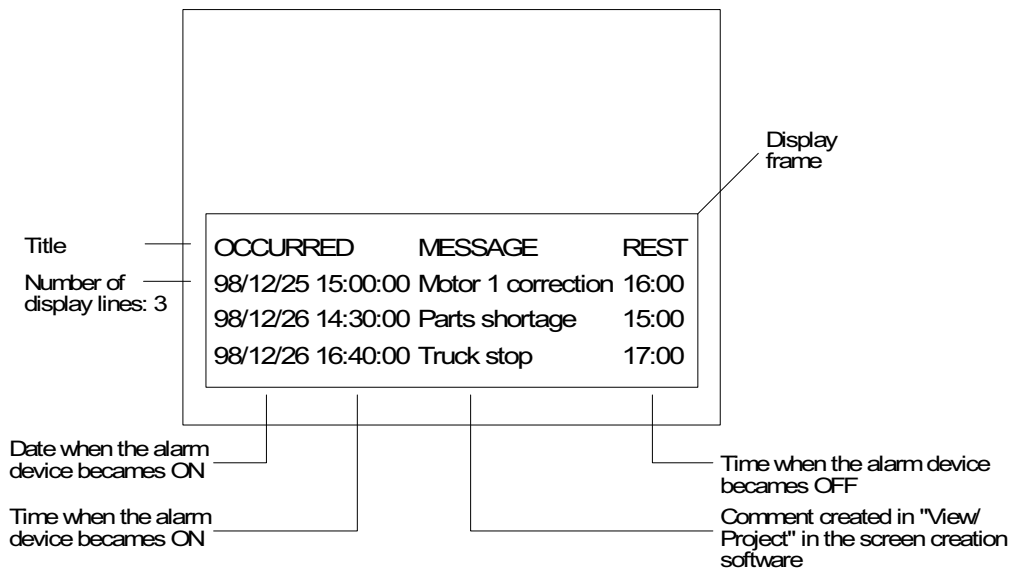

- The alarm device number and point or the message to display is set for "Alarms" in "View/Project".
- In the case of F940GOT, F943GOT with two-colored display (white/black), characters in each object of the alarm history display and alarm list display is displayed in black (characters in the cursor line is displayed in white). This means that only one line in which the cursor is located is legible if the screen color is black. When using these objects in F940GOT-LWD-E and F943GOT-LWD, the background color should be white.
- When displaying Date and Time simultaneously in the F920GOT-K, only the combination of "mm/dd" and "hh:mm" is available.

- Combination of touch keys (Excluding F920GOT-K)
If a touch key is placed on an alarm history screen and assigned a key code from the table below, it will perform its respective operation, shown in the table.

Key codes used for the alarm history function

Key code	Operation
FFB0	Displays the cursor.
FFB1	Deletes the cursor.
FFB2	Moves the cursor upward.
FFB3	Moves the cursor downward.
FFB6	Deletes the selected content of alarm.
FFB7	Deletes the content of all alarms.

- When "Comment Window" is selected

When this button is pressed, the detailed display window is closed.

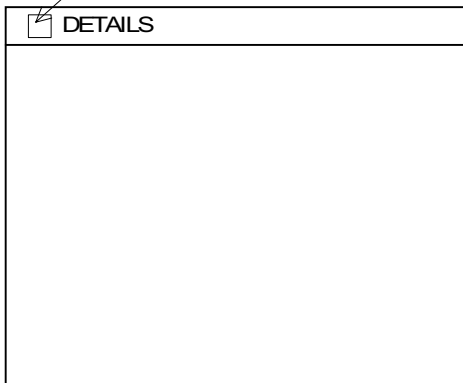

- Move the cursor to the alarm message to be displayed in detail and press the DETAIL key. Then, the detailed display window is open as shown on the left.
- The comment in the comment list specified by "Detail Display No." in "Alarm History Common Setting" – "Device Monitor" – "Edit" of the screen creation software is displayed.

18.6.12 Alarm list display function

When a specified device becomes ON, the corresponding message is displayed. By using the alarm list display function, the setting different from that in the alarm mode described in Chapter 12 or in the alarm history display function can be performed.

◆Contents of setting

Attribute	Contents of setting
Element setting	<ul style="list-style-type: none"> • Head bit element • Number of alarms (When a device specified here becomes ON, the corresponding message is displayed.) • Head comment number (number of comment created in "Comment" in the screen creation software) • Number of displayed lines (Two or more, or one. In the case of two or more lines, they are displayed in order of appearance.) • Display order (ascending/descending / from oldest/from latest)*1 → Only ascending/descending order settings are valid in the F920GOT-K. • Storage of number of occurrences (The number of times of becoming ON of the specified device is stored in the specified word device.)
Format	<ul style="list-style-type: none"> • Figure (with a frame), frame color, plate color and display size
Option	<ul style="list-style-type: none"> • Save in memory (Even while the alarm list function is not displayed on the screen, the ON/OFF status of alarm devices can be acquired.)*2 • Data/time display (The date/time when a specified device became ON is displayed.)*2 • Scroll • Detailed display (comment window/base screen changeover) • Position • Character size

*1 Display order of "from oldest/from latest" is available for the following versions.
 F930GOT-K: First product, F930GOT, F933GOT: V4.10 or later,
 F940GOT, F943GOT: V6.10 or later, F940WGOT: V1.10 or later
 Only ascending/descending order settings are valid in the F920GOT-K.

*2 Unavailable in the F920GOT-K

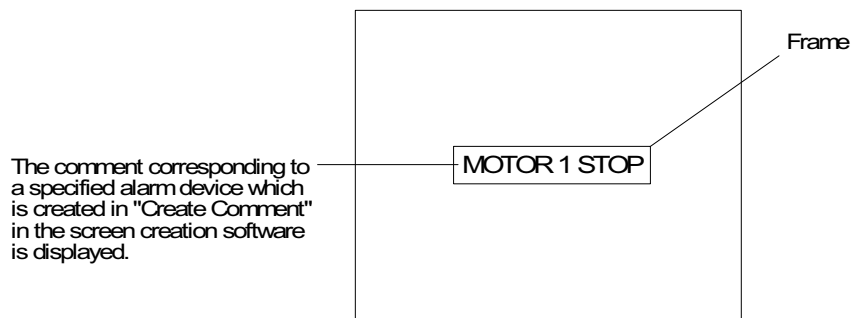
◆Display example

- In the case of F940GOT, F943GOT with two-colored display (white/black), characters in each object of the alarm history display and alarm list display is displayed in black (characters in the cursor line is displayed in white). This means that only one line in which the cursor is located is legible if the screen color is black. When using these objects in F940GOT-LWD-E and F943GOT-LWD, the background color should be white.

- Combination of touch keys (Excluding F920GOT-K)
If a touch key on the alarm list is assigned with a key code from the table below, it will perform its respective operation, also shown in the table.

Key codes used for the alarm list function

Key code	Operation
FFB0	Displays the cursor.
FFB1	Deletes the cursor.
FFB2	Moves the cursor upward.
FFB3	Moves the cursor downward.
FFB8	Displays the detailed information of the alarm selected by the cursor.
FFBB	Resets the alarm in the line in which the cursor is located.

When a touch key to which "FFB8" (detailed information display function) is assigned, the alarm message (comment window) or the base screen is changed over, and the detailed information is displayed.

To display the detailed information, "Detail Display Destination" in "Option" in "Alarm List Display Setting" of the screen creation software should be set to "Comment Window" or "Base Screen".

- When "Comment Window" is selected

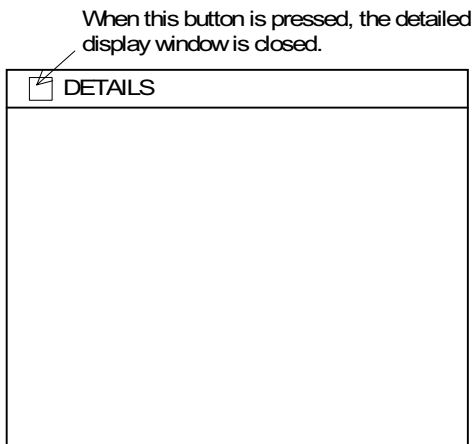

- Move the cursor to the alarm message to be displayed in detail and press the DETAIL key. Then, the detailed display window is open as shown on the left.
- The comment in the comment list specified by "Detail Display No." in "Alarm List Display Setting" – "Detail Display Setting" of the screen creation software is displayed.

- Changeover of base screen

The screen specified by "Detail Display No." in "Alarm List Display Setting" – "Option" of the screen creation software is displayed.

18.6.13 Buzzer

The "Buzzer" object issues buzzer sounds in the GOT when a specified bit device in the PLC becomes ON.

Setting screen: Displayed when "Object" – "Indicator" – "Buzzer" are selected.

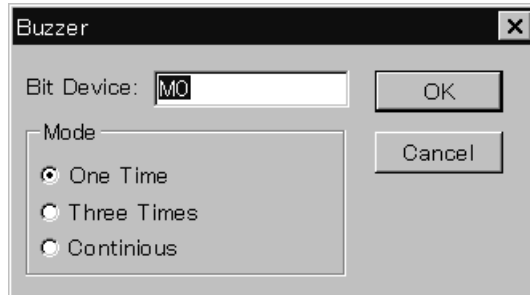

◆Contents of setting

Attribute	Contents of setting
Bit Device	Enter a bit device to be referred to.
Mode	Select one among "One Time", "Three Times" and "Continuous".

◆Contents of operation

One Time: When a specified bit device becomes ON from OFF, a short buzzer sound is issued once (in the same way as when a key is pressed).

Three Times: When a specified bit device becomes ON from OFF, a short buzzer sound is issued three times (in the same way as when an error has occurred).

Continuous: When a specified bit device becomes ON from OFF, buzzer sound is issued continuously.

- The buzzer sound can be enabled from the GOT by setting a "Buzzer" object in the screen data
(When using FX-PCS-DU/WIN-E) or by using GB (GOT internal bit).
For the GB (GOT internal bit) method, refer to Chapter 15.

■Important point

- Sequence program
The GOT refers to the ON/OFF status in the PLC at every 200 to 300 ms. A bit device specified in the "Buzzer" object should remain ON for 300 ms or more.
When using the F920GOT-K, the monitor interval greatly changes according to the processing situation (such as the alarm or observe status function).
The pulse change may not be caught if there are many tasks and the pulse interval of the condition devices is short. In order to catch the pulse change, make sure to maintain the ON/OFF status of the condition device for a sufficient length of time.

18.7 Text library

The text library stores texts to be displayed by the "Library Text" and "Text Indicator" objects. The text library data is stored in the flash memory.

- Texts stored in the library can be created using the screen creation software. The figure below shows the Text Library screen.

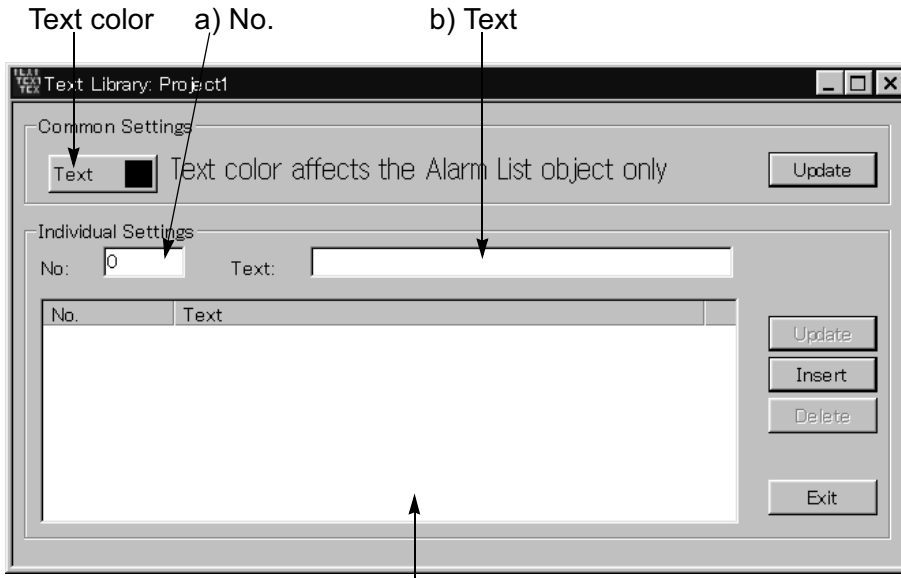

The numbers and character strings already registered are displayed in the list.

a) Numbers

A registration Numbers assigned to each registered text is used to display the "Library Text" and "Text Indicator" objects in the GOT.

Up to 2,000 texts (Nos. 0 to 1999) can be registered in the library.

b) Text

Enter a text to be registered in the library.

F920GOT-K

Up to 21 characters (when using 6 x 8 dots font)

F930GOT-K, F930GOT, F933GOT

Up to 30 characters

F940GOT, F943GOT

Up to 40 characters

F940WGOT

Horizontal display: 60 characters

Vertical display : 29 characters

■Important point

In the "Library Text" and "Text Indicator" objects, "W (width)" of the character size can be set to × 1 to × 4 and "H (height)" of the character size can be set to × 0.5 to × 4 respectively.

18.8 Image library

The image library stores images to be displayed by the "Library Image", "Image Indicator" and "Image" objects. The image library data is stored in the flash memory.

- Images stored in the library can be displayed in the form of list in "Image Library", "View" in the screen creation software. The figure below shows the Image Library screen.

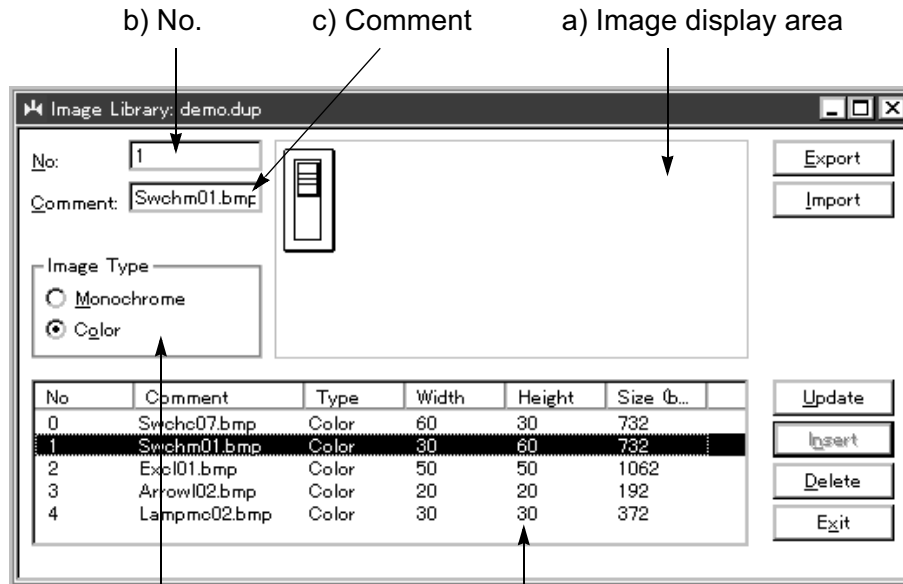

Displays the color type of the graphic displayed on the right area.

The numbers, comments, types and sizes already registered are displayed in the list.

a) Image display area

An image stored in the image library is displayed.

b) No.

A registration number assigned to each image is used to display the "Library Image", "Image Indicator" and "Image" objects in the GOT.

Up to 2,000 images (Nos. 0 to 1999) can be registered in the library.

c) Comment

The comment shown here can be used to estimate the contents of an image.

18.9 Data file

Data files store the data to be transferred by the "Send Data Banks" object.

- Data files can be created using the screen creation software. The figure below shows the Data Banks screen.

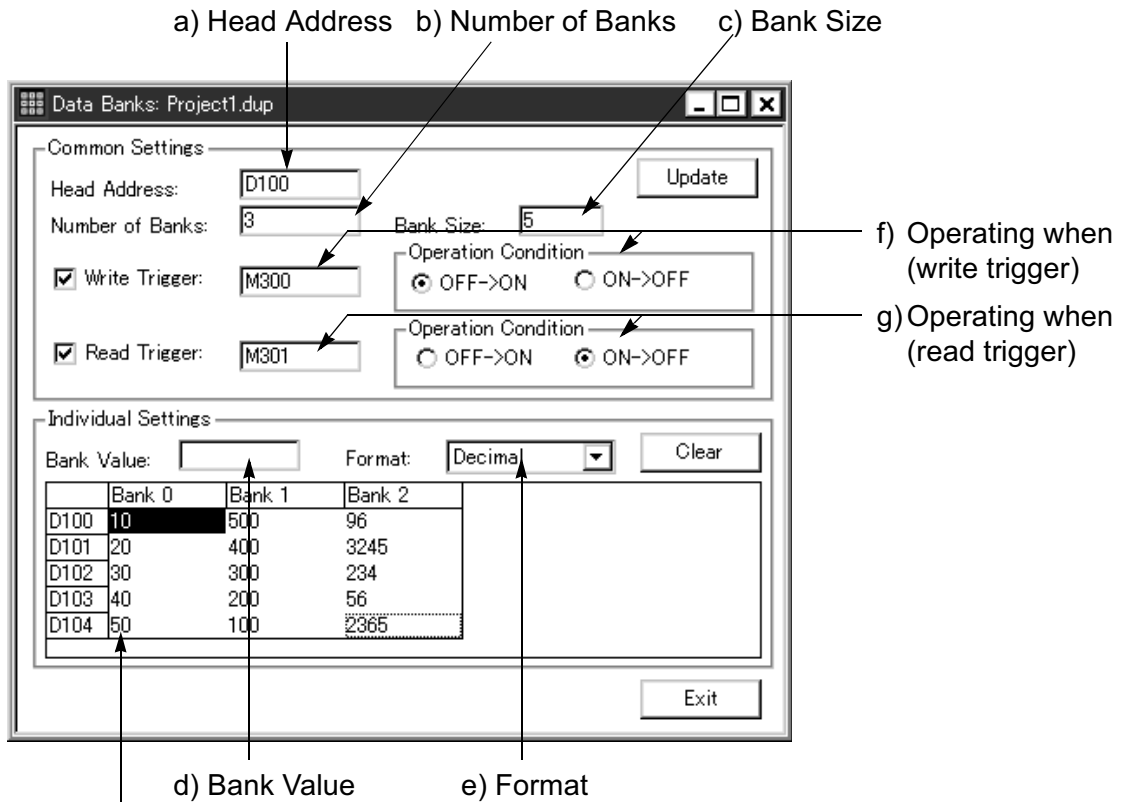

The data values of the data file registered are displayed in the table.

How to look at the table

- Longitudinal axis (data register)
Displays from the head address entered by the bank size entered.
- Lateral axis (bank)
Displays from 0 to the number of banks entered.

■Important point

Transfer from a personal computer

When the complete screen data is read from the personal computer, a data file containing the Recipe, Alarm Conditions, Sampling Conditions, and System Settings is transferred to the GOT along with the screen data.

The data file Read/Write characteristics vary per the GOT version as listed below.

- Changes made to the data file in the GOT cannot be read from the GOT.
 - F930GOT, F933GOT: prior to Version 4.30; F940GOT or F943GOT: prior to Version 6.30; F940WGOT: prior to Version 1.30.
- Changes made to the data file in the GOT can be read from the GOT.
 - F920GOT-K, F930GOT-K: First product, F930GOT, F933GOT: Version 4.30 or later; F940GOT or F943GOT: Version 6.30 or later; F940WGOT: Version 1.30 or later. "

- a) Head Address
Enter the head number of data registers (D) in the PLC used to transfer the data between the GOT and the PLC.
To clear all of the registered contents, enter "0".
In FX Series PLC, file registers (D1000 to D2999, D6000 to D7999) can also be specified. (The file register specifications vary depending on the model and the version. Before setting, confirm the device range of the connected PLC.)
- b) Number of Banks
Enter the number of data files.
To clear all the registered data, input "0" in "Number of Banks" and "Bank Size".
- c) Bank Size
Enter the number of data saved in one file.
To clear all the registered data, input "0" in "Number of Banks" and "Bank Size".
- d) Bank Value
Enter the data value using a decimal or hexadecimal value in accordance with the setting of "e) Format". A value within the range which can be set by word devices in the PLC can be entered.
In an FX Series PLC, a value in the 16-bit range which can be set to word devices can be entered. (Decimal value: -32768 to +32767, hexadecimal value: 0 to FFFF)
- e) Format
Select "Decimal" or "Hexadecimal" as the format of data displayed in the registered data file list and entered to "d) Bank Value".
- f) Operating when (write trigger)
Enter a bit device in the PLC which triggers data transfer (write) from a file register in the GOT to a data register in the PLC.
- g) Operating when (read trigger)
Enter a bit device in the PLC which triggers data transfer (read) from a data register in the PLC to a file register in the GOT.

■ Important point

- Available number of files and data size
A value within the range of 1 to 4000 can be entered to b) Number of Banks and c) Bank Size.
However, the number of files is limited as follows, and less than 4000 files may be available.
 - **Bank Size x Number of Banks shall be equivalent to or less than 4000.**
 - **Data register (D) in the PLC shall be more than "Bank Size".**

Example: In the FX PLC (There are 1000 data registers from D0 to D999.)

Bank Size: 3000 Number of Banks: 1 Head Address: D0	}	Cannot be set. (Because the bank size is 3000 while the number of registers in the PLC is 1000.)
---	---	--

18.10 Setting of backlight (F920GOT-K)

In the F920GOT-K, the backlight color can be set to white or red for each screen.

Setting operation

In the FX-PCS-DU/WIN-E, click "New" in "Screen List", then set the color in "Backlight Color". Select "White" or "Red" on the pull-down menu.

Setting screen

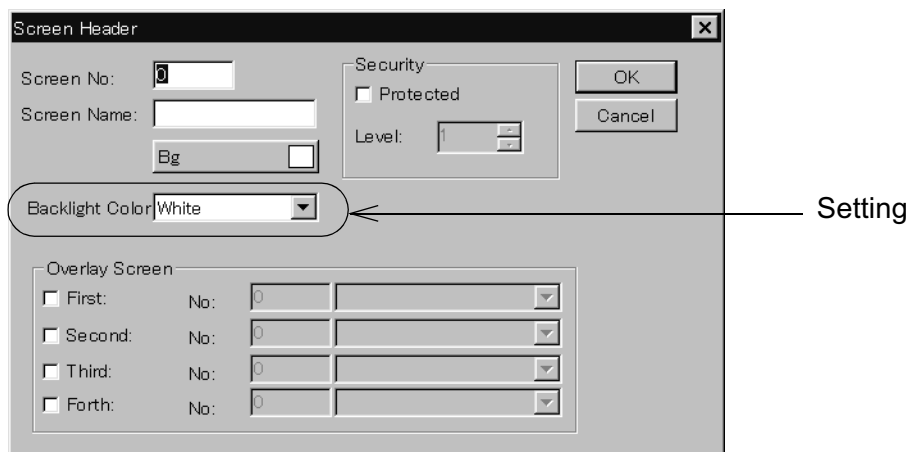

18.11 Assignment of LEDs (F930GOT-K)

In the F930GOT-K, each function key is equipped with a green LED which can be set ON and OFF using an arbitrary device.

Assign a device in "Output Indicator" in the screen creation software.

Eight devices are occupied from the device No. set in "Output Indicator". When the set device is ON, the green LED is ON. When the set device is OFF, the LED is OFF. If no device is set, the LED is always OFF.

Setting in the FX-PCS-DU/WIN-E

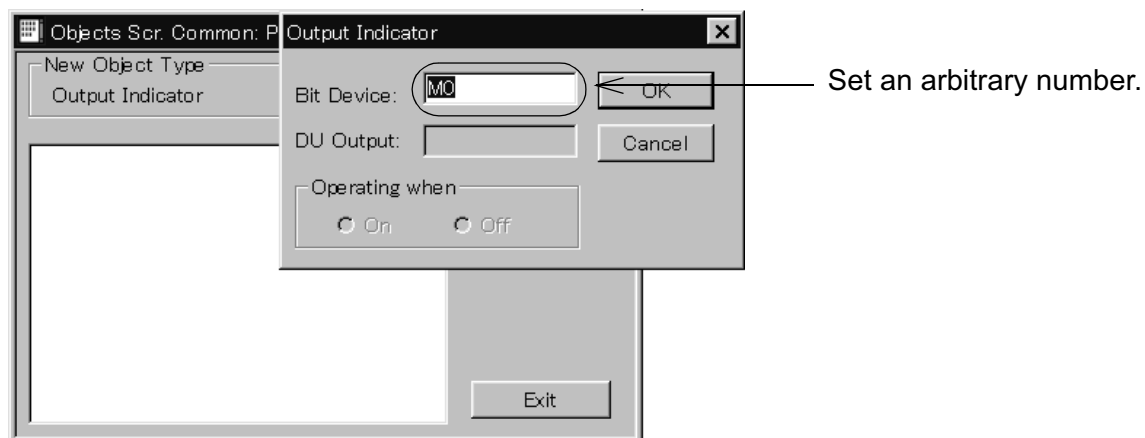

- Set "Output Indicator" for "Common Screen" in the FX-PCS-DU/WIN-E.
The "Output Indicator" setting is effective for the whole project. (A different setting for individual screen cannot be made.)

19. Changeover of Display Screen (FX-PCS-DU/WIN-E)

Chapter 18 describes how to change over two or more screens.

Screen changeover can be arbitrarily specified using operation keys in the GOT or from the PLC.

19.1 Outline of changeover of display screen

In the GOT, up to 500 screens can be created. A number from 0 to 499 is assigned to each screen.

A screen to be displayed next after the currently displayed screen should be specified using operation keys in the GOT or from the PLC.

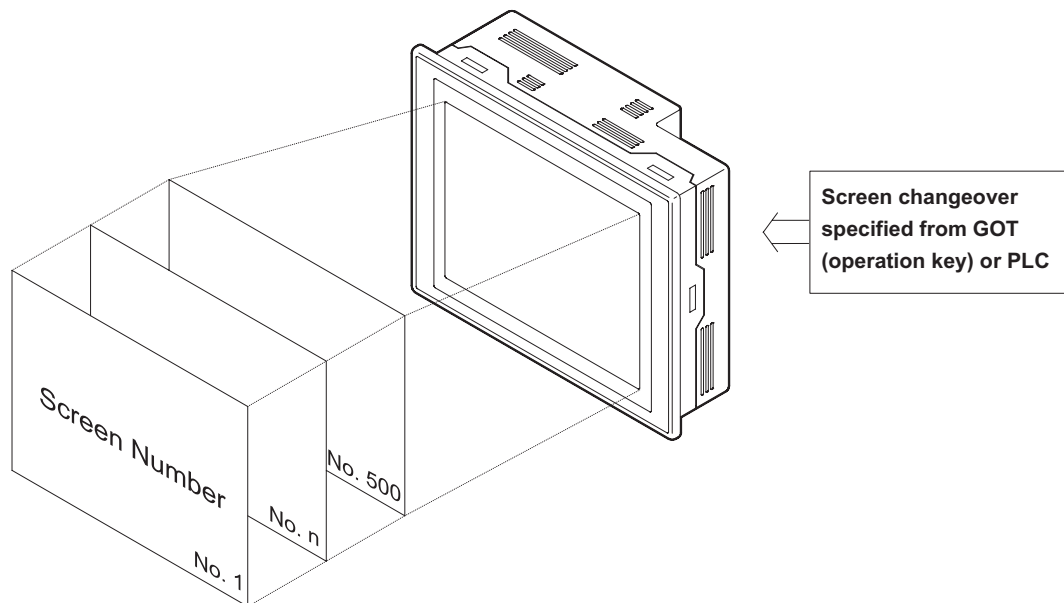

Not only user screens (No. 0 to 499) but also system screens (No. 1001 to 1030) in the "ALARM MODE" or "OTHER MODE" can be displayed.

■Important point

- 1) Creation of user screen No. 0
In the screen mode screen No. 0 is always displayed immediately after the power is turned on.
Accordingly, screen No. 0 should be created. If screen No. 0 is not registered, the error message "DISPLAY SCREEN IS NOT AVAILABLE." is displayed.
- 2) Screen numbers may not be consecutive.
Screen Nos. may not be consecutive in such a way as "0, 1, 2, 3 . . ."
When there is a possibility that some screens may be inserted in the future, inconsecutive screen numbers can be used.
However, it is recommended to use consecutive screen numbers because mistakes may be reduced in screen changeover.

19.2 "Change Screen" object

Use the "Change Screen" object to change over screens.

The "Change Screen" object is important. It allows to specify a screen to be displayed next after the currently displayed screen when the trigger condition (operation key in the GOT and bit device in the PLC) is satisfied.

19.2.1 Contents of setting

In the "Change Screen" object, the following three main items are to be set.

- 1) Condition
Set the condition which triggers screen changeover.
- 2) Destination Screen
Set the destination screen to be displayed when the trigger condition is satisfied.
- 3) Save Current Screen
Set whether or not the screen number of the currently displayed screen is to be stored in the memory before screen changeover.

Condition

Set the condition to trigger screen changeover.

An operation key in the GOT and a bit device in the PLC can be set here.

Set item		Description
Control Input (in GOT)	Touch key	Common setting for all screens: Touch keys No. 50 to 99 Setting for individual screen: Touch keys No. 0 to 49
	None	There is no condition for operation key.
Bit Device (in PLC)	Bit device	Bit device X, Y, M, S, T or C (a contact or b contact)
	None (Always Change)	There is no condition for PLC.

When both "Control Input" and "Bit Device" are satisfied, the display screen is changed over.

Destination Screen

Set the specification method of the destination screen to be displayed after the currently displayed screen.

When 1) Condition is satisfied, the screen is displayed in accordance with the specification method set here.

Set item	Description
Direct	When this item is selected, the number of a screen to be displayed next (one among user screens NO. 0 to 499 and system screens No. 1001 to 1030) can be entered here directly.
PLC data register	When this item is selected, a screen (one among the screens No. 0 to 499 and 1001 to 1030) stored in control devices (data registers D+0 to D+2) in the PLC is displayed next. * The control devices can be selected using the screen creation software.
DU memory	When this item is selected, a screen stored in the memory in the GOT is displayed next.

Save Current Screen

Set whether or not the screen number. of the currently displayed screen is to be stored in the memory before screen changeover. To save it, add a check mark.

The screen number saved by this function is regarded as the screen number to be displayed when "DU memory" is selected in "2) Destination Screen".

19.2.2 Operation of screen changeover

The "Change Screen" object can be registered for each individual screen or for all screens (common setting).

- Registration of the "Change Screen" object
 - Setting for individual screens
The setting is effective only while the registered screen is displayed.
Up to 50 objects in total can be registered including "Change Screen", "Switch", "Send Data Bank", "Increment", "Decrement" and "Data Setting" objects.
 - Common setting for all screens
The setting is effective on any screen.
Up to 50 objects in total can be registered including "Change Screen", "Switch", "Send Data Bank", "Increment", "Decrement" and "Data Setting" objects.
 - * Up to 50 objects in total can be registered including the setting for individual screen and the common setting for all screens.

Condition

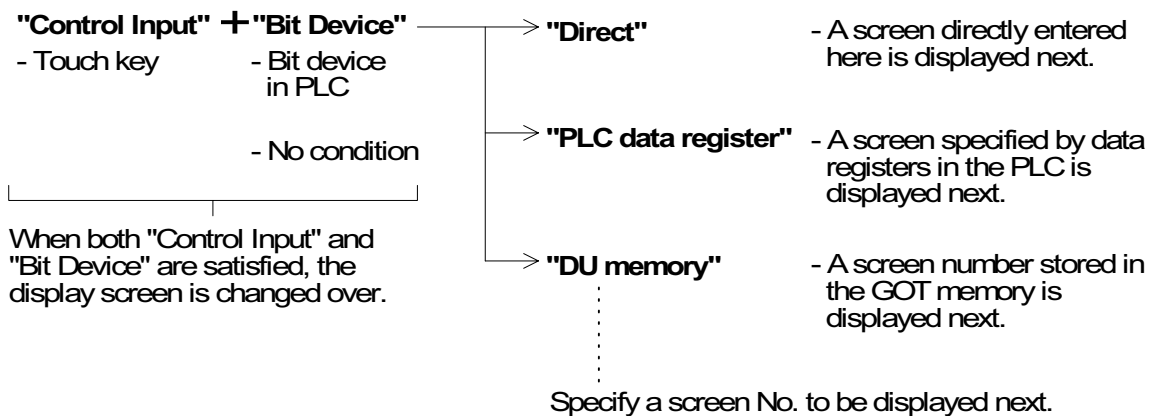

19.2.3 Timing of screen changeover

Inside the GOT, it is checked whether or not the screen changeover conditions specified by the "Change Screen" object are satisfied, in the order of the common setting for all screens and the setting for individual screen. When the specified conditions are satisfied, the next screen is displayed.

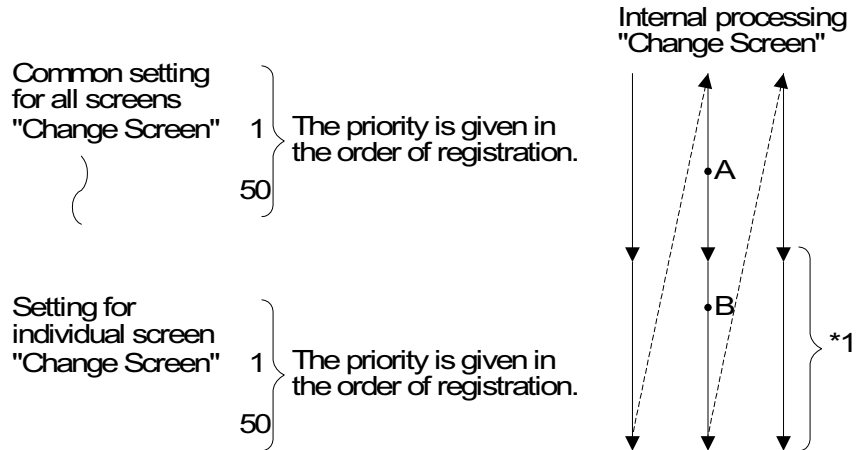

- For example, even if the screen changeover conditions for individual screen are satisfied at point A earlier than satisfaction of the screen changeover conditions for all screens at point B, the priority is given to the common setting for all screens and the screen specified by the common setting for all screens is displayed.

If two or more screen changeover conditions are satisfied at the same time, the screen is changed over in accordance with the setting of an object with highest priority.

*1 When screen changeover is performed, the "Change Screen" object for the previous individual screen is replaced with the "Change Screen" object for the new individual screen.

- Screen changeover is performed in accordance with the priority as described above. If the screen changeover condition is equivalent, the object registered later is ignored.

19.3 Screen changeover by touch key

This section describes screen changeover using a touch key.
(The F920GOT-K is not equipped with a touch key.)

When a touch key is used for screen changeover, the screen display is changed over to the specified destination when the touch key becomes ON. Enter an arbitrary touch key to "Control Input" in "Condition". Select "Direct" in "Destination Screen", and enter a desired screen number to "Screen No."

Specify a number for "Screen No." so that a fixed screen is displayed when a touch key is pressed.

Set item	Description
Control Input (in GOT)	Available touch keys Common setting for all screens: Touch keys No. 50 to 99 Setting for individual screen: Touch keys No. 0 to 49] 50 keys in total
Bit Device	Do not select "Bit Device". (Do not enter any bit device No.)
Screen No.	Enter the number of a screen to be displayed next among user screens No. 0 to 499 and system screens No. 1001 to 1030.

Example of screen changeover using touch keys

- Examples of screen changeover using touch keys are shown below. Set the "Change Screen" object for all screens (common setting) and for individual screen.
 - Common setting for all screens
In this example, screen No. 0 is displayed from any screen when the MENU key is pressed.
Characters "MENU" are displayed by the "Text" object.

Common Screen

	Condition		Screen No. (Direct)	Save Current Screen
	Control Input	Bit Device		
1	Touch key No. 50	Not specified	0	Not effective

← For Save Current Screen, refer to Section 20.5.

- Setting for individual screen

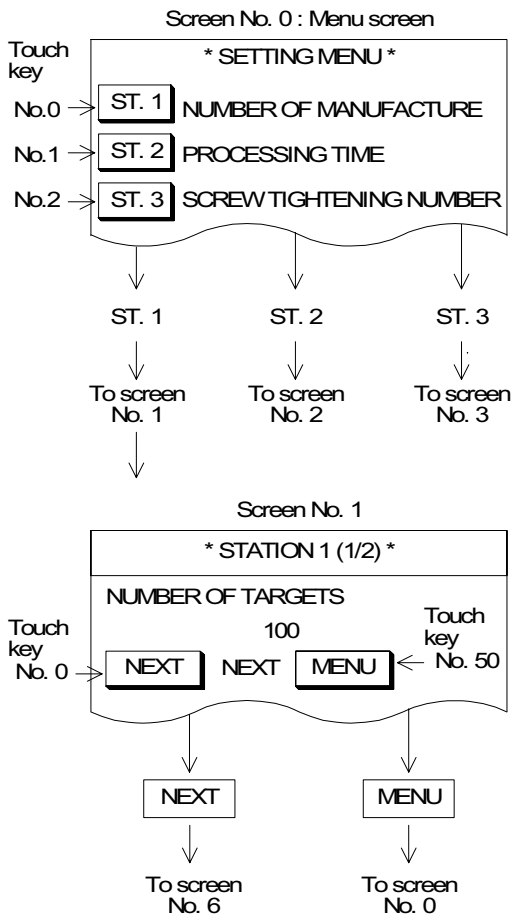

- Screen No. 0 is created, and screen changeover is set as follows.
Screen No. 0 is a menu screen.
When either of the ST. 1 to ST. 3 keys is pressed, a corresponding screen is displayed.

Individual Screen

	Condition		Screen No. (Direct)	Save Current Screen
	Control Input	Bit Device		
1	Touch key No. 0	Not specified	1	Not effective
2	Touch key No. 1	Not specified	2	Not effective
3	Touch key No. 2	Not specified	3	Not effective

- Characters "ST. 1" to "ST. 3" are displayed by the "Text" object.
- Screen changeover for screen No. 1 is set as follows.

Individual Screen

	Condition		Screen No. (Direct)	Save Current Screen
	Control Input	Bit Device		
1	Touch key No. 0	Not specified	6	Not effective

- When the "▼" key is pressed, screen No. 6 is displayed without regard to the ON/OFF status of bit devices in the PLC.
- When the MENU key is pressed, screen No. 0 is displayed in accordance with the setting of the "Change Screen" object set for all screens.

■Important point

1) Change of displayed data

If "100" on screen No. 1 is a "Number" object, the value "100" can be changed. (Refer to Section 7.5.)

2) Specification of touch key

When selecting "Control Input" in "Condition", enter a desired touch key number.

A touch key number starting from 0 is assigned automatically for each screen in the order of creation.

On the common screen, a touch key number starting from 50 is assigned.

19.4 Screen changeover using function keys

This paragraph explains screen changeover using the function keys (in the F920GOT-K and the F930GOT-K).

In screen changeover using the function keys, the screen is changed over in accordance with the contents of the changeover destination when the key input turns ON. Select the external key No., display the "Change Screen" dialog box, then set each item.

In order to display the screen of a fixed No. by pressing a function key, perform the following settings.

Set item	Description
Bit Device	Make "Bit Device" effective with a check mark, and enter a desired bit device (X, Y, M, S, T or C). In "Active when", select "On" (a contact) or "Off" (b contact).
Screen No.	Enter the number of a screen to be displayed next among user screens (No. 0 to 499) and system screens (No. 1000 to 1030).

Set the "Change Screen" object using a function key as an external key by selecting "Keys" → "External Key" in the screen creation software.

The "Change Screen" object can be set for all screens as the common setting or for individual screens.

In the F920GOT-K, the function keys are assigned as "External key 0", "External key 1", ... "External key 5" from the left.

In the F930GOT-K, the function keys are assigned as "External key 0", "External key 1", "External key 2" and "External key 3" from the left to the right in the upper row, and as "External key 4", "External key 5", "External key 6" and "External key 7" from the left in the lower row.

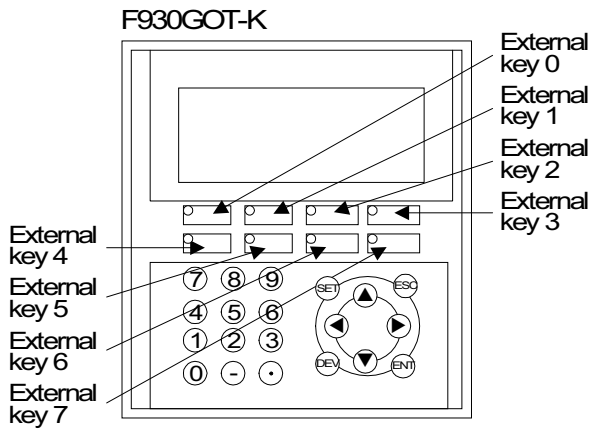
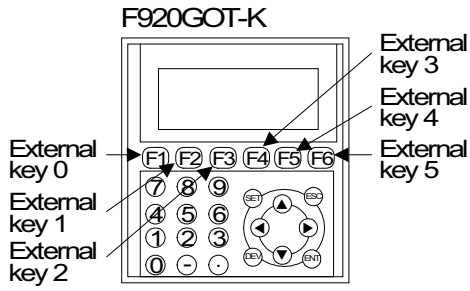

"Keys Scr." display in the FX-PCS-DU/WIN-E

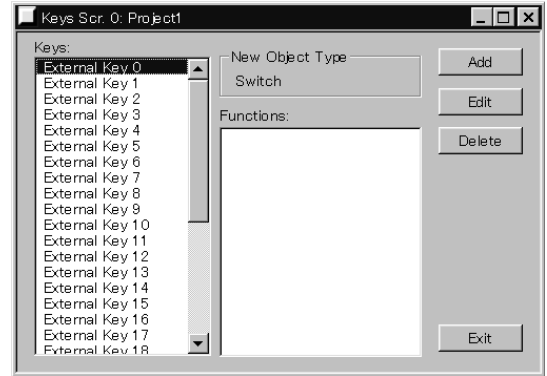

19.5 Screen changeover from PLC

From the PLC, a display screen can be changed using bit devices and word devices (data registers).

19.5.1 Screen changeover using bit devices

This section describes the method to display a specified screen when a bit device (X, Y, M, S, T or C) becomes ON or OFF.

Set item	Description
Control Input	Do not enter any touch key.
Bit Device	Make "Bit Device" effective with a check mark, and enter a desired bit device (X, Y, M, S, T or C). In "Active when", select "On" (a contact) or "Off" (b contact).
Screen No.	Enter the number of a screen to be displayed next among user screens (No. 0 to 499) and system screens (No. 1000 to 1030).

Display of screen by bit device

- An example of screen changeover by ON/OFF of a bit device in the PLC is shown below. In this example, the "Change Screen" object is set for an individual screen.
 - Setting for individual screen

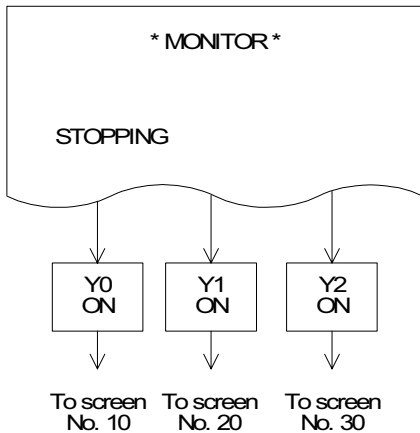

- Screen No. 0 is created, and the "Change Screen" object is set as follows.

Individual Screen

	Condition		Screen No. (Direct)	Save Current Screen
	Control Input	Bit Device		
1	Not specified	Y0/On	10	Not effective
2	Not specified	Y1/On	20	Not effective
3	Not specified	Y2/On	30	Not effective

- Example of sequence program

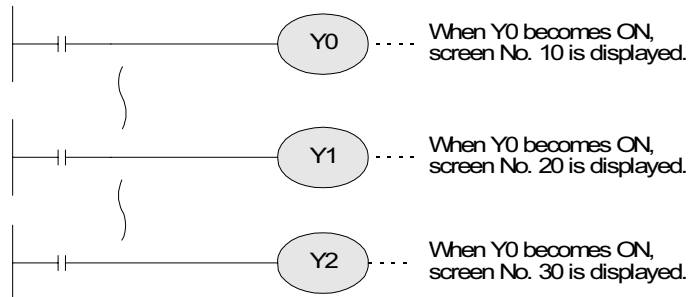

- If either of Y0, Y1 or Y2 (a contact) becomes ON while screen No. 0 is displayed, a corresponding screen is displayed.

19.5.2 Screen changeover by data register

The display screen can be changed by specifying the screen number using a word device (Only data registers are available.) in the PLC.

Set item	Description
Control Input Bit Device	Do not enter any touch key or bit device.
Destination Screen: PLC data register	Specify a desired screen number using a data register (control word device) for screen specification in the PLC. The data register can be set using the screen creation software. The initial value is D0. When the data in the register is changed, screen changeover is performed and the specified screen is displayed.

Example of screen changeover by data register

- An example of screen changeover by a data register (word device) is shown below. The "Change Screen" object is set for all screens (common setting).

- Common setting for all screens
The display is changed over to a screen having the number specified by a data register in the PLC without using the screen changeover condition.

Common screen

	Condition		Screen No. (Direct)	Save Current Screen
	Control Input	Bit Device		
1	Not specified	Not specified	PLC data register	Not effective

↑ ↑ See "Important point" below.

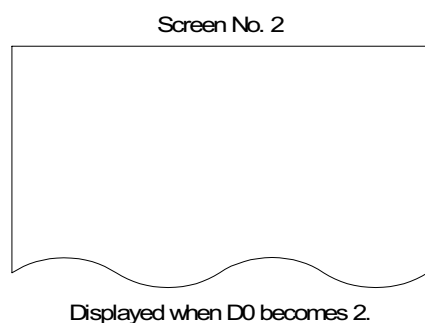
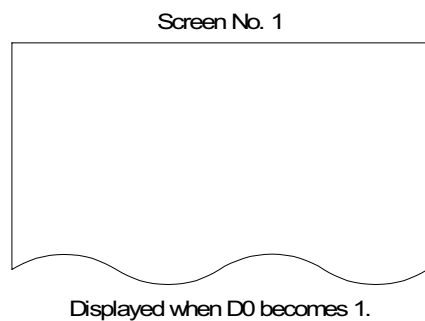
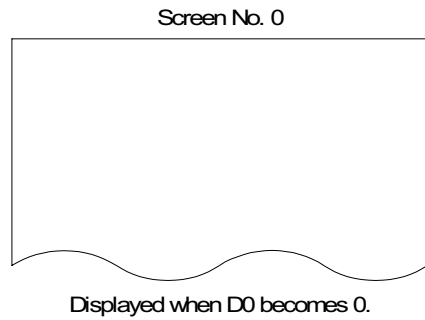

- Immediately after the GOT has been put into screen mode, screen No. 0 is always displayed. When the sequence program shown below is executed, the screen is changed over.

- Example of sequence program

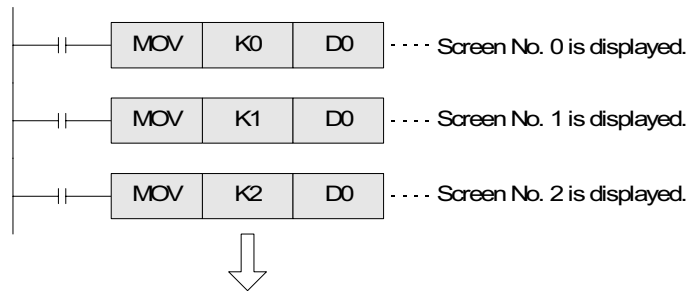

Though all of screens to be displayed can be specified from the PLC, the PLC program becomes long when many screens are specified.

- When screens will not be overlaid, enter "-1" to D1 and D2.

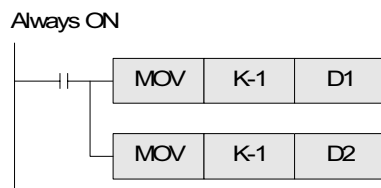

■ Important point

- Combination of other types of screen changeover:
When screen changeover by data registers is used together with screen changeover by another method (bit devices or touch keys), the priority is always given to screen changeover by data registers ("PLC data register") if both "Control Input" and "Bit Device" are not set because the changeover condition is not given.
When using different types of screen changeover together, refer to "19.7 Application of screen changeover".

19.6 Screen changeover by screen number stored in memory

This section describes the method to display a screen stored in the memory using the screen number storage function.

The screen number storage function can be set in the "Change Screen" object. Only when "Save Current Screen" of the "Change Screen" object is made effective with a check mark, a previously displayed screen is stored in the memory in the GOT.

Example

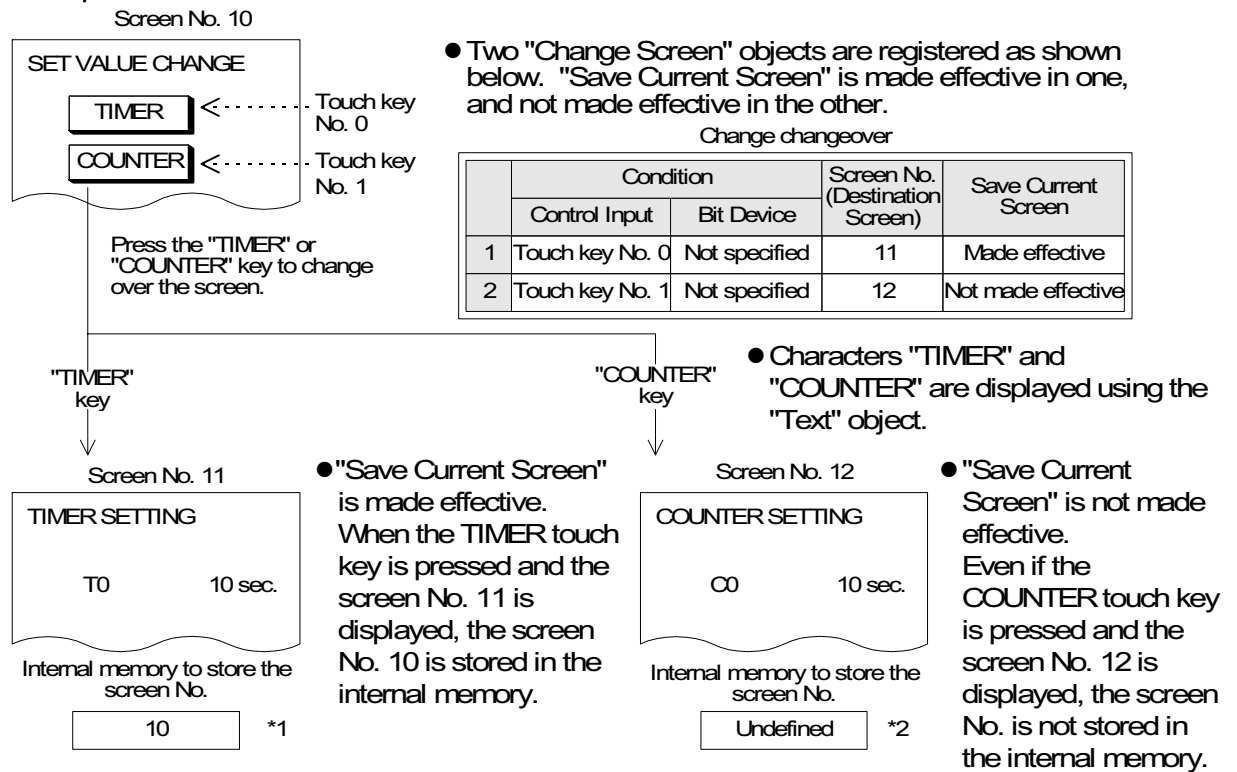

***1 Contents stored in the screen number storage memory**

The screen number storage memory in the GOT can store only one screen at a time. Accordingly, when "Save Current Screen" is made effective on a newly displayed screen, the contents of the memory is updated.

Example: Suppose that the screens are changed over as follows.

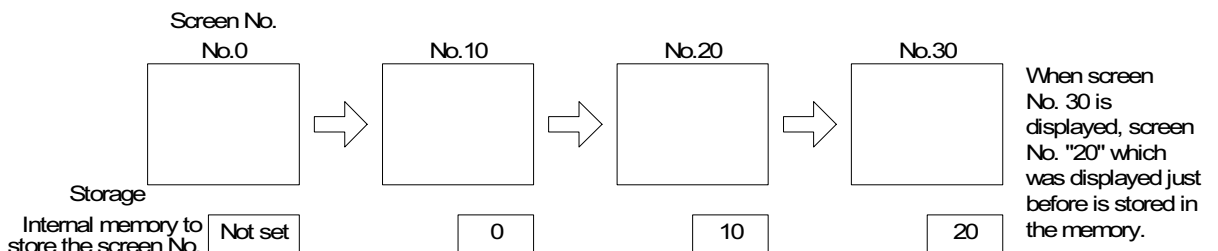

***2 Keeping of the contents stored in the screen number storage memory**

The contents stored in the screen number storage memory is kept only while the power is turned on in the GOT main body. When the power is turned off, the memory is cleared.

Example of screen changeover by screen number stored in memory:

An example of screen changeover by screen stored in memory is shown below. In the example below, an abnormality occurs in the machine in the operation mode, an error message is displayed, then the previous screen is displayed.

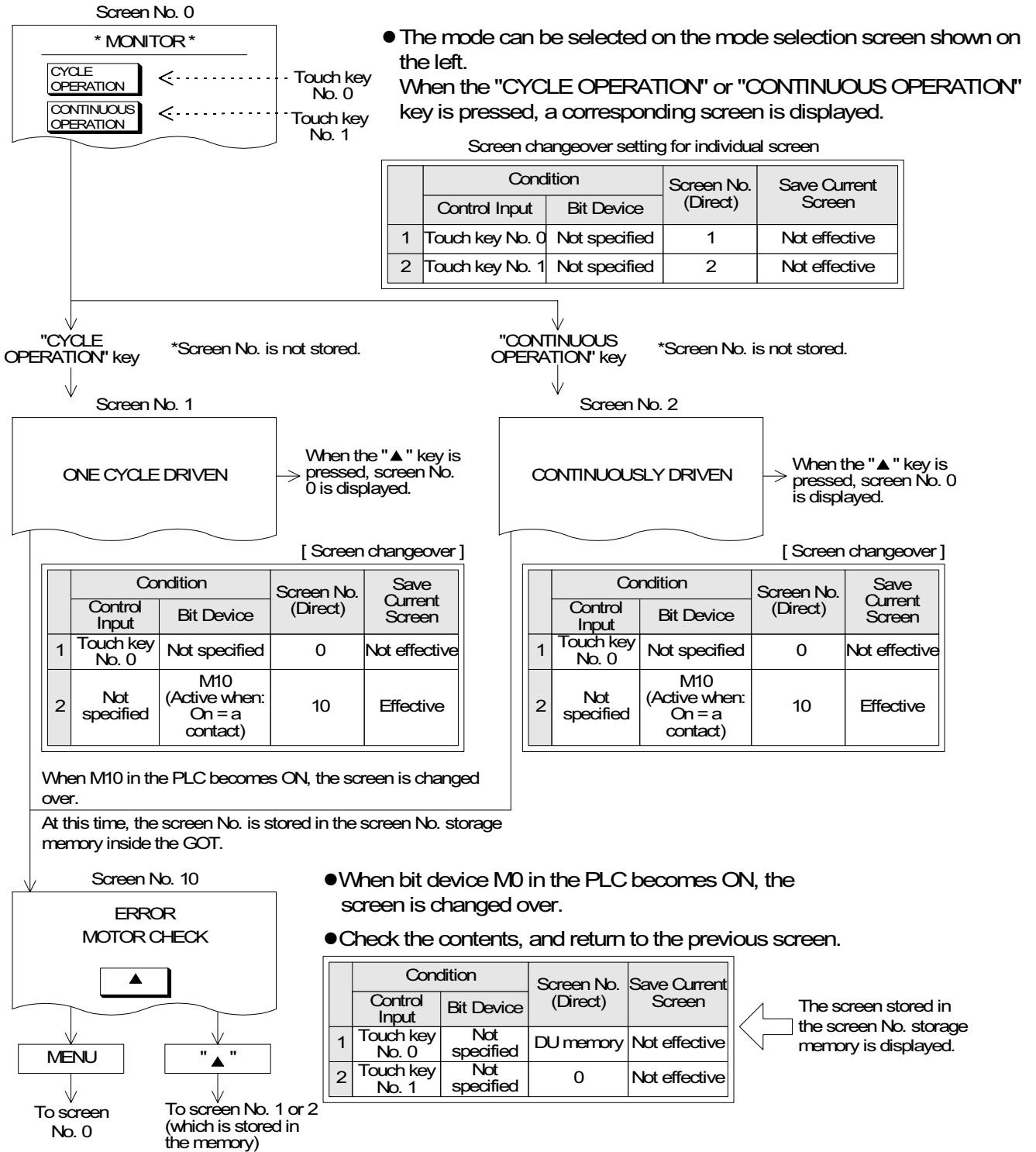

Use the screen number storage function when one screen has been specified among two or more screens, and the screen that was displayed prior to the screen changeover is to be displayed again.

19.7 Changeover to system screen

Function screens built in the GOT such as HPP MODE, SAMPLING MODE, ALARM MODE and OTHER MODE can be displayed as user screens.

19.7.1 Display of system screen

This section describes the method to display a system screen as a USER SCREEN MODE and the caution on this method.

- **A system screen can be displayed by specifying a corresponding screen number using the "Change Screen" object. (Refer to 22.4) Prior to this, "Save Current Screen" should be made effective so that the previous user screen can be displayed after the system screen.**

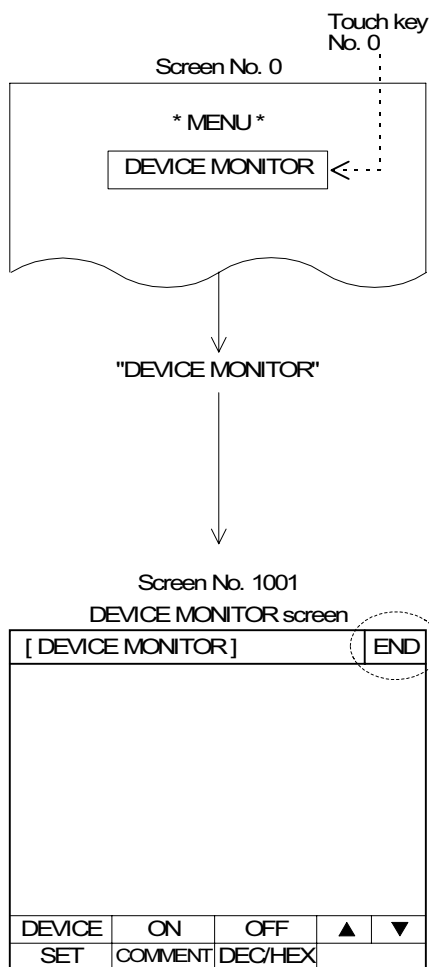

- Screen No. 0 is created as follows. The "Change Screen" object is set so that screen No. 1001 (DEVICE MONITOR screen) is displayed when touch key No. 0 (DEVICE MONITOR) is pressed.

Change Screen

	Condition		Screen No. (Direct)	Save Current Screen
	Control Input	Bit Device		
1	Touch key No. 0	Not specified	1001	Not effective

Make sure to set "Save Current Screen" effective. ↗

- For the operating procedures of each system screen, refer to description on each mode.
- When the END key is pressed, the previous screen (screen No. 0 in this example) is displayed again.

For the system screen number., refer to the appendix.

19.8 Application of screen changeover

This section describes an application example of screen changeover.

Example of screen changeover by touch key in the GOT and word device in the PLC

- In the example below, screen changeover by touch key and screen changeover by word device in the PLC are used together.
 - Common setting for all screens
 - The "Change Screen" object is set so that screen No. 0 is displayed when the MENU key is pressed.
 - This setting is suitable to read a certain screen such as the menu screen.
 - Characters for menu items are displayed using the "Text" object.

Common Screen

When the MENU key is pressed, the menu screen (screen No. 0) is displayed. ⇒

	Condition		Screen No. (Direct)	Save Current Screen
	Control Input	Bit Device		
1	Touch key No. 50	Not specified	0	Not effective

- Setting for individual screen

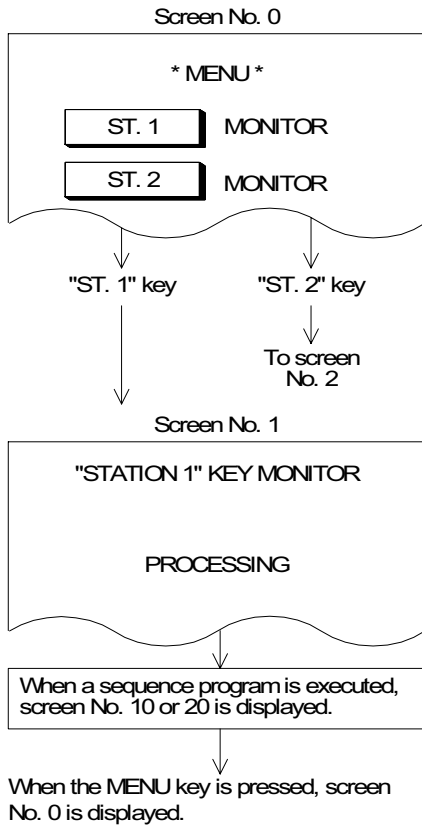

- Screen No. 0 is created, and the "Change Screen" object is set as follows.

Individual Screen

	Condition		Screen No. (Direct)	Save Current Screen
	Control Input	Bit Device		
1	Touch key No. 0	Not specified	1	Not effective
2	Touch key No. 1	Not specified	2	Not effective

- It is set so that screen No. 1 is displayed by a data register (word device) in the PLC. The initial value of the data register for screen changeover is D0.

Individual Screen

	Condition		Screen No. (Direct)	Save Current Screen
	Control Input	Bit Device		
1	Not specified	M100	PLC data register	Not effective

If "Bit Device" is not specified, both "Control Input" and "Bit Device" are not specified. Accordingly, the screen is changed over immediately by a data register in the PLC. For the condition to make screen changeover by data register effective, enter "Control Input" or "Bit Device" as shown in the program example 1 on the next page.

Continued in sequence program examples on the next page.

• Sequence program examples

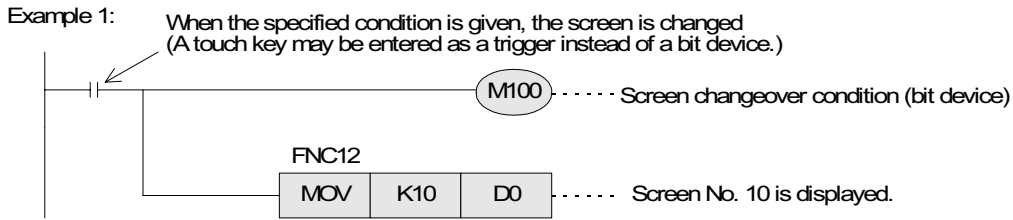

Example 2: When it should be confirmed that screen changeover has been securely performed by the specified condition, make a program shown below.

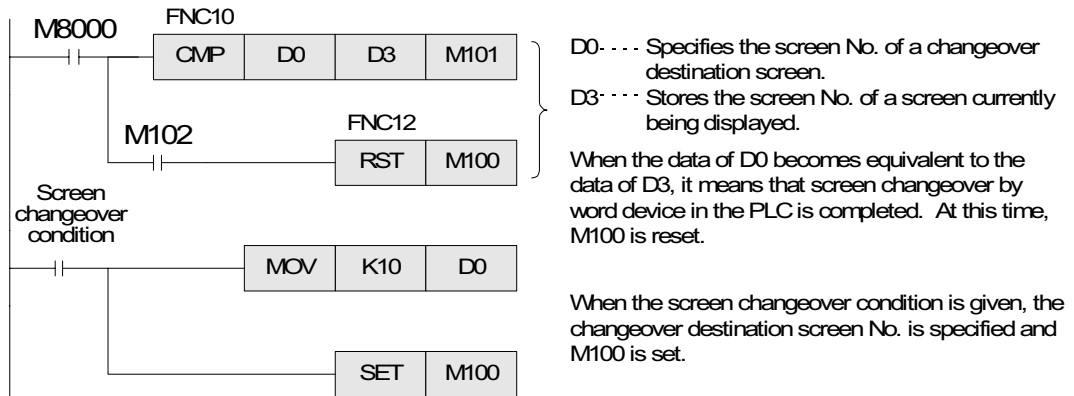

Combination of the "Switch" object and the "Change Screen" object

- There may be a case in which one touch key is required to function both as a switch and a control input for screen changeover. In such a case, the "Switch" object and the "Change Screen" object can be used together.

MEMO

20. Creation of Display Screen (GT Designer)

20.1 Project auxiliary settings

In the case of GT Designer, when the software is opened, a "Project Auxiliary Settings" screen is displayed after select project "New" - "GOT/PLC Type" Setting.

The "Project Auxiliary Settings" screen can be also displayed selecting "Common" - "Auxiliary Setting" - "Project" on the menu.

This setting can be also made using "SET-UP MODE" of the GOT (except dedicated setting item for F930GOT, F933GOT and F940WGOT).

On the "Project Auxiliary Settings" screen, make common settings for all the screens to create. Items written by the screen creation software are stored in the program memory and items set on GOT are written to the built-in RAM. If both "setting by the screen creation software" and "setting on the GOT" are performed, the GOT operates in accordance with the items set later. If the battery becomes low or the RAM fails, the GOT operates in accordance with the items set by the screen creation software.

When screen data is read from the GOT by the screen creation software, the items written by the screen creation software are displayed.

This section describes the elements constructing user screens created using GT Designer.

Project auxiliary settings screen (Example when choosing the F940GOT)

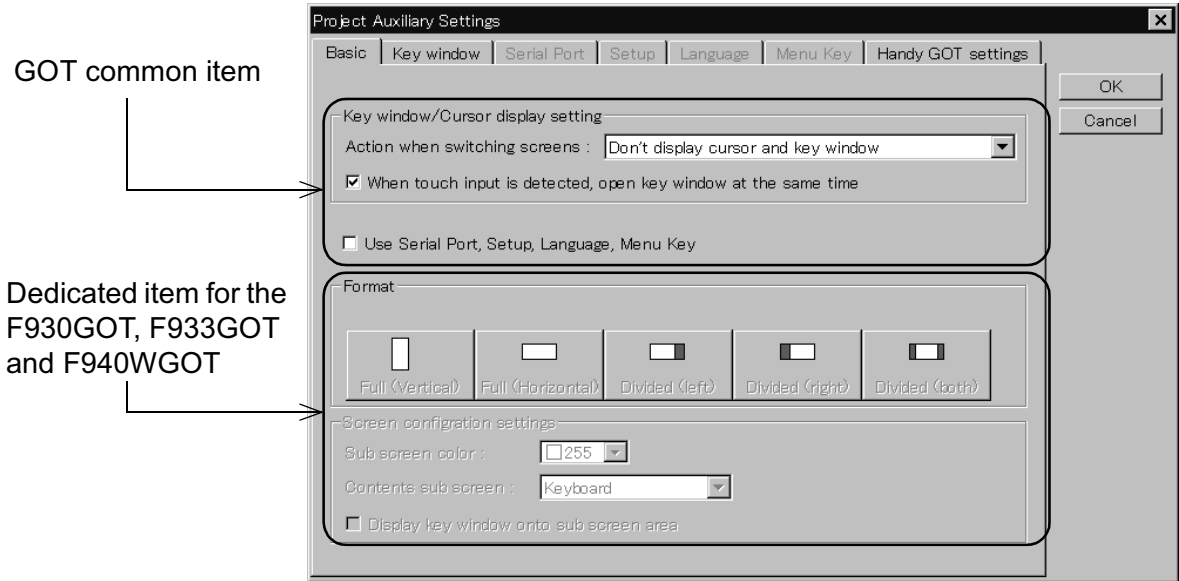

GOT common setting item:

Key window/Cursor display setting is performed when using the F930GOT-K, the key window and/or cursor are/is displayed or not displayed according to the combination of the settings created here and under the "Key window" tab. For details, refer to Section 7.6.3. A key window is not displayed when using the F920GOT-K. Checking "Use Serial Port, Setup, Language, Menu Key" will make it possible to display the respective sheets. The setting items of each sheet can be also set using "SET-UP MODE" of the GOT.

Dedicated items for the F930GOT and F940WGOT:

Setting is enabled only when the F930GOT or F940WGOT is selected for "GOT type". Set the "Format" and the background color and displayed contents in "Screen configuration settings" (only for F940WGOT). "Screen configuration settings" is available only when selecting "Divided (left/right/both)" for "Format". (The dedicated items can be selected in the screen creation software but not in the GOT.)

Key window setting screen

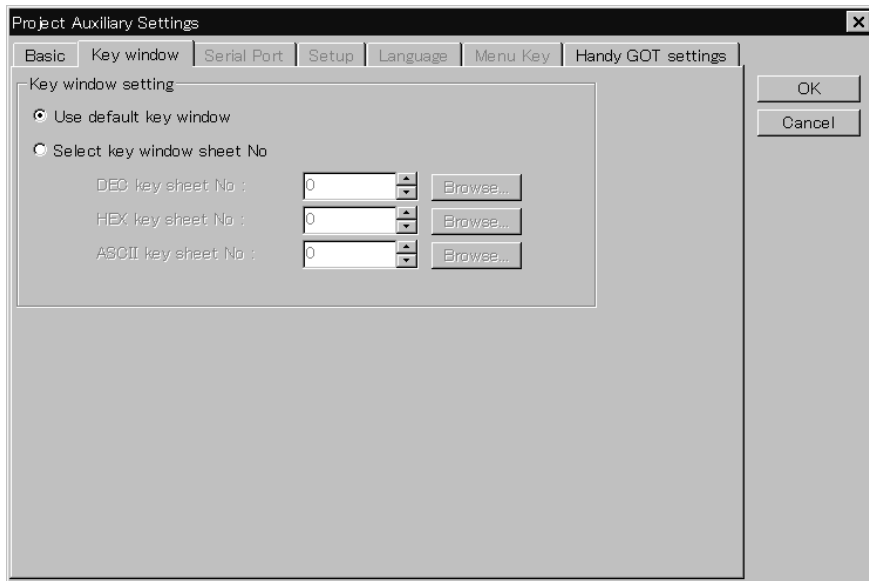

- The window screen should be created before choosing "Select key window sheet No." and setting the DEC/HEX/ASCII key sheet No.
(Because the window screen has not been created yet when "Project" – "New" are chosen, "DEC/HEX/ASCII key sheet No." cannot be chosen.)
- When using the F930GOT-K, the key window and cursor are displayed or not displayed according to the combination of the settings made under "Basic" tab and here.
For details, refer to Section 7.6.3.
- When using the F920GOT-K, "Key window" settings are unavailable.

Serial communication setting screen

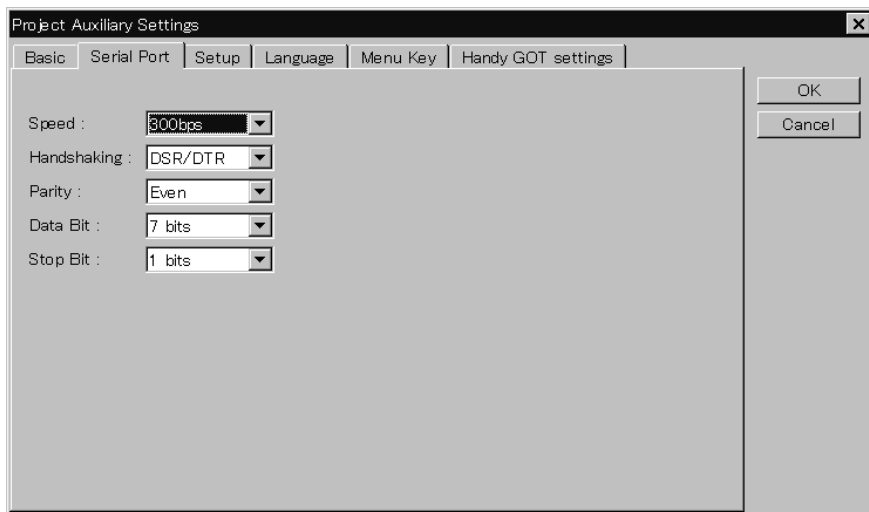

- This screen is used to make communication setting for connecting a printer or microcomputer to the GOT.
The items set on this screen are common setting for printer outputting (printing of sampling data in the sampling mode), printer output in the alarm mode and display screen hard copy.

Setup screen

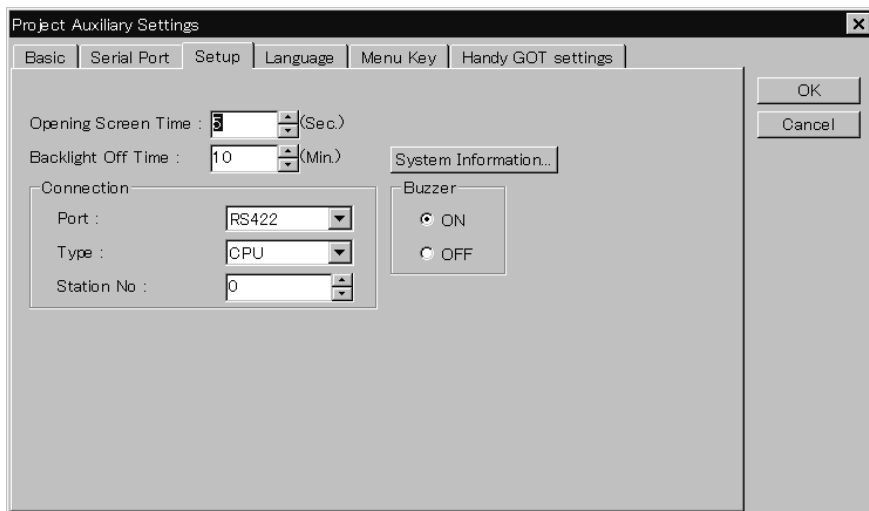

- This screen is used to set the opening screen time, backlight off time, connection system and buzzer ON/OFF.
- When using the F920GOT-K, "Key window" settings are unavailable.

Language setting screen

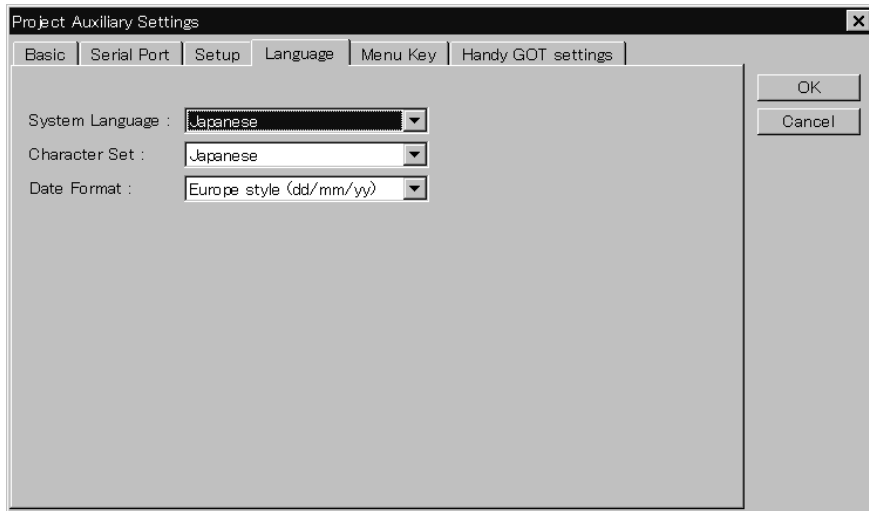

- This screen is used to select a language.
If a language other than "Japanese" is selected in "Character Set", "English" is fixed in "System Language".
If "West Europe" is selected in "Character Set", Italian, English, Dutch, Swedish, Spanish, German, Portuguese and French can be used.
Create screens using the screen creation software open on an OS (Windows) corresponding to the selected language.

Menu call key setting screen



- This screen is used to make a key setting for changeover from one of the screens in USER SCREEN MODE to a system screen.
When the picture of a key is clicked, the key is selected and "●" is displayed.
It can be cancelled by clicking on it again.
One or two keys can be selected. When two keys are selected, changeover to a system screen is performed by pressing the keys simultaneously.
- When using the F920GOT-K, "Menu Key" settings are unavailable.

Handy GOT settings screen

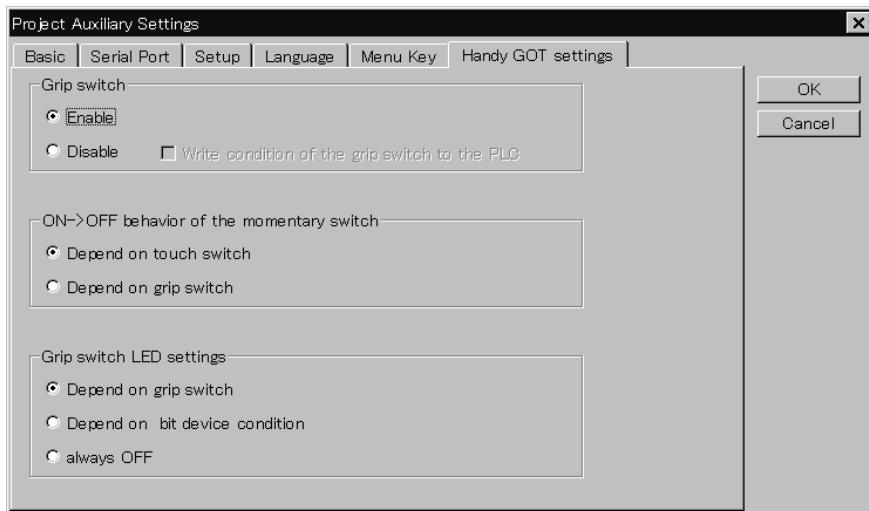

- In the case of GT Designer, settings specific to the Handy GOT can be made. "Grip switch Enable/Disable", "behavior of the momentary switch" and "Grip switch LED setting" are set on the screen shown above. The setting can be changed also on the GOT. When F920GOT-K, F930GOT-K, F93*GOT-K, F930GOT or F940WGOT are selected as the GOT type, the screen shown above cannot be displayed.

20.2 Parts list

This section describes the parts constructing user screens created using GT Designer. Created user screens are displayed in the screen mode described in Chapter 7. For specification of screens to be displayed, refer to Chapter 20. In the case of GT Designer, the parts comprising screens are referred to as "Figures" or "Objects".

◆Display example

The figures below show display examples of the screen. Only some objects are used in the examples below. Have in mind some objects are displayed on the screen and others are not.

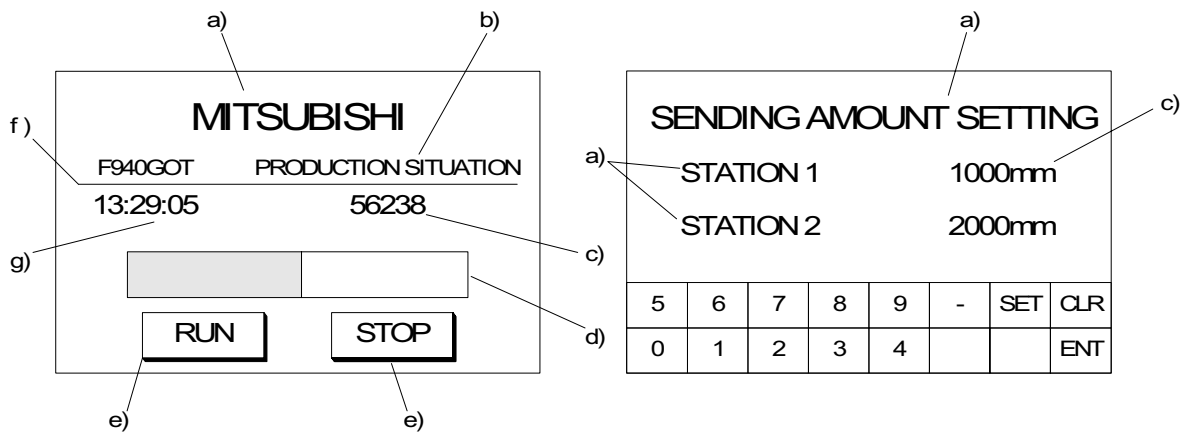

Figures: Display figures and characters in specified positions.

Figure	Description	Use example
Text	Displays characters such as alphabets, numerics and symbols.	a), b)
Line	Displays a straight line connecting specified two points.	f)
Rectangle	Displays a rectangle whose every edge is 90°. The rectangle can be filled.	
Circle	Displays a circle. The circle can be filled.	
Figure Data	Displays a figure in the BMP or DXF format.	

■Important point

Refer to detailed set items of each figure/object (Refer to the HELP file in the software file for the attributes.), then set each figure/object.

Objects: Display and allow to change the contents of devices in the PLC.

Function	Description	Use example
Numerical Display	Displays data stored in a word device in the form of numeric.	c)
Ascii Display	Regards the data stored in consecutive word devices as character codes (ASCII codes or shift JIS codes), and displays corresponding text.	-
Clock	Displays clock data stored in the GOT in the form of "time/date". In the F920GOT-K, clock data of the PLC is displayed. This function can be used only when connected to the PLC equipped with a clock function or either a memory cassette or memory board.	g)
Comment	Displays a comment in accordance with the ON/OFF status of a bit device or specified range of a word device. A displayed comment may occupy two or more lines.	-
Alarm History	Displays contents of the alarm history stored in the GOT.	-
Alarm List (user alarm)	Displays comments in accordance with bit devices in the ON status, in order of priority.	-
Part Display	Displays parts in accordance with the ON/OFF status of a bit device or the data of a word device. A BMP file format can be displayed as a part.	-
Lamp	Changes lighting color of a lamp in accordance with the data of a device.	-
Panelmeter	Displays data of a word device in the form of panel meter as a ratio against the minimum and maximum values.	-
Line	Acquires data stored in a word device at each specified timing, displays a line graph of the acquired data within the display range, then allows scroll of the line graph.	-
Trend	Acquires data of two or more word devices at a time, and displays the acquired data in the form of trend graph.	-
Bar	Displays data stored in two or more word devices in the form of bar graph.	d)
Statistics	Acquires data of two or more word devices, and displays the acquired data in the form of statistical graph indicating the ratio of the data of each word device against the entire data.	-
Touch Key	Turns on/off a bit device, allows to change the data of a word device or change the screen display when touched.	e)
Numerical Input	Writes an arbitrary numeric to a specified word device.	c)
Ascii Input	Writes an arbitrary character code to a specified word device.	-

20.3 Application and setting item

In some applications, two or more items (objects) are set.

Main applications and set items

Application	Set item (object name)		
Character display	Text		
	Comment display (word specification)	Comment List	
ASCII character display	ASCII display		
ASCII data input	ASCII input		
Numeric value display	Numerical display		
Numeric input	Numerical input		
Drawing (rectangle, circle, straight line)	Line, Rectangle, Circle		
Display of bit map file	Bit map		
	Part Display (word specification)	Parts	
	Part Display (fixed)	Parts	
Bit map file changeover display (bit device specification)	Part Display (bit specification)	Parts	
	Lamp (bit, object specification)	Parts	
Graphic display	Line graph Trend graph Bar graph		
	Rectangle graph Circle graph		
	Panel meter		
Display color reversing (bit device specification)	Lamp (Basic figure)		
Character display changeover (bit device specification)	Comment display (bit specification)	Comment List	
Screen overlay display (bit device specification)	No function (only ON or OFF can be set)		
Screen overlay display (word device specification)	Switching Screen Device (overlap window)		
Buzzer sound setting (bit device ON)	No function		
Date display	Clock (date)		
Time display	Clock (time)		

Application	Set item (object name)		
Display of touch key	Touch key		
Bit device ON/OFF *1	Key Action (Bit)		
Batch writing/reading of two or more data *1	Key Action (Bit) (read/write trigger)	Recipe	
Data increment *1	Key Action (Word) (fixed + indirect + initial value condition)		
Data decrement *1			
Ten-key keypad display (touch key specification)	No function		
Constant write (touch key specification) *1	Key Action (Word) (fixed value)		
Display screen changeover (touch key specification) *1	Key Action (Base switching)		
Display screen changeover (PLC specification)	Switching Screen (Base Screen)		
Display of alarm history	Alarm history	Alarm history (common setting)	Comment List
	Alarm history (system screen)	Switching Screen (The system screen number of changeover-to screen) should be specified.	
Display of alarm list	Alarm list	Comment List	
	Alarm history (system screen)	Switching Screen (The system screen number of changeover-to screen) should be specified.	
An alarm message is displayed while being shifted on the screen or two or more alarm messages are sequentially displayed.	Floating Alarm	Comment List	



*1 When using the key-pad on the F920GOT-K or F930GOT-K, set them under "Operation panel".

20.4 Figure display function

The table below shows the type and the attribute of figures to be displayed.

1) Available types

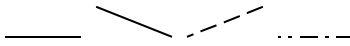
The table below shows the type of figures and characters.

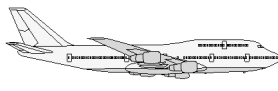
Figure	Display example	Available attributes
Line		Line Style and Line Color
Rectangle		Line Color and Foreground
Circle		
Figure data in BMP/DXF format	 This is a display example of a BMP file.	-
Text	ABC ABC abc abc	Character color, size and shift

1) Available attributes

The table below shows available attributes.

Attribute	Display example	
Line Style (Only continuous line is available for a circle.)	Continuous ————, Broken - - - - - , Dotted ······, Alternate long and short dash line — — — — —, Alternate long and two short dashes line — — — — —,	
Line Width	——— 1 dot	
Color	256 colors	
	Display status in GOT	F930GOT-BWD-E, F933GOT-BWD, F940GOT-LWD-E, F943GOT-LWD Any color other than black is displayed as white.
		F940GOT-SWD-E, F943GOT-SWD Displayed in 8 colors
Foreground		F940WGOT Displayed in 256 colors
	Display status in GOT	256 colors
		F940GOT-SWD-E, F943GOT-SWD Displayed in 8 colors
		F940WGOT Displayed in 256 colors

20.5 Data display function

The ON/OFF status of bit devices in the PLC and the current value of word devices in the PLC can be displayed.

20.5.1 Display of numerics

The "Numerical Display" object displays the data of word devices in the PLC in the form of numeric.

◆Contents of setting

1) Number of digits

- Maximum allowable number of digits: 12 (Minus sign (-) and decimal point are counted as digits.)

High-speed counter		C235 (32 bits)
-2147483648	to	2147483648
└──────────┘		└──────────┘
11 digits		10 digits

If data whose number of digits exceeds the maximum allowable number of digits is specified to be displayed, "?" is displayed.

Number of digits after decimal point (Decimal Point)

- Enter the number of digits after a decimal point for a case where a decimal point is displayed.

Example: When the displayed numeric is "2000"

2000: Number of digits after decimal point = 0

200.0: Number of digits after decimal point = 1

20.00: Number of digits after decimal point = 2

2.000: Number of digits after decimal point = 3

2) Format

- Select one style from decimal with sign, decimal without sign, hexadecimal, octal, binary and real (Binary float value).

- Zero suppression

When the zero suppression function is not used, "0" is displayed in each digit position to the left of the data. The number of "0"s will depend on the specified total number of digits.

Example:

When the total number of digits is set to 7 and the number of digits after decimal point is set to 2

0012.34



"0" is displayed.

- A numeric is displayed horizontally.

3) Layout

- When the number of digits to be displayed is smaller than the specified total number of digits, the numeric is automatically shifted to the right, the center or the left in accordance with the setting.

Example: When the specified total number of digits is set to 9 and the displayed numeric is a 3-digit value

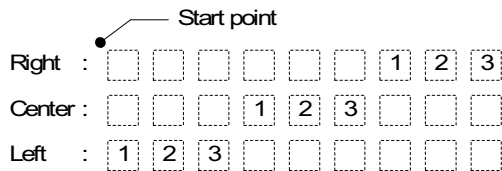

4) Gain 1, Gain 2 and Offset

The value obtained by the calculation "(Monitor value x Gain 1 / Gain 2) + Offset" is displayed.

Example: When the monitor value is 1000 (current value of D100), the Gain 1 is set to 10, the Gain 2 is set to 2 and the Offset is set to 3
 $(1000 \times 10 \div 2) + 3 = "5003"$ is displayed.

◆Display example

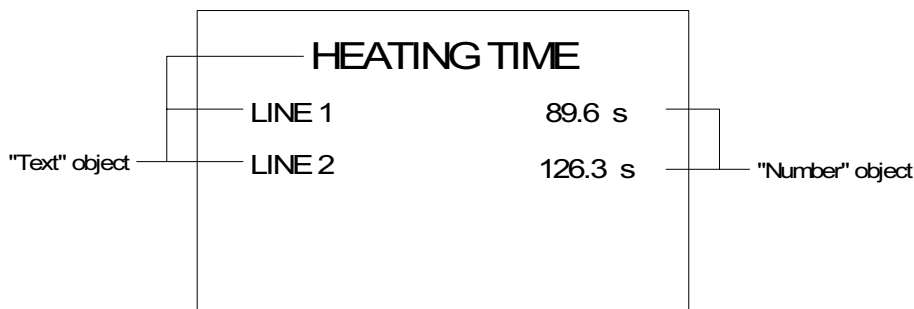

■Important point

- Display of numerics for timers and counters:
 When a device whose numeric is to be displayed is set to a timer or counter, its current value is displayed.
 To display the set value of a timer/counter, specify indirectly the set value of the timer/counter to be displayed as shown below, then display the value of the specified data register.

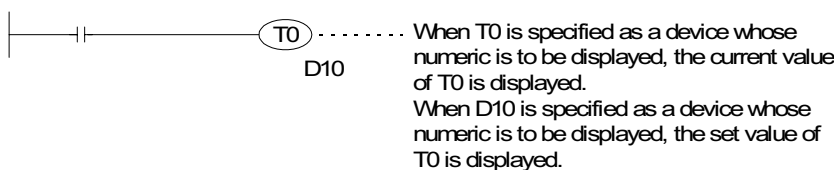

20.5.2 Ascii display

The "Ascii Display" object displays characters corresponding to specified word devices (T, C, D, V or Z) in the PLC.

Arbitrary characters can be displayed on one base screen.

◆Contents of setting

Alphabets, numerics, etc. which can be specified using ASCII codes.

◆How to specify character codes

- Reading the ASCII table

This section describes how to read ASCII using the Appendix as an example.

One ASCII character is displayed by combining both the vertical and horizontal axes.

.....The vertical axis shows the last digit of the code.

Example Select "A" Horizontal axis H40 Vertical axis 1 → ASCII H41 (hexadecimal expression)

Select "b" Horizontal axis H60 Vertical axis 2 → ASCII H62 (hexadecimal expression)

Higher Bit Lower Bit	1	2	3	4	5	6	7
0		(SP)	0	@	P	@	p
1		!	1	A	Q	a	q
2		"	2	B	R	b	r
3		#	3	C	S	c	s

◆Storage of word device

- Character codes are stored in PLC word devices. The stored data is displayed from the lower 8 bits as shown below.

Example 1 : When two characters (ASCII codes) are displayed
 Word Device : D0
 Data Length : 1



- A character to be displayed at first device should be specified using lower 8 bits.

■Important point

- When the character code is set to "H0", characters after that are not displayed on the screen.
 To insert space in a text, store "H20" to the specified word device.
- When connecting with the A Series PLC through a computer link or with the S7-200/300/400 Series from Siemens AG, ASCII codes are displayed from the left of the screen in order of upper eight bits to lower eight bits.
 Only when connecting with the A Series PLC through computer link, ASCII codes can be displayed from the left of the screen in order of lower eight bits to upper eight bits by changing the station number in "Project" – "Auxiliary Settings" – "Setup" – "Station #". Add 16 to the actual station number to effect the change. (For example: station # 3 becomes #19.)

◆Display example

"NORMAL" or "HIGH!!" are displayed as the "Ascii Display" objects using three data registers D100 to D102.

When X0 becomes ON, "NORMAL" is displayed.

When X1 becomes ON, "HIGH!!" is displayed.

- "Ascii Display" object (Specification example in the edit mode)
 - Character size : W: x2, H: x2
 - Character attribute : Rotate
 - Word device : D100
 - Data length : 3
- Display

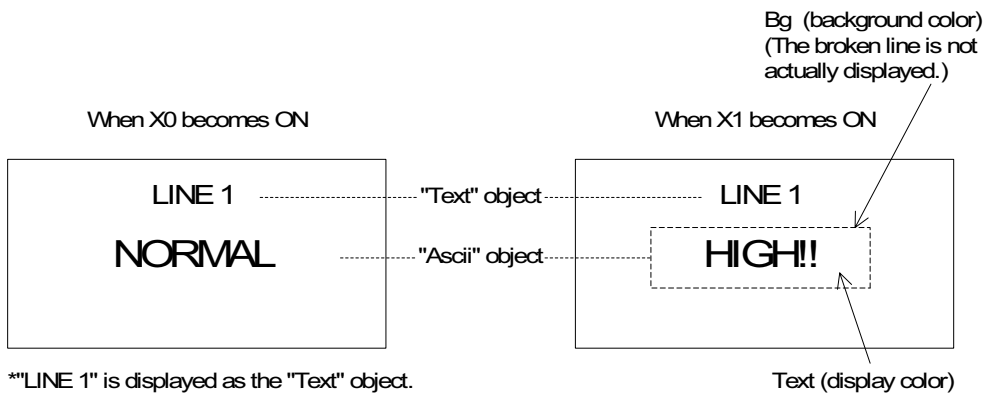

- Sequence program

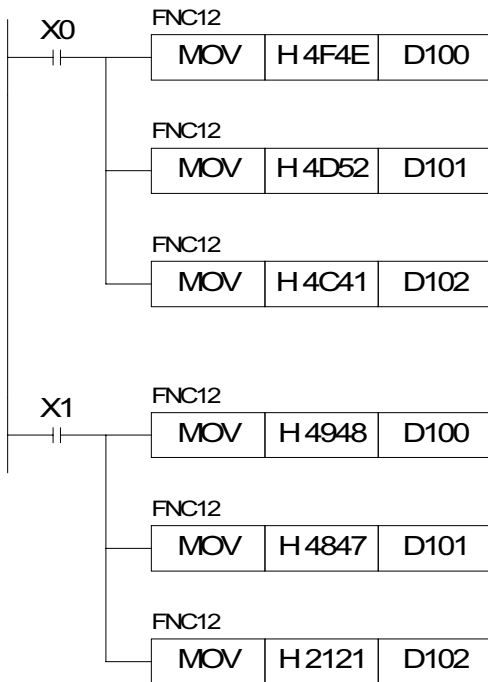

Storage status of data registers

	Upper	Lower	
D100	4F	4E	(H)
D101	4D	52	(H)
D102	4C	41	(H)

Storage status of data registers

	Upper	Lower	
D100	49	48	(H)
D101	48	47	(H)
D102	21	21	(H)

■Important point

The "Ascii Display" object displays specified texts on one screen as shown above. Accordingly, the screen is not required to be changed over nor overlay/be overlaid.

20.5.3 Clock display

The in-built clock in the GOT displays the date and time.

In the F920GOT-K, clock data of the PLC is displayed.

This function can be used only when connected to the PLC equipped with a clock function or either a memory cassette or memory board.

(Available only when connecting to the FX Series PLC)

◆Contents of setting

Date: YY/MM/DD

DD/MM/YY

MM/DD/YY(One of them can be selected.)

Time: HH:MM (fixed)

◆Display example

Date: 98/11/2 (YY/MM/DD)

2/11/98 (DD/MM/YY)

11/2/98 (MM/DD/YY)

Time: 16:28

■Important point

- Displayed date and time
The displayed date and time are equivalent to those set in the system settings in the GOT main body.
- When transmitting the current time data of the GOT to the PLC, use the observe status function (Refer to 16.8).

20.6 Message display function

20.6.1 Comment display

The "Comment" object displays specified texts in accordance with the ON/OFF status of a bit device (X, Y, M, S, T or C) in the PLC or the current value of a word device (D, T or C). Texts entered directly (available only for bit devices) or created in "Comment" in the screen creation software can be displayed.

◆Contents of setting

- 1) Specification method
 Bit device (X, Y, M, S, T or C)
 Word device (D, T, C or GD)
- 2) Display contents
 Bit device:
 Text to be displayed while a specified bit device is ON
 Text to be displayed while a specified bit device is OFF
 (Enter directly a text to be displayed. Or specify the comment number created in "Comment". Refer to Section 19.11)
 Word device:
 The comment number can be specified using the current value of a specified word device.
 Display color:
 Enter the color of text to be displayed.
 The color for the ON and the color for the OFF can be entered respectively.
 When the ON/OFF is not changed, the color set in the comment list is used.
 Creation of comment:
 A comment to be displayed in accordance with the specified comment number can be created in "Comment" in "Draw" of the screen creation software.

◆Display example

Comment	
Bit device	Y0
Comment No. for ON status	10
Comment No. for OFF status	11

COMMENT	
0	CHECK
...	...
9	MOTOR DRIVE
10	DRIVING
11	STOPPING
12	CYLINDER OFF
...	...

Comment No.
(Refer to Section 12.7.)

- PLC program



- GOT screen

While Y0 is ON
The comment No. 10 is displayed.

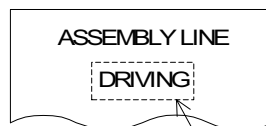

Display color (text color) and background color (The broken line is not actually displayed.)

Characters "ASSEMBLY LINE" are displayed using the "Text" object. On the same screen, displayed characters can be exchanged between "RUNNING" and "STOPPED".

While Y0 is OFF
The comment No. 11 is displayed.



- In the example above, comments registered in the comment list are displayed. Instead of entering the comment number, the text to be displayed in the ON/OFF status can be entered directly.
- When a word device is specified, the current value of the word device is regarded as the comment number to be displayed.

20.6.2 Alarm history display

When an alarm device set in the screen creation software becomes ON, a message corresponding to the alarm device as well as the date and time at which the alarm device became ON are displayed on a user screen. The date and time at which the alarm device became OFF can be also displayed.

◆Contents of setting

Attribute	Contents of setting
Common setting	Equivalent to the setting displayed in the alarm mode described in Chapter 6 Basic setting: Figure (with a frame), frame color, color inside frame and title color.
Display setting	Number of display lines (of alarm history), sort (from the oldest one/from the latest one), character size and recovery column (whether or not the recovery column is to be displayed)
Display format	Title (which may be changed) Width (display size in the horizontal direction: full-width x width) Color (The display color and title color are set in basic setting.) Contents (Date, time and characters can be specified.) Characters (to be displayed when characters are selected as contents)

◆Display example

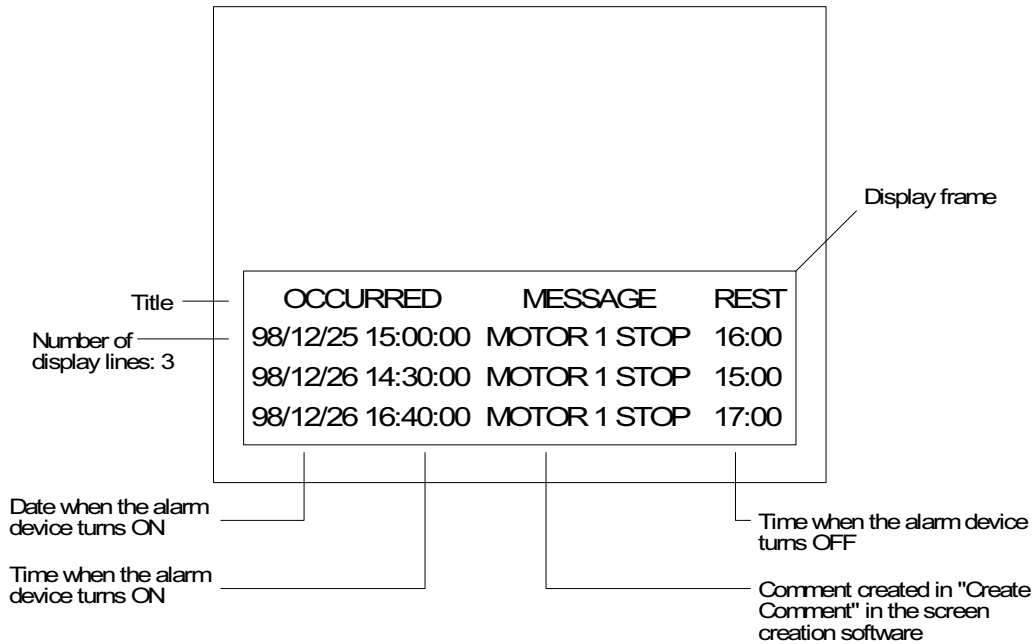

- The alarm device is selected for "Alarm History" under "Common".
- In the case of F940GOT, F943GOT with two-colored display (white/black), characters in each object of the alarm history display and alarm list display is displayed in black (characters in the cursor line is displayed in white). This means that only one line in which the cursor is located is legible if the screen color is black. When using these objects in F940GOT-LWD-E and F943GOT-LWD, the background color should be white. (In the case of GT Designer of SW3D5C-GOTR-PACKE(C) version or later, the screen background color can be changed.)
- When displaying Date and Time simultaneously in the F920GOT-K, only the combination of "mm/dd" and "hh:mm" is available.

- Combination of touch keys (Excluding F920GOT-K)
If touch key is placed on an alarm history screen and assigned a key code from the table below, it will perform its respective operation, also shown in the table.

Key codes used for the alarm history display function

Key code	Operation
FFB0	Displays the cursor.
FFB1	Deletes the cursor.
FFB2	Moves the cursor upward.
FFB3	Moves the cursor downward.
FFB6	Deletes the selected content of alarm.
FFB7	Deletes the content of all alarms.
FFB8	Displays the detailed information of the alarm selected by the cursor.

When a touch key to which "FFB8" (detailed information display function) is assigned, the alarm message (comment window) or the base screen is changed over, and the detailed information is displayed.

To display the detailed information, "Detail Display Destination" in "Alarm History Common Setting" of the screen creation software should be preliminarily set to "Comment Window" or "Base Screen".

- When "Comment Window" is selected

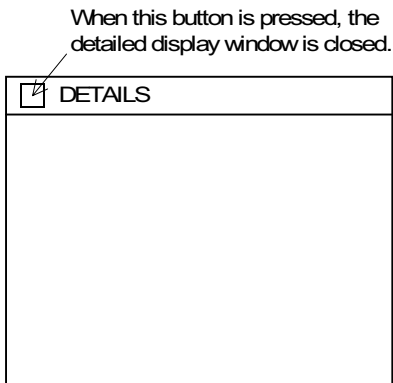

- Move the cursor to an alarm message to be displayed in detail, and press the DETAIL key. Then, the detailed display window opens as shown on the left.
- A comment in the comment list specified by "Detail Display No." in "Alarm History Common Setting" – "Device Monitor" – "Edit" of the screen creation software is displayed.

20.6.3 Alarm list display

When a specified device turns ON, a corresponding message is displayed. By using the alarm list display function, the setting different from that in the alarm mode described in Chapter 10 or in the alarm history display function can be performed.

◆Contents of setting

Attribute	Contents of setting
Basic setting	Figure (with a frame), frame color, color inside frame and display size
Display setting	Number of devices (When a device specified here turns ON, a corresponding message is displayed.) Storage of number of occurrences (The number of times a specified device turns ON can be stored in a word device.) Head comment number (number of comment created in "Comment" in the screen creation software) Number of displayed comments (When two or more comments are displayed, they are done so in ascending order of device number.) Display order (ascending/descending/from oldest/from latest) *1
Option	Detailed display (comment window/changeover of base screen) Save in memory (Even while the alarm list function is not displayed on the screen, the ON/OFF status of alarm devices can be acquired.)*2 Date/time display (The date/time when a specified device turns ON can be displayed.)*2

*1 Display order of "from oldest/from latest" is available for the following versions.
F930GOT-K, F930GOT, F933GOT: V4.10, F940GOT, F943GOT: V6.10,
F940WGOT: V1.10 or later
Only ascending/descending order settings are valid in the F920GOT-K.

*2 Unavailable in the F920GOT-K

◆Display example

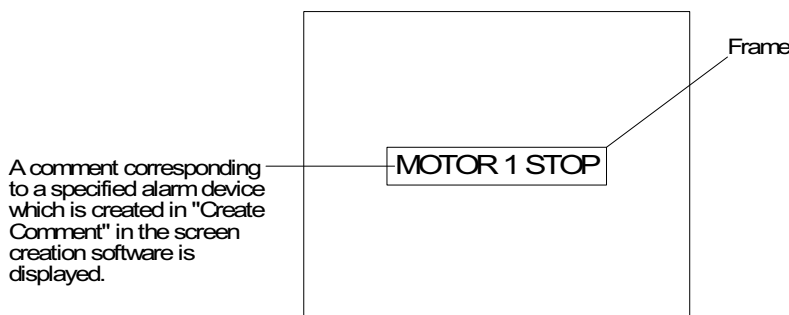

- In the case of F940GOT, F943GOT with two-colored display (white/black), characters in each object of the alarm history display and alarm list display is displayed in black (characters in the cursor line is displayed in white). This means that only one line in which the cursor is located is legible if the screen color is black. When using these objects in F940GOT-LWD-E and F943GOT-LWD, the background color should be white. (In the case of GT Designer of SW3D5C-GOTR-PACKE(C) version or later, the screen background color can be changed.)

- Combination of touch keys (Excluding F920GOT-K)
If a touch key on the alarm list is assigned with a key code from the table below, it will perform its respective operation, also shown in the table.

Key codes used for the alarm list display function

Key code	Operation
FFB0	Displays the cursor.
FFB1	Deletes the cursor.
FFB2	Moves the cursor upward.
FFB3	Moves the cursor downward.

When a touch key to which "FFB8" (detailed information display function) is assigned, the alarm message (comment window) or the base screen is changed over, and the detailed information is displayed.

To display the detailed information, "Detail Display Destination" in "Alarm List Display Setting" of the screen creation software should be preliminarily set to "Comment Window" or "Base Screen".

- When "Comment Window" is selected

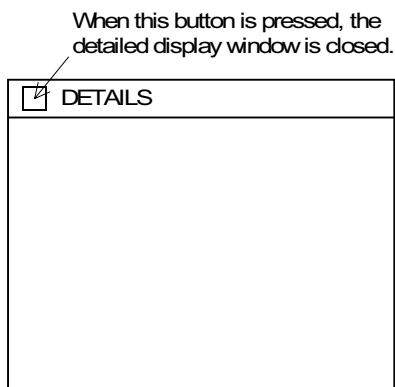

- Move the cursor to an alarm message to be displayed in detail, and press the DETAIL key. Then, the detailed display window opens as shown on the left.
- A comment in the comment list specified by "Detail Display No." in "Alarm List Display Setting" – "Detail Display Setting" of the screen creation software is displayed.

- Changeover of the base screen
A screen specified by "Detail Display No." in "Alarm List Display Setting" – "Option" of the screen creation software is displayed.

20.7 Animation display function

20.7.1 Part display

The "Part Display" object can display figures registered in "Part" in accordance with the ON/OFF status of bit devices in the PLC and the current value of word devices in the PLC.

◆Contents of setting

1) Specification method

- Bit device
- Word device

2) Contents of display

Bit device:

- Part number of a figure to be displayed while a specified bit device is ON
- Part number of a figure to be displayed while a specified bit device is OFF

Word device:

- Part number of a figure which is equivalent to the current value of a specified word device

Creation of figures to display:

- Figures can be created and registered using the screen creation software.
- Figures can be stored in BMP files, etc.

◆Display example

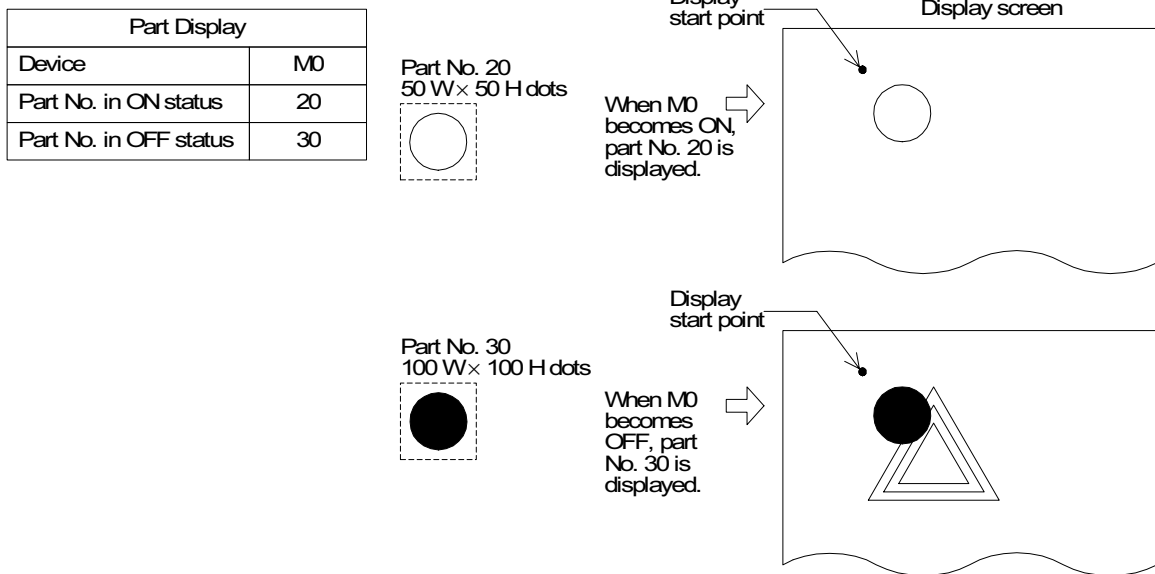

- The specified part is displayed in the same size as registered in the screen creation software.

20.7.2 Lamp

The "Lamp" object changes over the displayed figure in accordance with the ON/OFF status of a specified bit device in the PLC.

By using the lamp display function, figures built in the screen creation software can be displayed.

◆Contents of setting

- 1) Specification method
Bit device
- 2) Contents of display

Bit device : Figure to be displayed when a specified bit device becomes ON
 Figure to be displayed when a specified bit device becomes OFF

Displayed figure: Register a figure to be displayed using the screen creation software.
 A figure can be selected only among figures built in the screen creation software.

Text : Text can be displayed inside a figure.

Color : The text, frame and background color can be specified.

◆Display example

When a bit device is specified

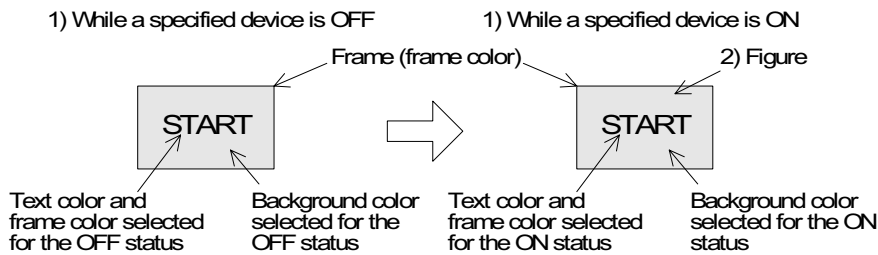

■Important point

Display of figures created by the user

To display figures created by the user, use the part display function described in the previous section.

20.7.3 Panel meter

The "Panelmeter" object displays the current value of a word device in the form of panel meter.

◆Contents of setting

- 1) Specification method
16-bit or 32-bit word device
 - 2) Contents of display
Meter type :Circle (perfect circle, half circle, 1/4 and 3/4 display available)
Number of ticks :Ticks are provided on the panel meter.
Color :The meter needle color, the frame color, etc. can be specified.
- The meter needle is moved clockwise.

◆Display example

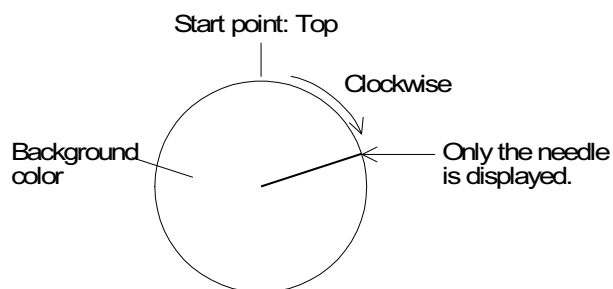

20.8 Graph display function

Specified word devices can be displayed in the form of graph.

- Line graph: Section 20.8.1
- Trend graph: Section 20.8.2
- Bar graph: Section 20.8.3
- Statistics graph (Rectangle graph and Circle graph) : Section 20.8.4

Line graph, Trend graph, and Statistics graph (Rectangle graph and Circle graph) are not available in the F920GOT-K.

20.8.1 Line graph

The "Line" object displays the current value of consecutive word devices in up to four lines. (Unavailable in the F920GOT-K.)

◆ Contents of setting

Attribute	Contents of setting
Display direction	Right or left
Number of lines	1 to 4
Number of points	1 to 50
Monitored devices	16-bit or 32-bit word devices
Line type	—————, - - - - - , - . - . - , — . - . - , — . - . - .
Color	Graph color, frame color, scale color

◆ Display

The current value of word devices as well as a certain amount of historical data is displayed in the form of a trend graph.

The number of word devices shown at each tick is equivalent to the specified number of lines.

Assignment of word devices to points in line graph

Word device	D	D + 1	D + 2	D + 3	D + 4	D + 5	D + 6	D + 7
Data number	No.1				No.2			
Tick in horizontal axis	1st tick	2nd tick	3rd tick	4th tick	1st tick	2nd tick	3rd tick	4th tick

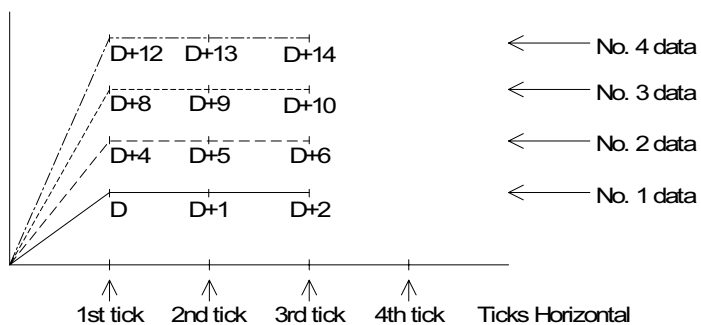

20.8.2 Trend graph

The "Trend" object acquires the current values of up to four 16-bit data registers in the PLC at a specified time interval, and displays the acquired data in the form of line graph.
(Unavailable in the F920GOT-K.)

◆Contents of setting

Attribute	Contents of setting
Display direction	Right or left
Number of lines	1 to 4
Number of points	1 to 50
Monitored devices	16-bit or 32-bit word devices
Line type	_____, _____, _____, _____, _____
Color	Graph color, frame color, scale color
Display condition	Constant cycle (which can be set arbitrarily in the unit of 100 ms)

◆Display example

"Trend Graph" object		
Word Device	D100	
Display condition	30	
Ticks Horizontal	10	
Ticks Vertical	7	
Minimum Value	0	
Maximum Value	1000	
Shown Device	No. 1	Continuous Red
	No. 2	Dotted Blue
	No. 3	None
	No. 4	None
Scale Color: Black		

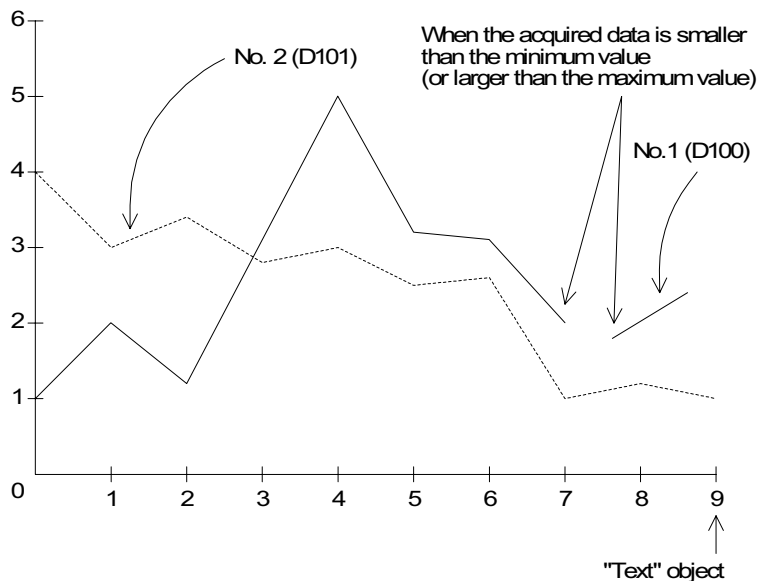

- Word devices D100 and D101 are acquired every 3 seconds, and displayed in the form of line graph.
- If the acquired data is smaller than the minimum value (0) or larger than the maximum value (1000), it is not displayed in the graph and the graph is discontinued.

■Important point

Sampling time

It is recommended to set the sampling time to 1 second or more.

In the sampling cycle, the GOT reads the bit device set in "Clear Trigger".

Set the bit device in "Clear Trigger" be ON and OFF in a longer period than the sampling cycle.

20.8.3 Bar graph

The "Bar" object displays a word device in the PLC in the form of bar graph. A numeric which is rather difficult to understand in the form of number can be displayed in the form of bar graph so that it can be easily understood at a glance.

◆Contents of setting

Attribute	Contents of setting
Display direction	Horizontal or vertical
Monitored devices	Word devices
Number of ticks	2 to 11
Color	Graph color, frame color, scale color

1) Graph type

- Bar graph type: Horizontal (left to right) or vertical (bottom to top)
- The entered minimum value is regarded as 0%, and the entered maximum value is regarded as 100%. The acquired data is represented in % against 100%.
If the acquired data is larger than the maximum value or smaller than the minimum value, a diagonal line is drawn in the bar graph.

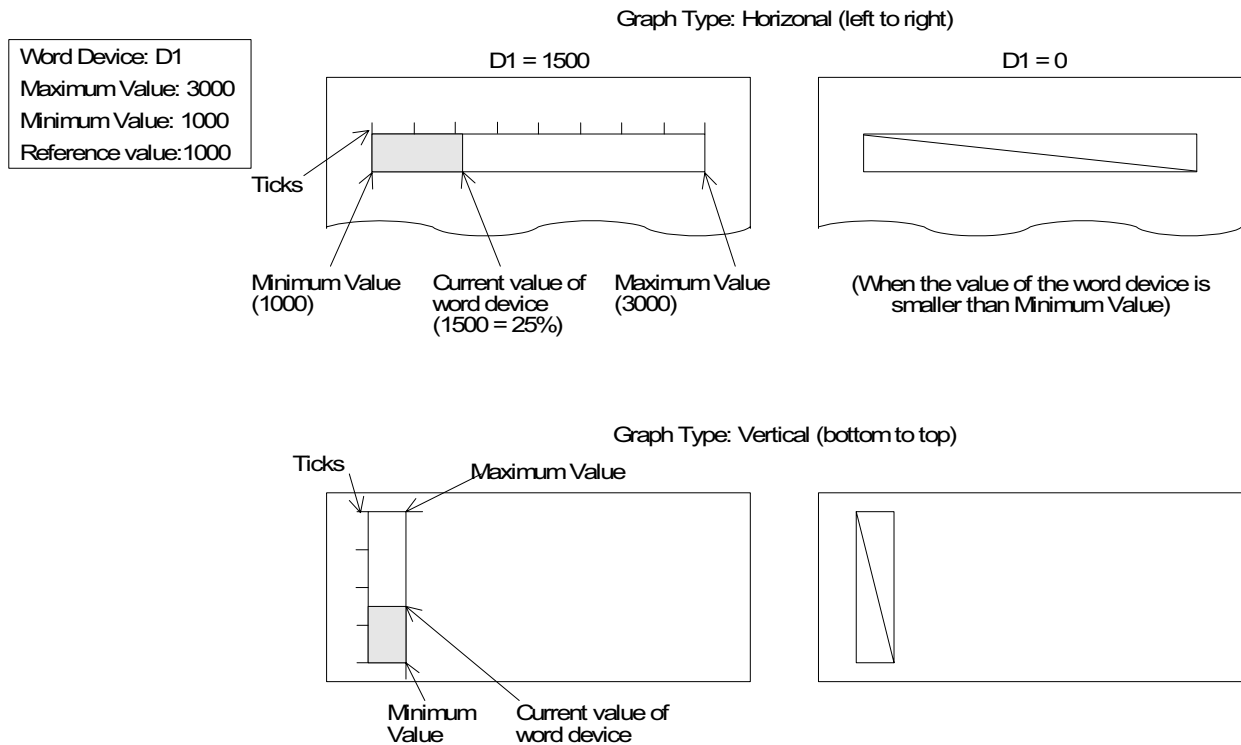

The bar graph is displayed from the specified reference value position.

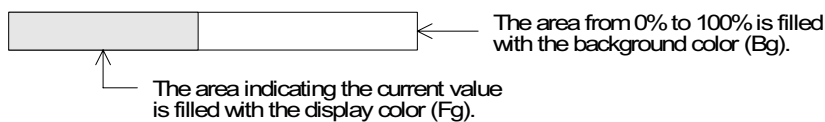

2) Number of ticks and scale position

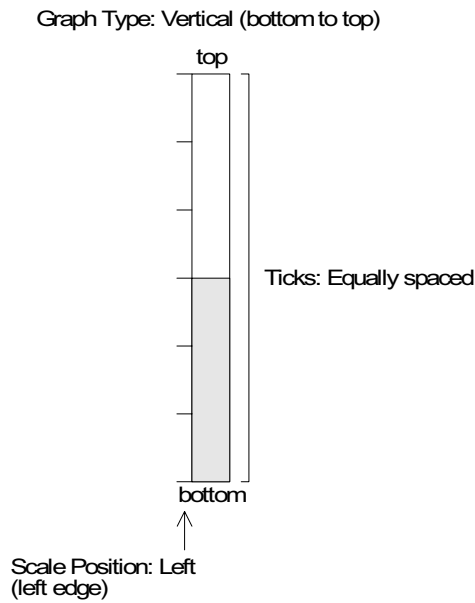
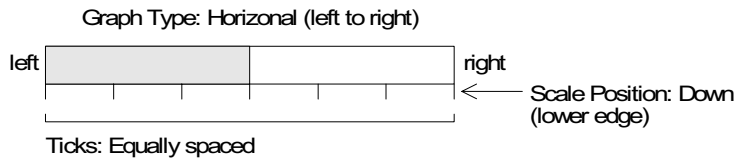

◆ Display example

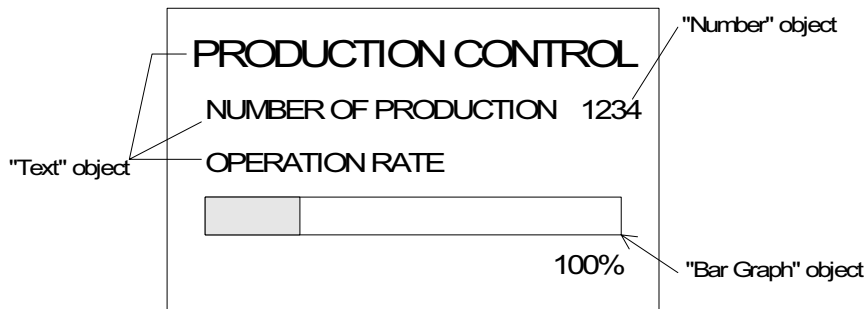

20.8.4 Statistics graph display function

The "Statistics" object displays the current value of specified word devices in the form of a statistical bar graph or pie graph as a ratio against 100%.
(Unavailable in the F920GOT-K.)

◆Contents of setting

Attribute	Contents of setting
Graph type	Bar graph or pie graph
Monitored devices	Word device
Color	Graph color and scale color

◆Display example

Setting example: Rectangle graph

Head word device : D100

Number of devices : 6

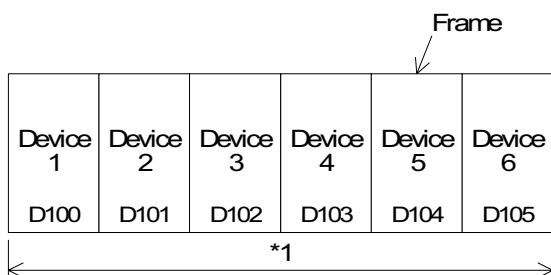

*1 The specified width is regarded as 100%. The ratio of the current value of each device is displayed in %.

Setting example: Circle graph

Head word device : D200

Number of devices : 3

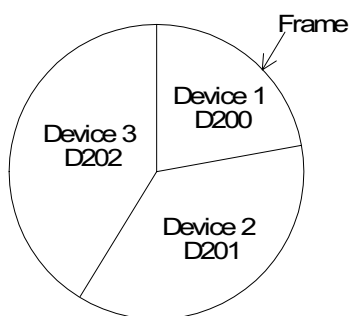

A point located at the top of the circle is regarded as the start point. From the device 1 (D200 in this example), each device is displayed clockwise.
"360°" is regarded as 100%. The ratio of the current value of each device against 100% is represented.

20.9 Touch keys

- Touch keys offer the following functions

Function	Description	Reference chapter/section
Bit function	Turns on/off a bit device when touched.	19.9.2
Word function	Allows to change the value of a word device when touched.	19.9.3
Base screen changeover function	Changes over the base screen when touched.	20
Numerical/ASCII input key creation function	Allows to create keys to enter numerics and ASCII codes.	19.9.4

- Two or more functions shown above can be assigned to one touch key. In such a case, the priority is given to the assigned functions as follows.

Contents of function	Quantity	Priority given when two or more functions are assigned
Bit momentary	20	Highest priority ↓ Lowest priority
Bit SET	20	
Bit RST	20	
Bit ALT	20	
Word SET	20	
Base screen changeover	1	
-	50 maximum	

- A touch key is unavailable in the F920GOT-K.

20.9.1 Common items for all touch keys

This section describes the common contents shared by each function assigned to touch keys.

1) Size (Example of F940GOT)

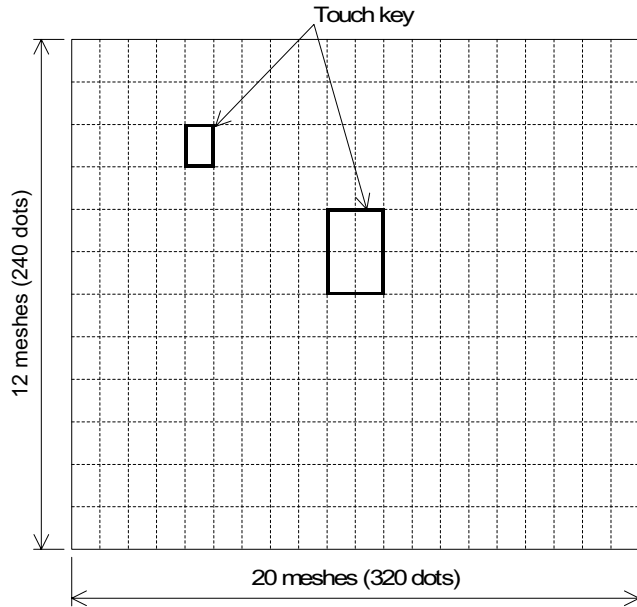

- The entire screen is divided into "meshes" as shown on the left. The touch key area can be specified in the unit of mesh.
- The meshes and matrix configuration of each GOT is as follows. (One mesh consists of 16 × 20 dots.)
 F930GOT, F933GOT:
 15 (horizontal) × 4 (vertical)
 F940GOT, F943GOT:
 20 (horizontal) × 12 (vertical)
 F940WGOT:
 30 (horizontal) × 12 (vertical)
 Last column composed of 14 dots
- Broken lines are not actually displayed on the screen.

- A touch key can be set in the unit of dot. When more than a half of a mesh is set as a touch key, the mesh is recognized as the touch key.

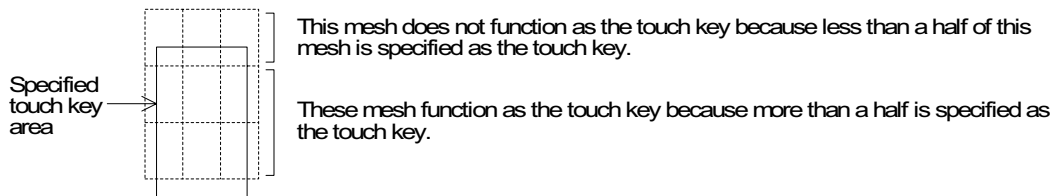

2) Display changeover

Key : When a specified position is touched, the display frame, text and color can be changed.

Bit : When a specified bit device becomes ON or OFF, the display frame, text and color can be changed.

3) Figure

- Select whether or not the area specified as the touch key is enclosed with a frame.
- Select "No frame" or one among the 18 types of frames (5 types for GT Designer earlier than SW3D5C-GOTR-PACKE(C)).

Frame shape						
	No frame	Shaded	Double frame (keyboard)	Double frame (trimming)	Double frame (shaded)	Double frame (bold)

- By turning on/off the touch key, the displayed figure and color can be specified.

4) Text

Enter text to be displayed inside the touch key.
Up to 40 characters can be displayed.

<Display example>

-In the case of 1 line



When text is located in the center

-In the case of 2 lines

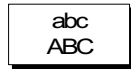

When the first line is blank, text is displayed in the second line

-In the case of 3 lines

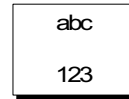
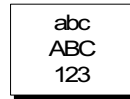

When the second line is blank, texts is displayed in the first and third lines respectively

If text is longer than the touch key, the text is extruded.



When text is displayed in 1 line

5) Operation setting

- Bit function : When a touch key is pressed, a specified bit device is turned ON or OFF. (Section 20.9.2)
- Word function : When a touch key is pressed, the current value of a specified word device can be changed. (Section 20.9.3)
- Base switching function: When a touch key is pressed, the display screen is changed over. (Chapter 21)

6) Simultaneous press

Set whether or not a touch key is effective when it is pressed simultaneously together with another touch key.

Three or more keys cannot be made effective when pressed simultaneously.

7) Trigger

Always : A touch key always offers the assigned functions.

ON : While a specified bit device is ON, a touch key offers the assigned functions.

OFF : While a specified bit device is OFF, a touch key offers the assigned functions.

20.9.2 Bit function

Bit function allows a touch key in the GOT to control the ON/OFF status of a bit device in the PLC.

The bit function allows a touch key to act as a switch such as a push button switch.

◆Contents of setting

1) Operation mode

- Select one among the following output operation modes.

Bit momentary : Turns on/off the controlled bit device in accordance with the ON/OFF status of the control input key.

Bit ALT : Turns on/off the controlled bit device every time the control input key becomes ON from OFF (alternate type switch).

Bit SET : Forces ON the controlled bit device when the control input key becomes ON. The controlled bit device remains ON until a reset input is given.

Bit RST : Forces OFF the controlled bit device when the control input key becomes ON.

Operation examples of "Momentary" and "Bit ALT"

When a touch key is pressed, Y0 in the PLC is output.

- Switch Control input: Touch key
Controlled bit device (output): Y0

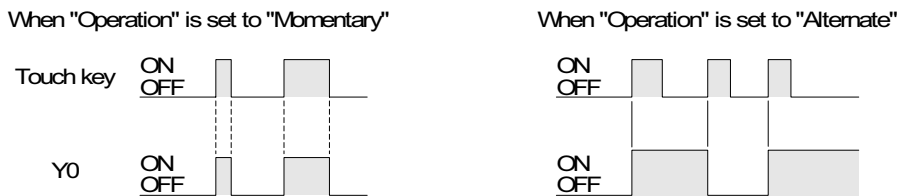

Operation examples of "Bit SET" and "Bit RST"

When the SET key is pressed, Y1 is set. When the RST key is pressed, Y1 is reset.

- Switch Control input: SET key, RST key
Controlled bit device (output): Y1 (set), Y1 (reset)

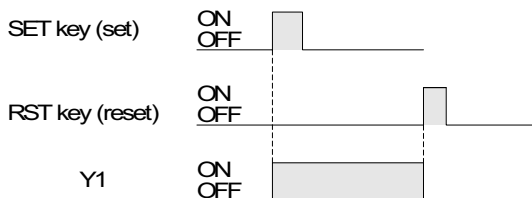

■Important point

- 1) Controlled bit device:
If "Operation" is set to "Momentary", the controlled bit device becomes OFF when the display screen is changed over.
- 2) If two or more keys are pressed simultaneously:
If two or more switch functions are registered, and two keys are pressed, both functions will be executed.
If three or more keys are pressed simultaneously, only the first two pressed will be effective.
- 3) If objects are assigned to one touch key:
If two or more switch functions are assigned or another object is assigned to one touch key, the priority is given to a function/object registered first (while the screen is created).
- 4) If screens are overlaid:
If screens are overlaid using control devices or screen call function, the switch functions are effective on all of the base screen and overlaying screens. If switches are overlaid, the switch on the top screen is effective. Pay rigid attention so that switches are not overlaid.

Example

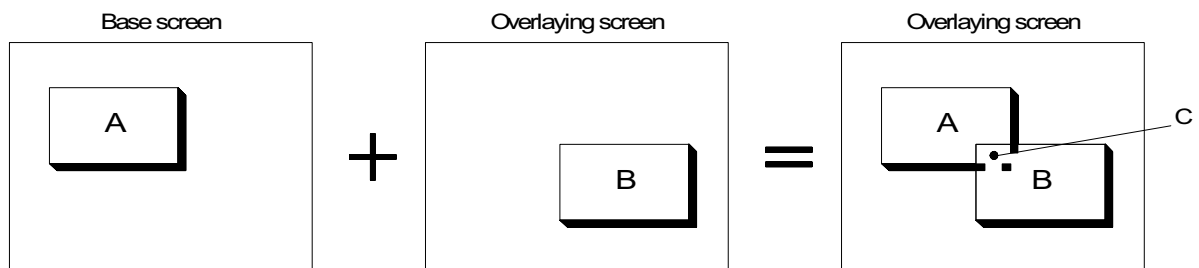

In the switch areas A and B on the composed screen realized by overlay, each switch is effective. However, if the area C is pressed, the switch B located on the top is effective.

- 5) Caution on connecting the SYSMAC C Series manufactured by OMRON
Using a forced set/reset by peripheral equipment in the SYSMAC C Series PLC locks the PLC bit devices into their current state. This state cannot be changed by the PLC program. In the above described situation, using the switch function in USER SCREEN MODE or forced ON/OFF function in HPP MODE in the GOT will have the following consequences.
 - a) If a bit device is turned ON/OFF in the GOT, all the bit devices are released to change state by the PLC program. (GOT uses the KC command)
F930GOT or F933GOT: prior to Version 4.40; F940GOT or F943GOT: prior to Version 6.40;
F940WGOT: prior to Version 1.40
 - b) Only the device turned ON/OFF in the GOT is released to change state by the PLC program. (GOT uses the FK command)
F930GOT or F933GOT: Version 4.40 or later; F930GOT-K: First product,
F940GOT or F943GOT: Version 6.40 or later; F940WGOT: Version 1.40 or later

20.9.3 Word function

The word function writes a fixed constant to the PLC when a touch key is pressed. The word function is convenient: When it is used, sequence programs such as transfer instructions are not required.

◆Contents of setting

Attribute	Contents of setting
Word device	
Operation type	Fixed value (A specified constant is written to a word device.) Indirect (The current value of a specified word device is written.)

■Important point

- 1) Write of a constant to a timer/counter:
 Even if "0" is written to the current value or set value of a timer/counter, the output contact in the PLC is not reset. (Though the current value or set value becomes 0, the output contact does not become OFF.)
 To reset a timer/counter, execute an RST instruction in the sequence program or reset the timer/counter using a bit function.
- 2) Constant write condition
 "✓" indicates that write of constant is enabled.

PLC	FX Series	A Series
PLC memory type	✓:RAM ×:EPROM *1 ×:EEPROM *1 When the read/write destination is a data register, data can be transferred without regard to the memory type.	✓:RAM ✓:EPROM
PLC operation status	✓:RUN ✓:STOP	✓:RUN ✓:STOP
GOT memory type	✓:Flash memory	✓:Flash memory
PLC entry code	×: While entry code is registered (while write is forbidden) ✓: While entry code is unlocked or is not registered	×: While entry code is registered (while write is inhibited) ✓: While entry code is unlocked or is not registered

20.9.4 Creation of keys to enter numerics and ASCII codes

This function sets touch keys as keys to enter numeric and ASCII codes.

◆Contents of setting

Key code: Refer to the key code list shown in the appendix.

- When a key code shown in the appendix is assigned to a touch key, a corresponding numeric or alphabet (ASCII code) can be entered.
- When entering ASCII codes, touch keys to which key codes are assigned should be laid out to create the keyboard.

20.10 Operation panel

When using the function keys in the F920GOT-K and the F930GOT-K, assign an operation to each key by setting "Operation Panel" in "Common".

- The settings of the function keys are handled in the unit of project. (The function keys cannot be set for each screen.)
- Key codes cannot be assigned to function keys.
- "Operation Panel" has the following functions:

Function	Description	Reference section/ paragraph
Bit function	Turns ON or OFF the bit device when touched.	20.9.2
Word function	Changes the value of the word device when touched.	20.9.3
Base switching function	Switches the base screen when touched.	21

- Two or more functions above can be set to one touch key. The priority of the function execution is determined as follows:

Description of function	Quantity	Operation execution order when two or more functions are set
Bit momentary	20	Highest priority ↓ Lowest priority
Bit set	20	
Bit reset	20	
Bit alternate	20	
Word set	20	
Base screen switching	1	
—	50 maximum in all	

20.10.1 Assignment of function keys

In the F920GOT-K, the function keys are assigned as X000, X001, ... X005 from the left.
 In the F930GOT-K, the function keys are assigned as X000, X001, X002 and X003 from the left to the right in the upper row, and as X004, X005, X006 and X007 from the left in the lower row.

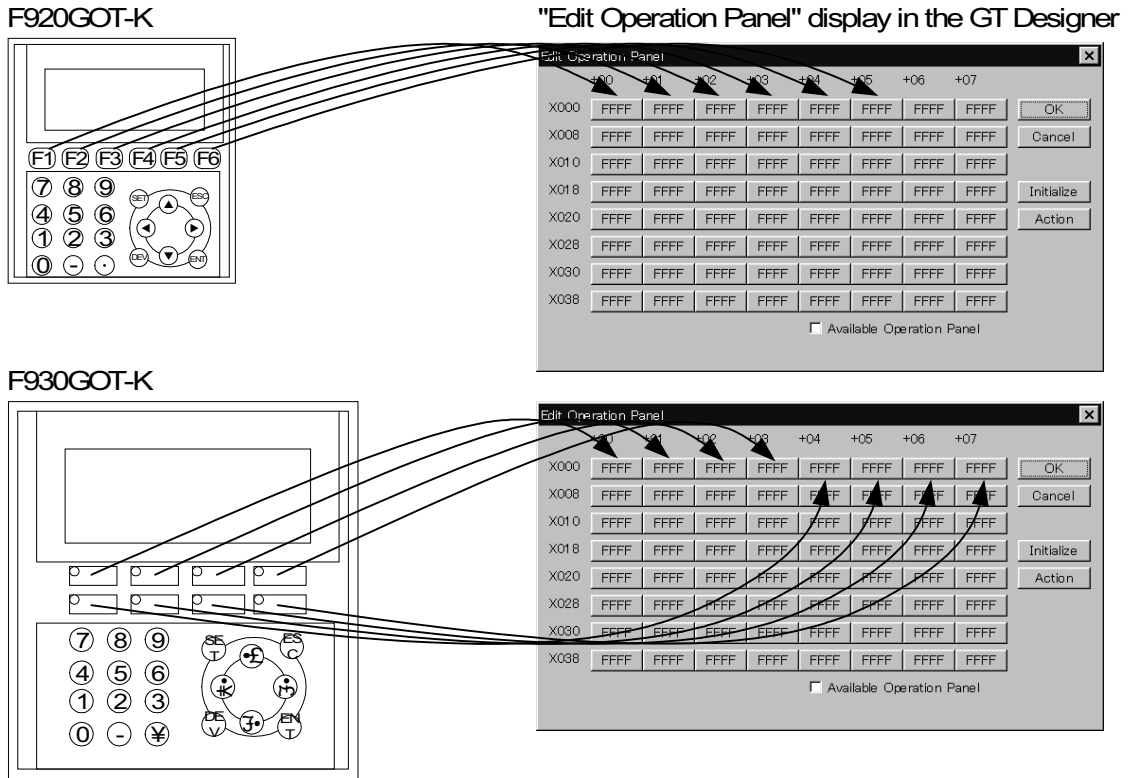

20.11 Data input function

The ON/OFF status of bit devices and the current value of word devices in the PLC can be displayed.

20.11.1 Numerical input function

The data of word devices in the PLC can be displayed in the form of numerics.

◆Contents of setting

1) Number of digits

- Maximum allowable number of digits: 12 ("-"(minus signs) and decimal points are counted as digits.)

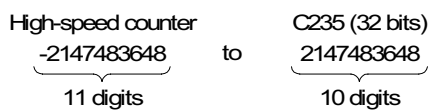

If data whose number of digits exceeds the maximum allowable number of digits is specified to be displayed, "?" is displayed.

Number of digits after decimal point (Decimal Point)

- Enter the number of digits after a decimal point for a case where a decimal point is displayed.

Example: When the displayed numeric is "2000"

- 2000 : Number of digits after decimal point = 0
- 200.0 : Number of digits after decimal point = 1
- 20.00 : Number of digits after decimal point = 2
- 2.000 : Number of digits after decimal point = 3

- Install the touch key which allocates key code (002E) when you input the decimal point by the numeric input operation.(Refer to 7.5.2 for details.)

2) Format

- Select one style among decimal with sign, decimal without sign, hexadecimal, octal, binary and real (Binary float value).

- Zero suppression

When the zero suppression function is not used, "0" is displayed in each digit position to the left of the data. The number of "0"s will depend on the specified total number of digits.

Example:

When the total number of digits is set to 7 and the number of digits after decimal point is set to 2

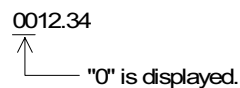

- A numeric is displayed horizontally.

3) Layout

- When the number of digits to be displayed is smaller than the specified total number of digits, the numeric is automatically shifted to the right, the center or the left in accordance with the setting.

Example:

When the specified total number of digits is set to 9 and the displayed numeric is a 3-digit value

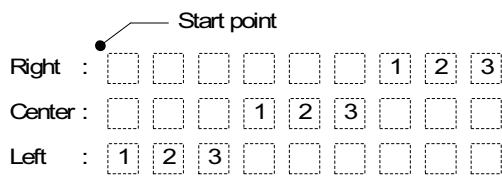

4) Gain 1, Gain 2 and Offset

The value obtained by the calculation "(Monitor value x Gain 1 / Gain 2) + Offset" is displayed.

Example:

When the monitor value is 1000 (current value of D100), Gain 1 is set to 10, Gain 2 is set to 2 and the Offset is set to 3

$(1000 \times 10 \div 2) + 3 = "5003"$ is displayed.

When entering numeric values, the result obtained by the calculation " $[(\text{Input value}) - \text{Offset}] / \text{Gain 1} \times \text{Gain 2}$ " is stored in the word device.

5) Upper, Lower

Specifies the input range of numeric value.

6) User ID

An ID can be assigned to the numerical input function.

When device data specified by the "Numerical Input" object is changed (by pressing the ENT key), ID No. is stored in the write device "DO+3" in the system information. By checking this ID No., the changed "Numerical Input" object can be detected.

Make sure to assign an ID different from other numerical inputs ID's.

7) Destination ID

This attribute allows to specify the change order of "Numerical Input" objects.

20.11.2 Ascii code input function

The "Ascii Input" object displays characters corresponding to specified word devices (T, C, D, V or Z) in the PLC. Arbitrary characters can be displayed and changed on one base screen. Only [0] to [9], [-] and [•] are available in the F920GOT-K. When using the F930GOT-K, [0] to [9], [-] and [•] can be entered using the key-pad. Use the key window to enter other characters.

◆**Contents of setting**

Alphabets, numerics, etc. which can be specified using ASCII codes.

◆**How to specify character codes**

- Reading the ASCII table
 One ASCII character is displayed by combining both the vertical and horizontal axes.
The vertical axis shows the last digit of the code.

Example Select "A" Horizontal axis H40 Vertical axis 1 → ASCII H41 (hexadecimal expression)
 Select "b" Horizontal axis H60 Vertical axis 2 → ASCII H62 (hexadecimal expression)

Higher Bit Lower Bit	1	2	3	4	5	6	7
0		(SP)	0	@	P	@	p
1		!	1	A	Q	a	q
2		"	2	B	R	b	r
3		#	3	C	S	c	s

◆Storage of word device

- Character codes are stored in PLC word devices. The stored data is displayed from the lower 8 bits as shown below.

Example 1 : When two characters (ASCII codes) are displayed
 Word Device : D0
 Data Length : 1

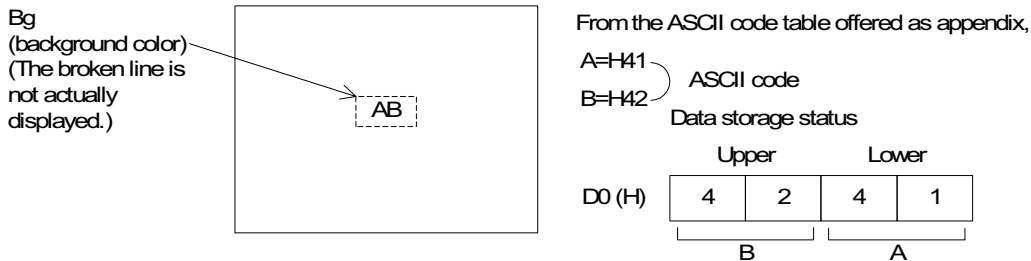

- A character to be displayed first should be specified using lower 8 bits.

■Important point

- When the character code is set to "H0", characters after that are not displayed on the screen.
 To insert space in a text, store "H20" to the specified word device.
- When connecting with the A Series PLC through a computer link or with the S7-200/300/400 Series from Siemens AG, ASCII codes are displayed from the left of the screen in order of upper eight bits to lower eight bits.
 Only when connecting with the A Series PLC through computer link, ASCII codes can be displayed from the left of the screen in order of lower eight bits to upper eight bits by changing the station number in "Project" – "Auxiliary Settings" – "Setup" – "Station #". Add 16 to the actual station number to effect the change. (For example: station # 3 becomes #19.)

◆Display example

"NORMAL" or "HIGH!!" are displayed as the "Ascii Display" objects using three data registers D100 to D102.

When X0 becomes ON, "NORMAL" is displayed.

When X1 becomes ON, "HIGH!!" is displayed.

- "Ascii Display" object (Specification example in the edit mode)
 - Character size : W: x2, H: x2
 - Character attribute : Rotate
 - Word device : D100
 - Data length : 3
- Display

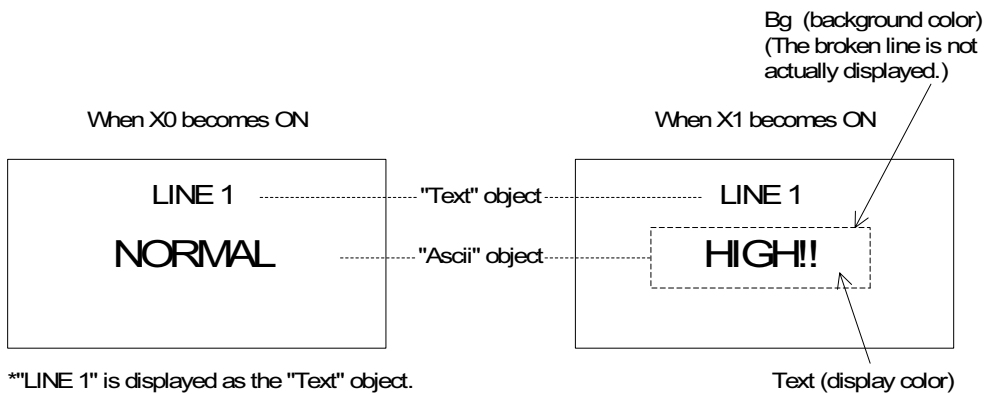

- Sequence program

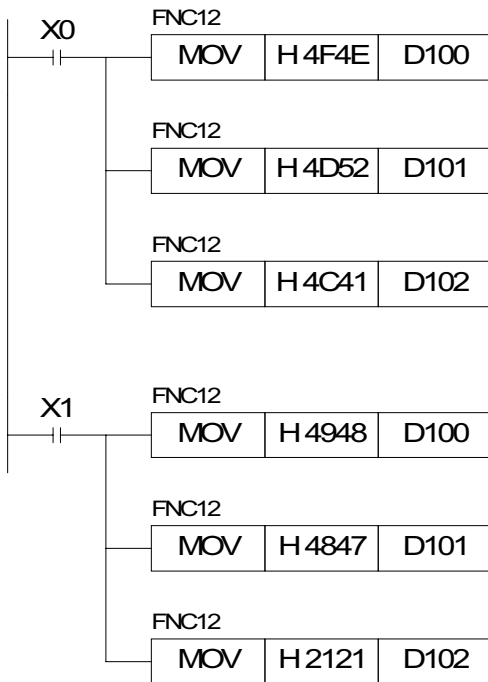

Storage status of data registers

	Upper	Lower	
D100	4F	4E	(H)
D101	4D	52	(H)
D102	4C	41	(H)

Storage status of data registers

	Upper	Lower	
D100	49	48	(H)
D101	48	47	(H)
D102	21	21	(H)

■Important point

The "Ascii Display" object displays specified texts on one screen as shown above. Accordingly, the screen is not required to be changed over or overlay/be overlaid.

20.12 Creation of comment

Comments (texts) displayed by the comment display function, the alarm list display function and the alarm history display function can be created.

The comment list data is stored in the flush memory built in the GOT.

- Comments can be created in "Draw" in "Comment" in the screen creation software.

Screen of screen creation software

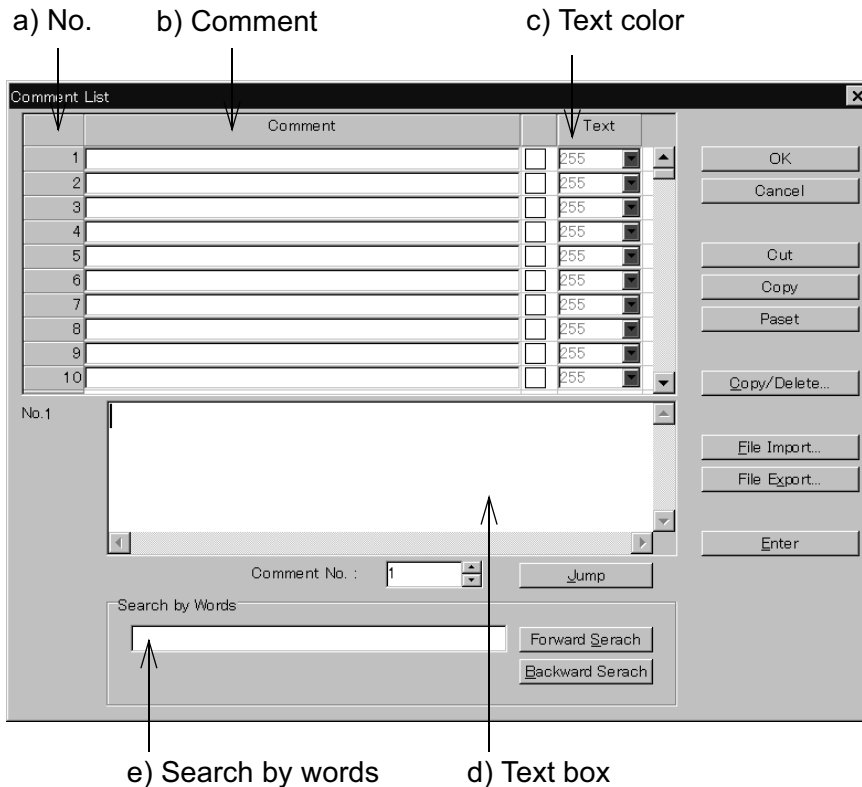

- a) No.
This is an Comment No. used by the comment display function, the alarm list display function and the alarm history display function. Comment No. 0 to No. 32767 can be registered.
- b) Comment
Enter a text to be registered in the comment list.
Up to up to 512 characters (alphabets, numerics and symbols) are available for one comment.
- c) Text color
Enter the text color.
If the text color attribute is changed in the comment display function, the priority is given to that. The color set on this screen is ignored.
- d) Text box
Enter a comment to be registered.
- e) Search by words
When many comments are registered, texts can be searched for.

20.13 Recipe function

GOTs have built-in registers which correspond to 4000 16-bit word devices in the PLC. By setting a bit device ON/OFF in the PLC, data in the GOT can be read from/written to a specified word device in the PLC.

By using the recipe function, initial setting data such as machine processing and positioning data can be transferred to the PLC.

- The recipe function can be set in "Recipe" in "Common" in the screen creation software.

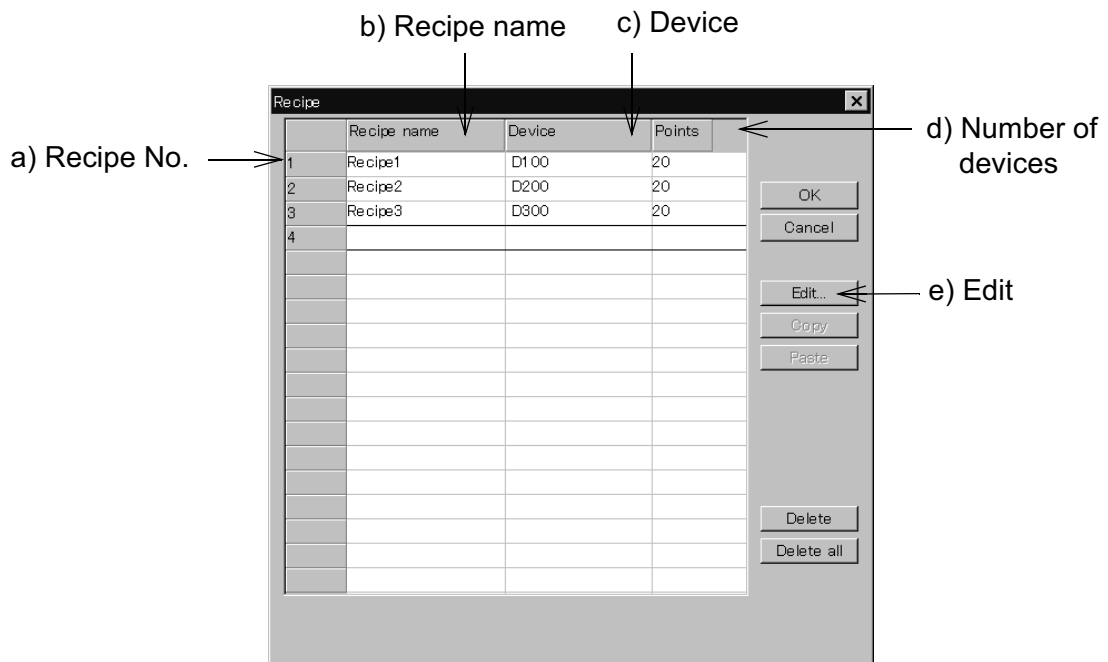

a) Recipe No.

This is a recipe file No. Two or more recipe files can be created as far as the total number of devices is 4000 or less.

By using the system information device for read, the recipe No. to be read or written can be specified from the PLC. (Refer to 6.6.2.)

Write a recipe No. to be read or written subtracted by "1" to the read device.

Examples:

When specifying the recipe No. 1 → Write "0" to the read device.

When specifying the recipe No. 2 → Write "1" to the read device.

b) Recipe name

Enter an arbitrary recipe name.

The recipe name is used to facilitate recognition of each recipe in the screen creation software. The recipe name cannot be displayed on the GOT screen.

c) Device

Enter the head of word devices in the PLC to which the data in the GOT is transferred. Word devices starting from the head word device are occupied as many as d) Number of devices.

Devices can be set using Edit key e).

- d) Number of devices
Enter the number of devices to which data in the GOT is to be transferred.
The number of devices (1 to 4000) set for recipe No. 1 is used for all other recipes starting from recipe No. 2.
- e) Edit key (for detailed setting)
This key allows setting of each recipe file in details.
- 1) Operations
Set b) Recipe Name, c) Device and d) Number of devices.
 - 2) Read trigger
When a specified bit device turns ON or OFF, the contents of word devices starting from the one set in c) Device as many as the number set in d) Number of devices are transferred to the memory built in the GOT.
 - 3) Write trigger
When a specified bit device turns ON or OFF, the data set in "4) Receipt device" are transferred to word devices starting from the one set in c) Device.
 - 4) Recipe device
Enter the value of a device to be written to the PLC.
When data is read using "2) Read trigger", this value is overwritten by the read value.
- The write trigger cannot be omitted. The read trigger can be omitted when read is not required.

■Important point

Transfer from a personal computer

When the complete screen data is read from the personal computer, a data file containing the Recipe, Alarm Conditions, Sampling Conditions, and System Settings is transferred to the GOT along with the screen data.

The data file Read/Write characteristics vary per the GOT version as listed below.

- Changes made to the data file in the GOT cannot be read from the GOT.
 - F930GOT or F933GOT: prior to Version 4.30; F940GOT or F943GOT: prior to Version 6.30; F940WGOT: prior to Version 1.30.
- Changes made to the data file in the GOT can be read from the GOT.
 - F930GOT or F933GOT: Version 4.30 or later; F940GOT or F943GOT: Version 6.30 or later; F940WGOT: Version 1.30 or later. "

20.14 Setting of backlight (F920GOT-K)

In the F920GOT-K, the backlight color can be set to white or red for each screen.

Setting operation

In the GT Designer, select "Screen" in "Auxiliary Setting" in "Common" to display the "Screen Unit Auxiliary Setting" dialog box.

Select a target screen, click the "Edit" button, then select "White" or "Red" for sheet Color in the "Screen Auxiliary Setting" dialog box.

Setting screen

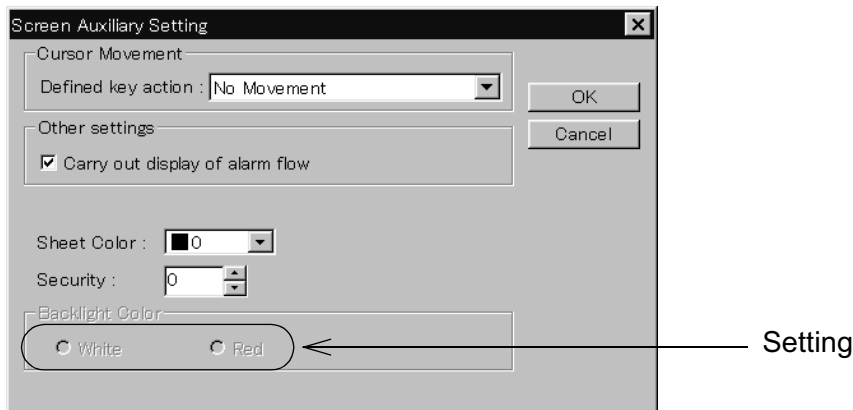

20.15 Assignment of LEDs (F930GOT-K)

In the F930GOT-K, each function key is equipped with a green LED which can be set ON and OFF using an arbitrary device.

Assign a device in "Lamp (External)" in the screen creation software.

Eight devices are occupied from the device No. set in "Lamp (External)". When the set device is ON, the green LED is lit. When the set device is OFF, the LED is extinguished. If no device is set, the LED is always extinguished.

[Setting in the GT Designer]



- The "Lamp (External)" setting is effective for the whole project. (A different setting for individual screen cannot be made.)

21. Changeover of Display Screen (GT Designer)

The previous chapter describes creation of one screen.

Chapter 20 describes how to change over two or more screens.

Screen changeover can be arbitrarily specified using operation keys in the GOT or from the PLC.

21.1 Outline of changeover of display screen

In the GOT, up to 500 screens can be created. A number from 1 to 500 is assigned to each screen.

A screen to be displayed next after the currently displayed screen should be specified using operation keys in the GOT or from the PLC.

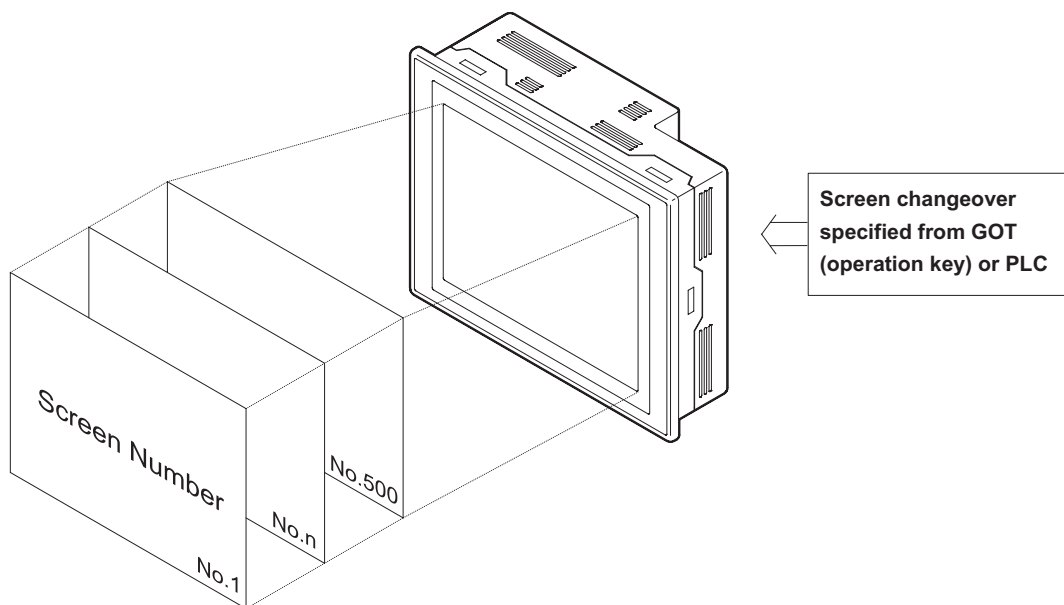

Not only user screens (No. 1 to No. 500) but also system screens (No. 1001 to No. 1030) in the "ALARM MODE" or the "OTHER MODE" can be displayed.

■Important point

1) Creation of user screen No. 1

In the screen mode, screen No. 1 is always displayed immediately after the power is turned ON.

Accordingly, screen No. 1 should be created. If screen No. 1 is not registered, the error message "DISPLAY SCREEN IS NOT AVAILABLE." is displayed.

2) Screen numbers may not be consecutive.

Screen numbers may not be consecutive in such a way as "1, 2, 3 . . ."

When there is a possibility that some screens may be inserted in the future, inconsecutive screen numbers can be used.

However, it is recommended to use consecutive screen numbers because mistakes will be less frequent in screen changeover.

21.2 Changeover of display screen

To changeover the display screen, perform the following setting using the screen creation software.

21.2.1 Contents of setting

- 1) Changeover of the base screen (set in "Switching Screen" in "Common" in the screen creation software)
Specify number of a screen to be displayed using the current value of a word device in the PLC.
Even if the screen is not changed from the PLC, this setting is registered in the screen data and occupies one word device.
- 2) Screen changeover using a touch key (set in "Action" in "Touch Key" in the screen creation software)
The screen is changed when a touch key is pressed.
The number of a screen be displayed can be directly specified (Fixed) or the previous screen displayed (Previous).

21.2.2 Contents of screen changeover operation

Screens are changed over as follows.

- 1) Changeover of the base screen
Common setting can be performed for all screens. This common setting is effective while a user screen (No. 1 to 500) is displayed. As the initial value, the data register D0 is assigned. When the current value of the data register D0 (initial value) or another specified register is overwritten by a sequence program, the display screen is changed over.
- 2) Screen changeover using a touch key or function key
Setting for each user screen (No. 1 to 500) can be performed.
For each screen, up to 50 touch or function key can be registered.

Outline of screen changeover

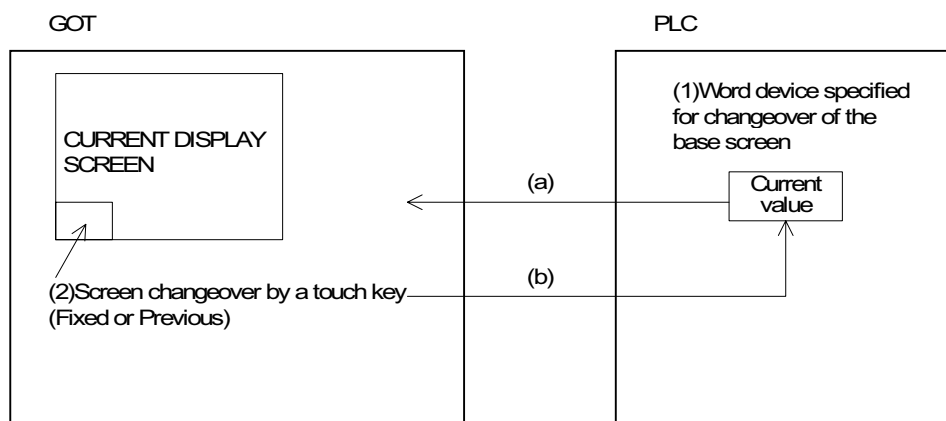

- a) The GOT always monitors the current value of a word device set for "1) Changeover of the base screen", and displays a screen corresponding to the monitored current value.
- b) If "2) Screen changeover using a touch or function key" is set, when a touch or function key is pressed, the GOT automatically writes the Fixed value (directly entered value) or the Previous value (previously displayed screen number) to a word device specified for "1) Changeover of the base screen" and displays a screen corresponding to the written value.

21.3 Changeover of base screen (changeover from PLC)

The number of a screen to be displayed can be specified using the current value of a word device (D, T or C) in the PLC.

The word device can be set in "Switching Screen" in "Common" in the screen creation software. By performing this setting only once, a screen to be displayed next can be specified from the PLC for any screen as the setting is effective to all screens.

21.3.1 Outline of changeover of base screen

- Base screen changeover settings can be performed using the screen creation software.

Setting for screen changeover

Base screen : Specify the screen number to be displayed by the word device, D, C and T. (initial value = D0)

Overlap window 1: Screen overlaying the base screen (initial value = none)

Overlap window 2: Screen overlaying the overlap window 1 (For screen overlay, refer to Section 6.5.)

Example: When the word device D0 is used to change over the base screen

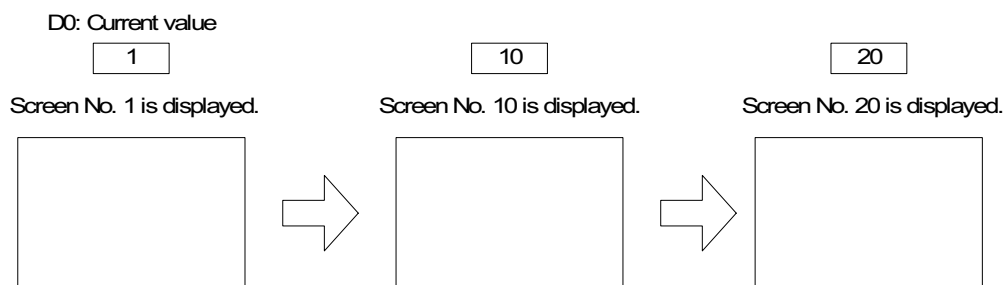

- When the display screen is changed over using a touch key as described in the next section, a screen number specified by the touch key is stored as the current value of the word device specified for "changeover of the base screen". However, when a system screen (No. 1001 to No. 1030) is displayed using a touch key, the screen number is not stored. For changeover to a system screen, refer to Section 20.5.

■Important point

Initialization of a word device used to specify the base screen

If the current value of a word device used to specify the base screen is "0", the error message "DISPLAY SCREEN IS NOT AVAILABLE." is displayed in the screen mode because the user screens start from the screen No. 1. In the screen changeover setting in the GT Designer, it is recommended to initialize a word device used to specify the base screen when the power of the GOT is turned ON unless otherwise required.

This setting can be performed also on the system screen of the GOT. (Refer to 5.2.13.)

21.3.2 Example of base screen changeover

- An example of base screen changeover is shown below.
Setting for changeover of the base screen (in "Switching Screen" in "Common" in the screen creation software)

Base screen : D0 (initial value)

Overlap window 1: Not set (Screen overlay will not be performed.)

Overlap window 2: Not set (Screen overlay will not be performed.)

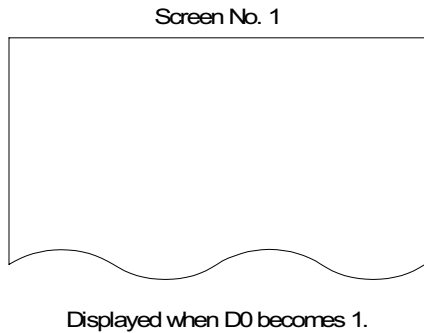

- Immediately after the GOT has been put into screen mode, screen No. 1 is always displayed. (If screen No. 1 has not been created, the error message "DISPLAY SCREEN IS NOT AVAILABLE." is displayed.)

- Program in

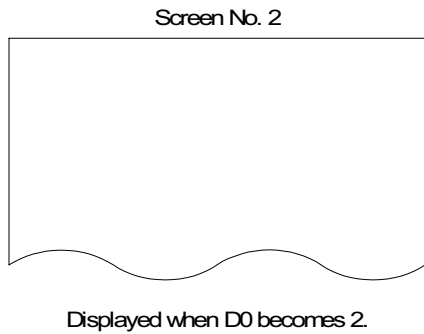
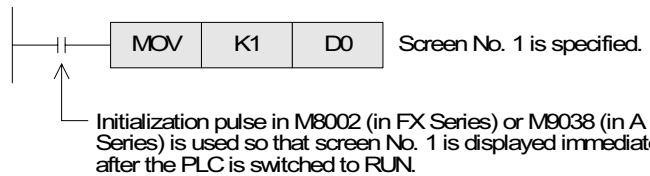

- When the sequence program shown below is executed, the screen is changed over to the specified screen.

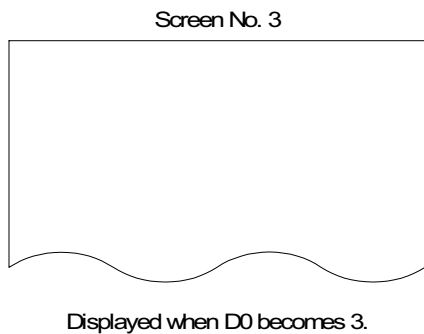
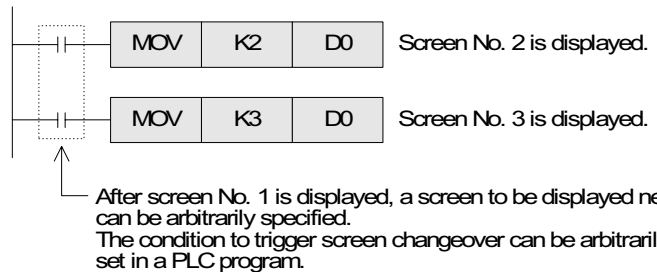

- In this example, word device D0 used to specify the base screen, is not located in the battery backup area. Accordingly, if screen mode is selected in the GOT while the PLC is stopped, the error message "DISPLAY SCREEN IS NOT AVAILABLE." is displayed. If the error message is to be avoided, use a word device in the battery backup area.

21.4 Screen changeover by touch key or function key

To change over the display screen using a touch key provided on the screen, two methods are available. In fixed value method, the number of a screen to be displayed next can be directly entered. In Previous method, the previously displayed screen is displayed next.

Touch key — Fixed :Allows to enter the number of a screen to be displayed next.
 — Previous :Returns to the previous screen.

- Only one method (Fixed or Previous) can be assigned to one touch key or one function key. (A function other than the screen changeover such as the bit ON/OFF function can be assigned to a touch key or function key to which either the fixed value method or the upper hierarchy method has been assigned.)
- Touch keys or function keys are be set for each screen.

21.4.1 Changeover using a fixed value

When a touch key or function key is pressed, the set screen is displayed.

Touch key (Fixed): Enter one among the following screen numbers.

Screen No. 1 to No. 500 (user screen)

Screen No. 1001 to No. 1030 (system screen): Refer to the appendix.

Example of screen changeover (using touch keys)

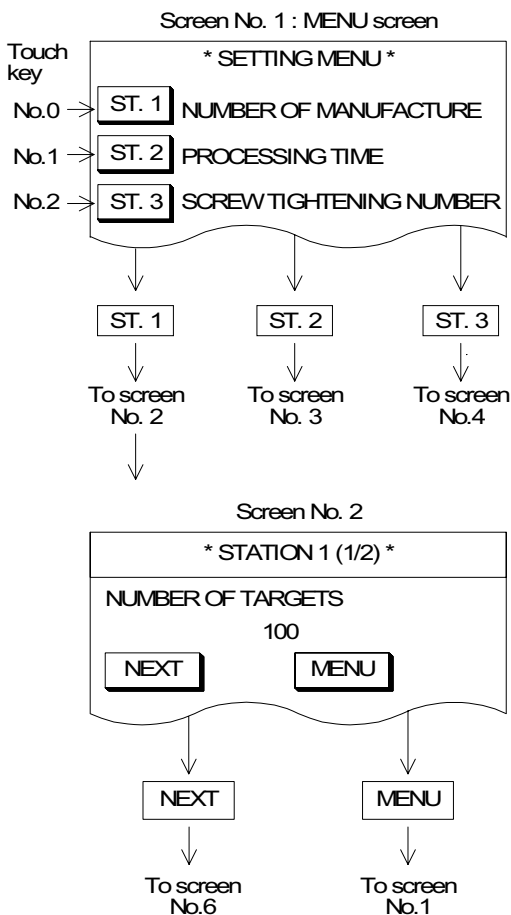

- When the screen No. 1 is created and either "ST. 1", "ST. 2" or "ST. 3" is pressed, the corresponding screen is displayed.

"ST. 1" key : Fixed value = 2

"ST. 2" key : Fixed value = 3

"ST. 3" key : Fixed value = 4

* Characters "ST. 1" to "ST. 3" are set as touch keys or "Text" objects.

- When "ST. 1" key is pressed, screen No. 2 is displayed as assigned in the touch key setting.

"NEXT" key : Fixed value = 6

"MENU" key: Fixed value = 1

When the "MENU" key is pressed, screen No. 1 is displayed as assigned. Or screen No. 1 is displayed in accordance with the Previous specification described in the next section.

21.4.2 Changeover to Previous screens

By pressing a touch or function key, the previously displayed screen is shown. This function is useful to return to the previous screen in such a case that an abnormality had occurred in the machine and an error message was displayed.

Previous: Enter one among the following screen numbers.

Screen No. 1 to No. 500 (user screen)

Screen No. 1001 to No. 1030 (system screen): Refer to the appendix.

Contents stored in the screen number storage memory

The GOT has one screen number storage memory which stores the previous screen without regard to the setting at that time.

Displayed screen and memory to store screen number

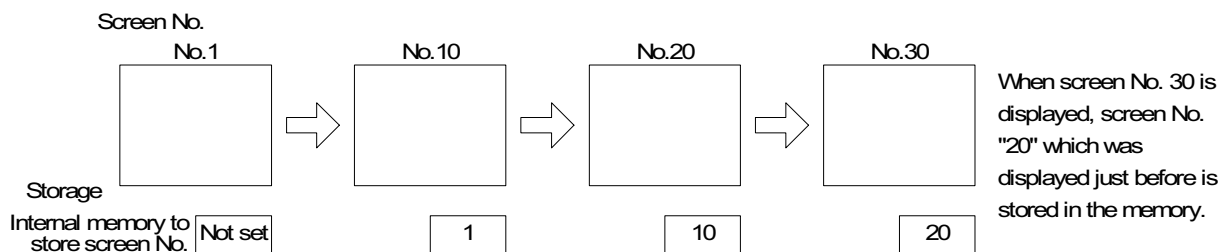

- The internal memory keeps the screen number while the GOT is on, and it clears the number when the GOT is turned off.

Keeping of the contents stored in the screen number storage memory

The contents stored in the screen number storage memory is kept only while the power is turned on in the GOT main body. When the power is turned off, the memory is cleared.

Example of screen changeover to Previous (using touch keys)

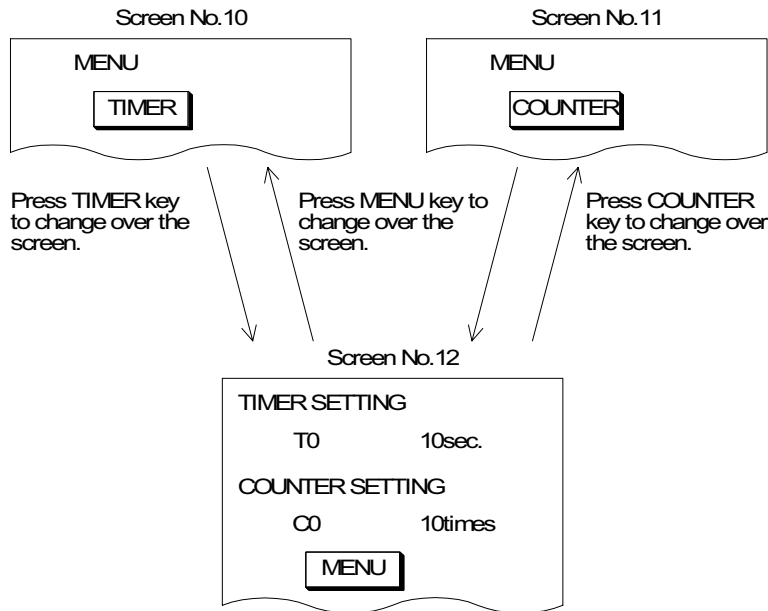

- Screen No. 10 is set so that it will be changed over to screen No. 12 in accordance with the fixed value assigned to the touch keys.
"TIMER" key: Fixed value = 12
- Screen No. 11 is set so that it will be changed over to screen No. 12 by the Fixed value assigned to the touch keys.
"COUNTER" key: Fixed value = 12
- Screen No. 11 is set so that it will be returned to the previous screen (screen No. 10 or No.11) by Previous setting assigned to the touch key.
"MENU" key: Previous

21.5 Changeover to system screen

Function screens built in the GOT such as HPP MODE, SAMPLING MODE, ALARM MODE and OTHER MODE can be displayed as user screens.

21.5.1 Display example of system screen

This section describes the method to display a system screen as a user screen (USER SCREEN MODE) and the caution on this method.

- A system screen can be displayed by specifying a corresponding screen number shown in the next page (Refer to 22.5). Prior to this, the following settings should be set so that the previous user screen can be displayed after the system screen.

1) When a system screen is displayed as the base screen (from the PLC)

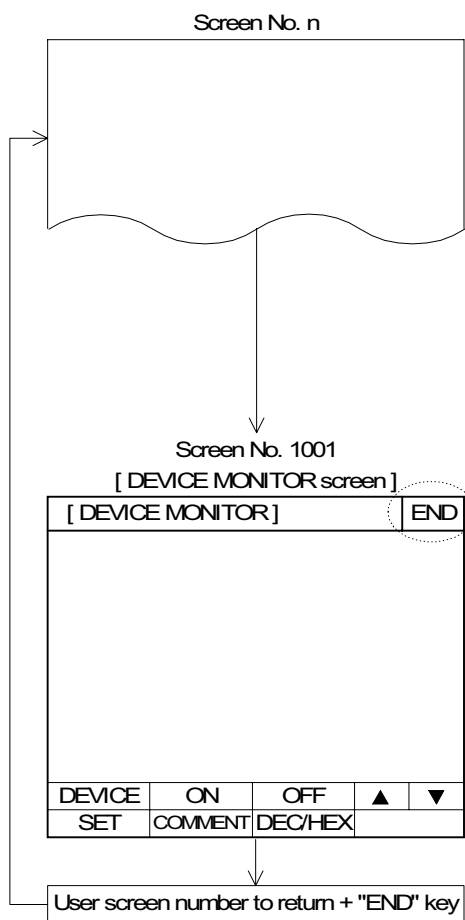

- When the sequence program shown below is executed while screen No. n is displayed, screen No. 1001 (DEVICE MONITOR screen) is displayed.

- Word device to change over the base screen of the GOT: D0

- Program in PLC

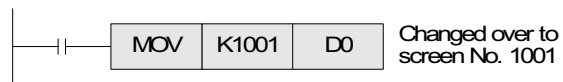

- To return to the previously displayed user screen from a system screen, execute a program which specifies the screen to be returned and press the END key provided at the upper right corner of the system screen. Then, the previous user screen is displayed again.

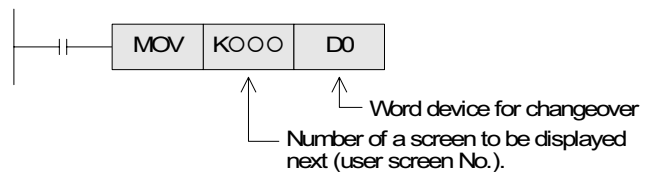

- A sequence program to return to a user screen can be executed at any time while a system screen is displayed.

2) When a system screen is displayed using a touch or function key

- Specify a desired screen number within the range of No. 1001 to No. 1030 in the same way as specification of a user screen.
- When the END key (ESC key in the F920GOT-K) provided at the upper right corner of the system screen is pressed, the previous user screen is automatically displayed again. (That is, the setting to return to the previous screen is not required.)

21.6 Application of screen changeover

This section describes application examples of screen changeover.

21.6.1 Application example 1

In the example below, an abnormality occurs with the machine in operation mode, an error message is displayed, then a previous screen is displayed.

Changeover of the base screen

Word device specifying the changeover destination: D0 (initial value)

.....Registered as the common setting for all screens.

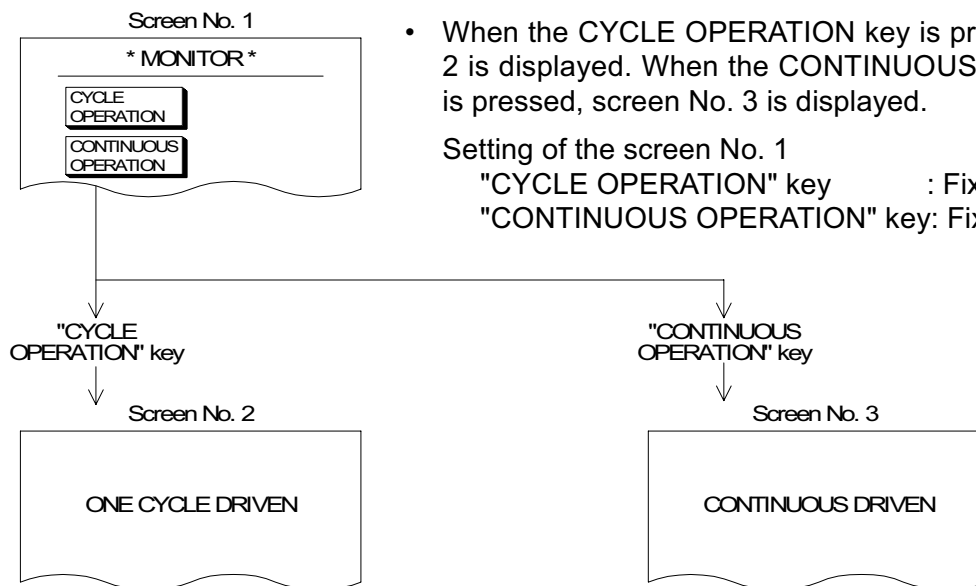

- When the CYCLE OPERATION key is pressed, screen No. 2 is displayed. When the CONTINUOUS OPERATION key is pressed, screen No. 3 is displayed.

Setting of the screen No. 1

"CYCLE OPERATION" key : Fixed value = 2

"CONTINUOUS OPERATION" key: Fixed value = 3

- When the program shown in the following page is executed while screen No. 2 or 3 is displayed, screen No. 10 is displayed by the base screen changeover function.

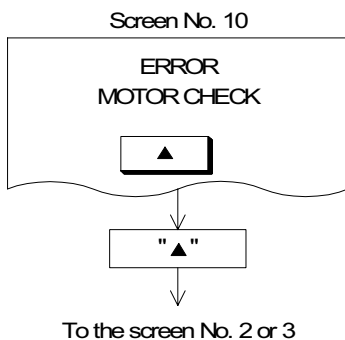

- To return to the previous screen (screen No. 2 or 3) from screen No. 10, use the Previous function of a touch key.

Setting of screen No. 10

PREVIOUS key: Previous

- When the previous screen is to be displayed, as shown in this example, use the Previous function on a touch key.

- Program example for application example 1

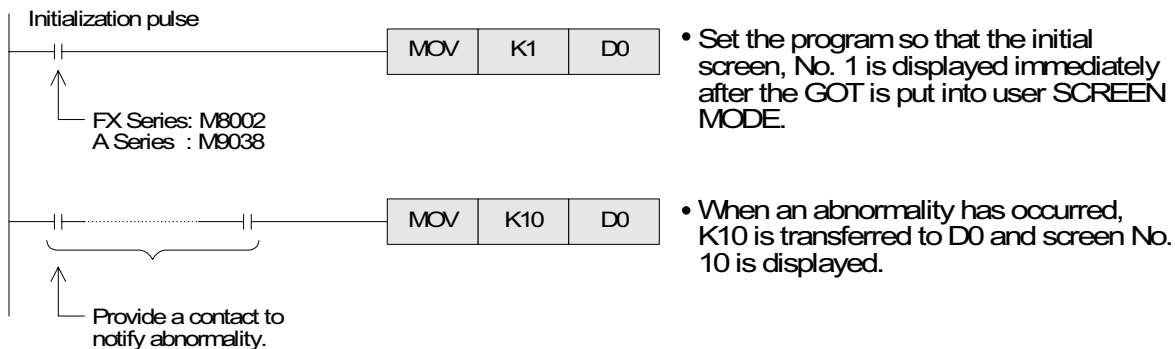

21.6.2 Application example 2

In the example below, changeover of the base screen and screen changeover using touch keys is combined.

Changeover of the base screen

Word device specifying the changeover destination: D0 (initial value)

.....Registered as the common setting for all screens

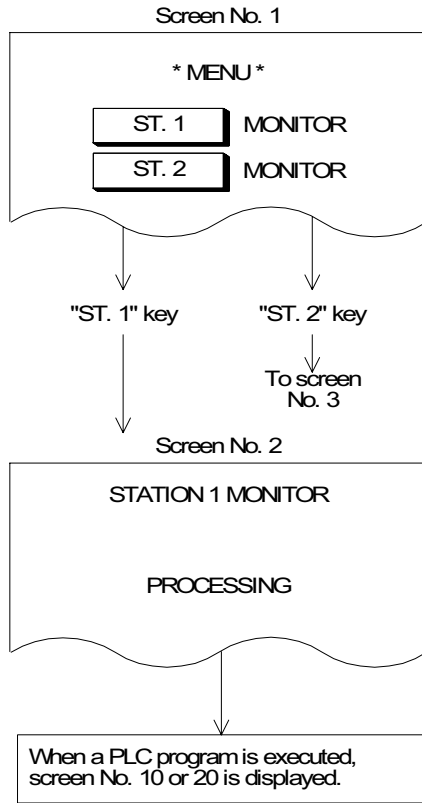

- When ST. 1 is pressed, screen No. 2 is displayed. When ST. 2 is pressed, screen No. 3 is displayed.

Setting of screen No. 1

ST. 1 key : Fixed value = 2

ST. 2 key : Fixed value = 3

- When the sequence program shown below is executed while screen No. 2 is displayed, screen No. 10 or 20 is displayed by the base screen changeover function.

- Program example for application example 2

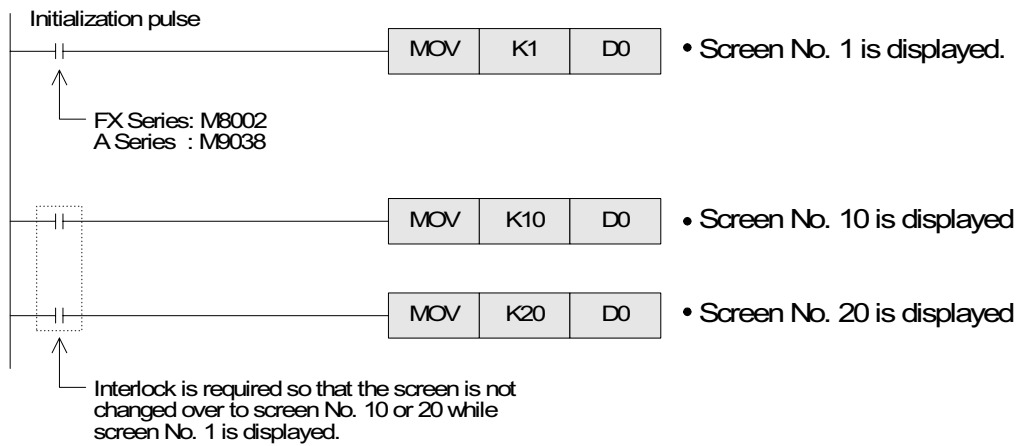

MEMO

22. Appendix

22.1 Number of registered screen construction elements

Number of registered screen construction elements (Common to F920GOT-K, F930GOT-K, F930GOT, F933GOT, F940GOT, F943GOT and F940WGOT)

Screen construction element name		Number of registered objects			
		[A]	[B]	[B']	[C]
GT Designer	FX-PCS-DU/ WIN-E	Per screen	Common set screen	Screen call	Viewable for screen display
Ascii display	Ascii	10	10	10	10
Ascii input					
Numerical display	Number				
Numerical input					
Comment display (word specification)	Library Text	50	50	50	50
Bar graph	Bar graph				
Part Display (word specification)	Library Image				
—	Circle graph				
Panel meter	Panel meter				
Statistics graph	Proportional bar graph	10	10	10	10
	Proportional Pie graph				
Trend graph	Trend Graph	1	1	1	1
Line graph	Line Graph	1	1	1	1
Comment display (bit specification)	Text Indicator				
Lamp	Indicator	50	50	50	50
	Overlay Screen				
	Label Indication				
Part Display (bit specification)	Image Indication				
—	Buzzer				
Clock display	Date	10	10	10	10
	Time				

Screen construction element name		Number of registered objects			
		[A]	[B]	[B']	[C]
GT Designer	FX-PCS-DU/ WIN-E	Per screen	Common set screen	Screen call	Viewable for screen display
Touch key *1	Switch	50	50	50	50
	Send Databank				
	Increment				
	Decrement				
	Data Setting	50	50	50	50
	Change Screen				
	Write constant				
	Touch key				
Panel kit	Keyboard	1	1	1	1
Alarm history display	Alarm History display	1	1	1	1
Alarm list display (user alarm)	Alarm List (user alarm)	1	1	1	1
Floating Alarm display	Moving Alarm display	1	1	1	1

The maximum objects viewable for one screen display is shown in [C]. The configuration is as follows: $[A] + [B] + [B'] \leq [C]$

When overlay is performed using the screen overlay function or lamp (screen) function, the number of viewable objects is also as shown in [C].

*1 When using the F920GOT-K, a function key is regarded as an 'external key' and each function is allocated to it.

Number of objects registered in library

Library name	Number
Text library	2000
Image library	2000

Data capacity

Item	Description
Full-screen data size	128 kbyte (user screen, external characters, etc.) ... F920GOT-K
	256 kbyte (user screen, external characters, etc.) ... F930GOT, F933GOT, F930GOT-K
	512 kbyte (user screen, external characters, etc.) ... F940GOT, F943GOT
	1 Mbyte (user screen, external characters, etc.) ... F940WGOT

22.2 Comparison with screen creation software

Display function

Name in GT Designer	Difference in set item (attribute)	Name in FX-PCS-DU/WIN-E
Numerical Display	←When setting is forbidden	Number
Numerical Input	←When setting is permitted	
Ascii Display	←When setting is forbidden	Ascii
Ascii Input	←When setting is permitted	
Comment	In case of word device→	Library Text
	In case of bit device→	Text Indicator
Part Display	In case of word device→	Library Image
	In case of bit device→	Image Indicator
Lamp	Name is different.	Label Indicator
Panelmeter	Shape displayed on screen is different.	Panel Meter Circle Graph
Clock	Name is different.	Date
	Name is different.	Time
Trend graph	Sampling is available in background processing.	Trend Graph
Line graph	Name is different.	Line Graph
Statistics	In case of bar graph→	Proportional Bar Graph
	In case of circle graph→	Proportional Pie Graph
Bar	Reference value is equivalent to upper or lower limit value. Only one data can be set at a time.→	Bar Graph
Line (Draw Figure)	Same→	Line
Rectangle	Name is different.	Box
Circle	Ellipse is not available.→	Circle
Bitmap	←Saved in objects file.	Image
Text	Name is different.	Text

- In the case of FX-PCS-DU/WIN-E, "Transparent/Non-transparent" can be set in displaying numeric values, characters and some figures. In the case of GT Designer, the background color is fixed to "Transparent".

Key functions

Name in GT Designer	Difference in set item (attribute)	Name in FX-PCS-DU/WIN-E
Bit operation (Bit momentary)	Names are different.	Switch (momentary)
(Bit ALT)		Switch (alternate)
(Bit SET)		Switch (set)
(Bit RST)		Switch (reset)
Base changeover	←Bit condition, etc. cannot be converted.	Change Screen

Name in GT Designer	Difference in set item (attribute)	Name in FX-PCS-DU/WIN-E
Word operation (Indirect + Fixed value)	Names are different.	Increment
(Indirect + Fixed value)		Decrement
(Fixed value)		Write Constant

Others

Name or item in GT Designer	Difference in set item (attribute)	Name or item in FX-PCS-DU/WIN-E
F940WGOT applicable	← Divided display is available in GT Designer. (ALARM MODE is not provided on F930WGOT system screen)	F940WGOT applicable
Multi-CPU system applicable	← Only GT Designer can set.	—
—	Only FX-PCS-DU/WIN-E can set.→	Connection to N series manufactured by FUJI ELECTRIC CO., LTD.
—	Only FX-PCS-DU/WIN-E can set.→	Element comment
—	Only FX-PCS-DU/WIN-E can set.→	External character registration
—	Only FX-PCS-DU/WIN-E can set.→	Buzzer
—	Only FX-PCS-DU/WIN-E can set.→	Data change
Recipe	In the case of FX-PCS-DU/WIN-E, transferring can be made with a touch key.→	Data file transfer
Base changeover	In the case of FX-PCS-DU/WIN-E, screen changeover can be made with a touch key only (not via devices in the PLC).→	Screen changeover
Parts	Only bit map is converted.→ ← Only construction elements displayed on the screen can be registered. Display position adjusting, parts color changing, saving in files and printing can be performed.	Image library
Comment	Names are different	Text library
System information	← Roles of devices are different.	Control element
Password	Names are different	ID number

22.3 Differences in functions among display units and connected PLC

✓ : Available function

✕ : Unavailable function

Mode	Function	Display unit type			
		F920GOT-K	F930GOT F933GOT F930GOT-K	F940GOT F943GOT	F940WGOT
SCREEN MODE	Character display	✓	✓	✓	✓
	Drawing	✓	✓	✓	✓
	Data display	✓	✓	✓	✓
	Data change	✓ *1	✓ *1	✓	✓
	Switch function	✓ *1	✓ *1	✓	✓
	Screen changeover	✓ *1	✓ *1	✓	✓
	Data batch transfer	✓ *1	✓ *1	✓	✓
	Security function (screen protection function)	✓	✓	✓	✓
HPP MODE	Reading/writing/monitoring of programs	✕	✕	✓	✓
	Reading/writing of parameters	✕	✕	✓	✓
	Monitoring of buffer memories (BFM) in special blocks and changing of their set values	✕	✕	✓	✓
	Device monitor	✓	✓	✓	✓
	Changing of current values/set values of word device	✓	✓	✓	✓
	Forced ON/OFF of bit devices	✓	✓	✓	✓
	State monitor in ON status	✕	✓	✓	✓
	PLC diagnosis (Error information in the PLC can read and displayed.)	✕	✓	✓	✓
SAMPLING MODE	Condition setting	✕	✕	✓	✓
	Result display (list, graph)	✕	✕	✓	✓
	Data clear	✕	✕	✓	✓
ALARM MODE	List display	✓ *2	✓ *2	✓	✓
	Alarm history display (The alarm history is saved together with the occurrence time in order of occurrence.)	✓ *2	✓ *2	✓	✓
	Frequency (The number of occurrences of each alarm is stored.)	✕	✕	✓	✓
	Alarm history clear	✓ *2	✓ *2	✓	✓
TEST MODE	Screen list	✓	✓	✓	✓
	Data file	✕	✕	✓	✓
	Debug operation	✕	✕	✓	✓
	Communication monitor	✕	✕	✓	✓

Mode	Function	Display unit type			
		F920GOT-K	F930GOT F933GOT F930GOT-K	F940GOT F943GOT	F940WGOT
OTHER MODE	Time switch	✓ ^{*3}	✓	✓	✓
	PC transfer	✓	✓	✓	✓
	Printer output	✕	✓	✓	✓
	Entry code	✓ ^{*6}	✓	✓	✓
	System settings ^{*4}	✓	✓	✓	✓
2-port interface function ^{*5}		✓	✓	✓	✓

✓ : Available function

✗ : Unavailable function

Mode	Function	Connected PLC				
		FX	A	QnA	Q	PLC manufactured by other companies
SCREEN MODE	Character display	✓	✓	✓	✓	✓
	Drawing	✓	✓	✓	✓	✓
	Data display	✓	✓	✓	✓	✓
	Data change	✓	✓	✓	✓	✓
	Switch function	✓	✓	✓	✓	✓
	Screen changeover	✓	✓	✓	✓	✓
	Data batch transfer	✓	✓	✓	✓	✓
	Security function (screen protection function)	✓	✓	✓	✓	✓
HPP MODE	Reading/writing/monitoring of programs	✓	✗	✗	✗	✗
	Reading/writing of parameters	✓	✗	✗	✗	✗
	Monitoring of buffer memories (BFM) in special blocks and changing of their set values	✓	✗	✗	✗	✗
	Device monitor	✓	✓	✓	✓	✓
	Changing of current values/set values of word device	✓	✓	✓	✓	✓
	Forced ON/OFF of bit devices	✓	✓	✓	✓	✓
	State monitor in ON status	✓	✗	✗	✗	✗
	PLC diagnosis (Error information in the PLC can read and displayed.)	✓	✗	✗	✗	✗
SAMPLING MODE	Condition setting	✓	✓	✓	✓	✓
	Result display (list, graph)	✓	✓	✓	✓	✓
	Data clear	✓	✓	✓	✓	✓
ALARM MODE	List display	✓	✓	✓	✓	✓
	Alarm history display (The alarm history is saved together with the occurrence time in order of occurrence.)	✓	✓	✓	✓	✓
	Frequency (The number of occurrences of each alarm is stored.)	✓	✓	✓	✓	✓
	Alarm history clear	✓	✓	✓	✓	✓
TEST MODE	Screen list	✓	✓	✓	✓	✓
	Data file	✓	✓	✓	✓	✓
	Debug operation	✓	✓	✓	✓	✓
	Communication monitor	✓	✓	✓	✓	✓

Mode	Function	Connected PLC				
		FX	A	QnA	Q	PLC manufactured by other companies
OTHER MODE	Time switch	✓	✓	✓	✓	✓
	PC transfer	✓	✓	✓	✓	✓
	Printer output	✓	✓	✓	✓	✓
	Entry code	✓	✓	✗	✗	✗
	System settings *2	✓	✓	✓	✓	✓
2-port interface function *3		✓	✓	✓	✓	✗

- *1 When using the F920GOT-K, allocate each function to a function key.
When using the F930GOT-K, these functions can be allocated to either touch keys or function keys.
- *2 In the F920GOT-K, F930GOT-K, F930GOT, and F933GOT, ALARM MODE is not available on system screens, but the similar display is available in USER SCREEN MODE. The date and time is not displayed in the F920GOT-K.
- *3 In the F920GOT-K, clock data of the PLC is displayed.
This function can be used only when connected to the PLC equipped with a clock function or either a memory cassette or memory board.
- *4 In the case of F940WGOT, brightness adjustment replaces LCD contrast in system settings.
In the case of F920GOT-K, F930GOT-K, F930GOT, F933GOT and F940WGOT, Handy GOT settings and auxiliary settings are not available.
- *5 The 2-port interface function (including connection of two or more units) is available only when the following connections are made.
PLC ladder edit via 2-port interface function is available only when the F920GOT-K is connected to the FX Series PLC. (Connection of two or more GOT units cannot be performed without regard to the connected PLC.)
- FX Series : When directly connected to a CPU
- A Series : When directly connected to a CPU (Not available when connected to computer link unit)
- QnA Series : When directly connected to a CPU or a serial communication unit is used (When a serial communication unit is used, the connection type is CPU connection.)
- Q Series : When directly connected to a CPU or a serial communication unit is used (When a serial communication unit is used, the connection type is CPU connection.)
- General-purpose communication: When directly connected to a CPU
(Only the connection of two or more units can be done.)
- One among the above PLCs should be connected with the GOT on the 1:1 basis.
 - The personal computer should be connected to the RS-232C port of the GOT.
- *6 Only the UNLOCK function is available.

22.4 Key pad operation on system screens (F930GOT-K)

In the F930GOT-K, manipulate the system screens using the touch keys on the display unit. The key pad is available also on the following system screens.

✓: Available ✕: Not available

Mode	Screen	Ten-keys	Cursor	SET	DEV	ENT	ESC
HPP	DEVICE MONITOR	✓	✓	✓	✓	✓	✓
OTHER	SET TIME SWITCH	✓	✓ ^{*1}	✕	✕	✓	✓
	ENTRY CODE	✓	✕	✕	✕	✓	✓
	taitoru gamen?	✓	✕	✕	✕	✓	✓
	genzai jikoku?	✓	✕	✕	✕	✓	✓
	bakku raito?	✓	✕	✕	✕	✓	✓

*1 Available only for movement between "Number" objects which can be input.

- While any other system screen not shown above is displayed, use the touch keys on the display unit.

22.5 System Screen Number

A system screen can be displayed when a corresponding screen No. shown below is specified.

Screen number	Mode name	Function name (screen name)	Reference section
1001	HPP MODE	DEVICE MONITOR screen	8.4
1002		ACTIVE STATE MONITOR screen	8.6
1003		PC DIAGNOSIS screen	8.8
1004	SAMPLING MODE	SET CONDITION screen	9.2
1005		DISPLAY LIST screen	9.3.1
1006		DISPLAY GRAPH screen	9.3.2
1007		CLEAR DATA screen	9.4
1008	ALARM MODE	DISPLAY STATUS screen	10.3.2
1009		DISPLAY HISTORY screen	10.3.3
1010		DISPLAY FREQUENCY screen	10.3.4
1011		CLEAR HISTORY screen	10.3.5
1012	TEST MODE	DATA BANK screen	11.3
1013	OTHER MODE	SET CLOCK (SET-UP MODE) screen	5.2.7
1014		SET TIME SWITCH screen	12.2
1015		SET BACKLIGHT (SET-UP MODE) screen	5.2.8
1016		ENTRY CODE screen	12.5
1017		PRINT OUT (SAMPLING DATA) screen	12.4
1018		PRINT OUT (ALARM HISTORY) screen	12.4
1019		BUZZER (SET-UP MODE) screen	5.2.9
1020		SERIAL PORT (SET-UP MODE) screen	5.2.4
1021		LCD CONTRAST (SET-UP MODE) screen	5.2.10
1022	HPP MODE	PROGRAM LIST screen	8.2
1023		PARAMETER screen	8.3
1024		LIST MONITOR screen	8.5
1025		BFM MONITOR screen	8.7
1026	TEST MODE	USER SCREEN screen	11.2
1027	OTHER MODE	LANGUAGE (SET-UP MODE) screen	5.2.2
1028		PLC TYPE (SET-UP MODE) screen	5.2.3
1029		OPENING SCREEN (SET-UP MODE) screen	5.2.5
1030		MAIN MENU CALL KEY (SET-UP MODE) screen	5.2.6

22.6 Key Code List

1) Key code list for numerics and ASCII codes

Key	Key code (H)	Key	Key code (H)	Key	Key code (H)	Key	Key code (H)
SP	0020	@	0040	'	0060	(Clear)	0088
!	0021	A	0041	a	0061		
"	0022	B	0042	b	0062		
#	0023	C	0043	c	0063		
\$	0024	D	0044	d	0064		
%	0025	E	0045	e	0065		
&	0026	F	0046	f	0066		
'	0027	G	0047	g	0067		
(0028	H	0048	h	0068		
)	0029	I	0049	i	0069		
*	002A	J	004A	j	006A		
+	002B	K	004B	k	006B		
,	002C	L	004C	l	006C		
-	002D	M	004D	m	006D		
.	002E	N	004E	n	006E		
/	002F	O	004F	o	006F		
0	0030	P	0050	p	0070		
1	0031	Q	0051	q	0071		
2	0032	R	0052	r	0072		
3	0033	S	0053	s	0073		
4	0034	T	0054	t	0074		
5	0035	U	0055	u	0075		
6	0036	V	0056	v	0076		
7	0037	W	0057	w	0077		
8	0038	X	0058	x	0078		
9	0039	Y	0059	y	0079		
:	003A	Z	005A	z	007A		
;	003B	[005B	{	007B		
<	003C		005C		007C		
=	003D]	005D	}	007D		
>	003E	^	005E	~	007E		
?	003F	_	005F		007F		

22.7 Device Name Which Can Be Monitored

This section explains the device range of the PLC available in the GOT-900. The device range shown here is the maximum value which can be set in the screen creation software.

The device specifications vary depending on the model of the PLC even if the series name is equivalent. When looking at the table, change the device range shown in the table with the device range available in the actually connected PLC. (Example: In the FX Series, the FX1N PLC has fewer devices than in the FX2N PLC.)

Also, the available device range and device names vary depending on the screen creation software.

22.7.1 Devices in GOT-F900

The table below shows intrinsic devices built in the GOT-F900.

Because these internal devices are not related to the devices of the connected PLC or the memory of a microcomputer board, they are available without regard to the connected equipment.

These internal devices in the GOT-F900 can be rewritten by the status monitoring function, the switch function and the numeric value input function, and used for lamp indicator, numeric value display, switch condition, etc.

Device name		Available range	Device number representation
Bit device	GB (GOT internal device)	132 to 1023	Decimal
Word device	GD (GOT internal device)	100 to 1023	Decimal

Applicable screen creation software

The GT Designer is available from the first version. The DU/WIN is available from Version 2.50 and later.

Allocation of devices used for internal processing

Device name		Available range		Device number representation
Bit device	GB (GOT internal device)	GB0 to GB131	Unavailable	Decimal
		GB132 to GB255	Available (only in the F920GOT-K)	
		GB256 to GB1023	Available (excluding the F920GOT-K)	
Word device	GD (GOT internal device)	GB0 to GB99	Unavailable	Decimal
		GB100 to GB127	Available (only in the F920GOT-K)	
		GB128 to GB1023	Available (excluding the F920GOT-K)	

- GB 0 to GB 131 and GD 0 to GD 99 are the internal devices used for the processing inside the GOT-F900. However, the devices with the following functions can be used by the user.

Device	Function
GD0	Current time (second)
GD1	Current time (minute)
GD2	Current time (hour)
GD3	Current time (day)
GD4	Current time (month)
GD5	Current time (year)
GD6	Current time (day of week)
GD7	Not to be used
GD8,GD9	Upper limit of input numerical value (32 bit)
GD10,GD11	Lower limit of input numerical value (32 bit)
GD12	Numerical value, Ascii input
GD13 to GD99	Not to be used
GD100 to GD1023	For user's use

Device	Function
GB0 to GB12	Not to be used
GB13	Communication error
GB14,GB15	Not to be used
GB16	Buzzer (Issued once) *1
GB17	Buzzer (Issued three times) *1
GB18	Buzzer (Issued continuously) *1
GB19 to 131	Not to be used
GB132 to GB1023	For user's use

*1 Buzzer is available in the following OS.

F940WGOT	Ver. 1.40 or later
F940GOT	Ver. 6.40 or later
F930GOT	Ver. 4.40 or later
F930GOT-K	Ver. 4.50 or later
F920GOT-K	Ver. 1.00 or later
Handy GOT	Ver. 6.40 or later

22.7.2 PLC by Mitsubishi

1) MELSEC-F FX Series

Device name		Setting range		Device number representation		
		GT Designer	DU/WIN			
Bit device	Input relay (X)		X000~X377	X000~X377	Octal	
	Output relay (Y)		Y000~Y377	X000~X377		
	Auxiliary relay (M)		M0000~M3071	M0000~M3071		
	Special auxiliary relay (M)		M8000~M8255	M8000~M8255	Decimal	
	State (S)		S0~S999	S0~S999		
	Timer contact (T)		T0~T255	T0~T255		
	Counter contact (C)		C000~C255	C0~C255		
	GOT internal bit register (GB) ^{*2}		GB132~GB1023	GB132~GB1023		
Word device	Timer (T)	Present value	T0~T255	T0~T255	Decimal	
		Set value	TS0~TS255	-		
	Counter (C)	16 bits	Present value	C0~C199		C0~C199
			Set value	CS0~CS199		
		32 bits	Present value	C200~C255		C200~C255
			Set value	CS200~CS255		
	Data register (D)		D0~D999	D0~D999		
	File register (D)		D1000~D7999	D1000~D7999		
	Special data register (D)		D8000~D8255	D8000~D8255		
	Index register		-	Z		
-			V			
GOT internal data register (GD) ^{*2}		GD100~GD1023	GD100~GD1023			

- In specifying word devices of a bar code reader, C200 to C255 are not available.

*1 In data change, the following operation is executed.

1. When an EPROM memory cassette is attached to the PLC, data cannot be changed.
2. When an entry code is registered in the PLC, data cannot be changed.
3. When an EEPROM memory cassette or EEPROM memory board is attached to the PLC, the following operation is executed.
 - When the write-protect switch is ON, data cannot be changed.
 - When the write-protect switch is OFF, data can be changed only while the PLC is in the stop status.

*2 GB132 to GB255 and GD100 to GD127 can be used in the F920GOT-K.

2) MELSEC-A/Q (A mode) Series (including motion controller)

Device name		Setting range		Device number representation	
		GT Designer	DU/WIN		
Bit device	Input (X)		X0~X0FFF	Hexadecimal	
	Output (Y)		Y0~Y0FFF		
	Internal relay (M) *1		M0~M8191	Decimal	
	Latch relay (L) *1		L0~L8191		
	Annunciator (F)		F0~F2047		
	Link relay (B)		B0~B1FFF	Hexadecimal	
	Special internal relay (M)		M9000~M9255	Decimal	
	Timer (T)	Contact	TT0~TT2047		T0~T2047
		Coil	TC0~TC2047		–
	Counter (C)	Contact	CT0~CT1023		C0~C1023
		Coil	CC0~CC1023		–
	GOT internal bit register (GB)*3		GB132~1023		GB132~1023
Word device	Data register (D)		D0~D8191	Hexadecimal	
	Special data register (D)		D9000~D9255		
	Link register (W)		W0~W1FFF		
	Timer (T)	Present value	TN0~TN2047	T0~T2047	Decimal
		Set value	TS0~TS2047	T0~T2047	
	Counter (C)	Present value	CN0~CN1023	C0~C1023	
		Set value	CS0~CS1023	C0~C1023	
	File register (R)		R0~R8191	R0~R8191	
	Index register (Z, V) *2		Z0~Z6(Z0=Z)	Z	
			V0~V6(V0=V)	V	
GOT internal data register (GD)*3		GD100~1023	GD100~1023		
Accumulator (A)		A0~A1	–		

*1 Latch relays (L) are treated as internal relays (M) in the GOT-F900.

*2 In computer link connection, index registers cannot be monitored or written.

*3 GB132 to GB255 and GD100 to GD127 can be used in the F920GOT-K.

3) MELSEC-QnA/Q (Q mode) Series

Device name		Setting range		Device number representation	
		GT Designer	DU/WIN		
Bit device	Input (X)	X0~X1FFF	X0~X1FFF	Hexadecimal	
	Output (Y)	Y0~Y1FFF	Y0~Y1FFF		
	Internal relay (M)	M0~M32767	M0~M32767	Decimal	
	Latch relay (L)	L0~L32767	L0~L32767		
	Annunciator (F)	F0~F32767	F0~F32767		
	Link relay (B)	B0~B7FFF	B0~B7FFF	Hexadecimal	
	Special link relay (SB)	SB0~SB7FF	SB0~SB7FF		
	Timer (T)	Contact	TT0~TT32767	T0~T32767	Decimal
		Coil	TC0~TC32767	–	
	Counter (C)	Contact	CT0~CT32767	C0~C32767	
		Coil	CC0~CC32767	–	
	Special relay (SM)	SM0~SM2047	SM0~SM2047		
	Retentive timer (ST)	Contact	SS0~SS32767	SS0~SS32767	
		Coil	SC0~SC32767	SC0~SC32767	
	Step relay (S)	S0~S32767	S0~S32767		
GOT internal bit register (GB) ^{*2}	GB132~GB1023	GB132~GB1023			
Word device	Data register (D)	D0~D32767	D0~D32767	Hexadecimal	
	Special register (SD)	SD0~SD2047	SD0~SD2047		
	Link register (W)	W0~W7FFF	W0~W7FFF		
	Special link register (SW)	SW0~SW7FF	SW0~SW7FF		
	Timer (T)	Present value	TN0~TN32767	T0~T32767	Decimal
		Set value	–	–	
	Counter (C)	Present value	CN0~CN32367	C0~C32367	
		Set value	–	–	
	Retentive timer (present value) (SN)	SN0~SN32767	SN0~SN32767		
	File register (R)	R0~R32767 ^{*1}	R0~R32767 ^{*1}		
Index register (Z)	Z0~Z15	Z			
GOT internal data register (GD) ^{*2}	GD100~GD1023	GD100~GD1023			

*1 File registers in a block changed over by the RSET instruction are regarded as targets.

*2 GB132 to GB255 and GD100 to GD127 can be used in the F920GOT-K.

Restriction in set monitor in computer link for A Series

When a computer link unit for the A Series is attached to the QnA CPU and the GOT-F900 is connected to the unit, the set monitor range is equivalent to that in the AnA CPU, and the restriction shown in the table below is applied (by the restriction in computer link).

Device name		Setting range		Device number representation
		GT Designer	DU/WIN	
Word device	Timer (Present value)	–	0 to 255	Decimal
	Timer (Set value)	–	–	
	Counter (Present value)	–	0 to 255	
	Counter (Set value)	–	–	
	File register	–	–	

–: Monitor and write disabled

Station number specification when configuring a Q multi-CPU system

The CPU station number is specified when setting devices.

0 : a connected CPU (a control CPU in a link connection)

1 to 4 : CPUs with individually specified station numbers

1) FX Series GM positioning unit (GM direct connection)

Device name		Setting range		Device number representation
		GT Designer	DU/WIN	
Bit device	Input (X)	X0~X377	X0~X377	Octal
	Output (Y)	Y0~Y67	Y0~Y67	
	Internal relay (M)	M0~M511	M0~M511	Decimal
	Special auxiliary relay (SM)	M9000~M9175	M9000~M9175	
	GOT internal bit register (GB)	GB132~1023	GB132~1023	
Word device	Data register (D)	D0~D8191	D0~D8191	Decimal
	Special data register (SD)	D9000~D3999	D9000~D3999	
	File register (R)	D4000~D6999	D4000~D6999	
	Index register (Z, V)	Z0~Z6 (32 bits)	Z (32 bits)	
		V0~V6 (16 bits)	V (16 bits)	
GOT internal data register (GD)	GD100~1023	GD100~1023		

*1 Devices cannot be written.

2) FREQROL Series inverter (INV direct connection)

Device name		Setting range		Device number representation
		GT Designer	DU/WIN	
Bit device	Control status (S)	S0:□~S7:□		Decimal
	GOT internal bit register (GB)	GB132~1023		
Word device	Alarm code (A)	A0:□~A7:□		
	Parameter (Pr)	Pr0:□~Pr993:□		
	Program operation (PG)	PG0:□~PG89:□		
	Special parameter (SP)	SP108:□~SP127:□		
GOT internal data register (GD)		GD100~1023		

"□" indicates the station number of the monitored inverter.

Two ways to specify a station number are shown below.

Station No. specification (direct) : Specify the station number of the inverter.
 [Available setting range: 0 to 31]

Station No. specification (indirect): Specify the station number of the inverter indirectly using hexadecimal GOT internal registers (GD100 to GD115).
 [Available setting range: 100 to 115]
 * The station No. corresponds to each device of GD100 to GD115.

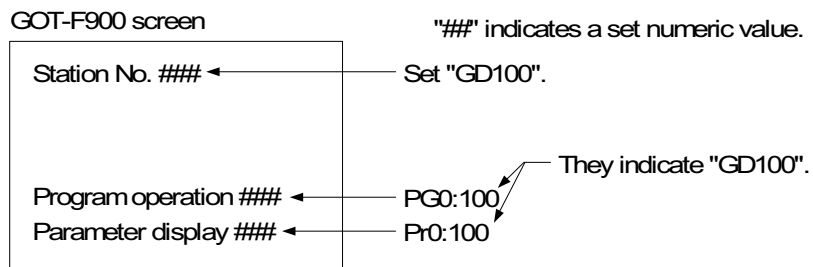

22.7.3 PLC Units Manufactured by Other Companies

1) Microcomputer board (general-purpose communication)

Device name		Setting range		Device number representation
		GT Designer	DU/WIN	
Bit device	Bit data (M)	M0~M2047 *1	M0~M2047	Decimal
	Special memory (M) *2	M8000~M8063	M8000~M8063	
	GOT internal bit register (GB)	GB132~GB1023	GB132~GB1023	
Word device	Word data (D)	D0~D4095	D0~D4095	
	Special memory (M) *2	D8000~D8015	D8000~D8015	
	GOT internal data register (GD)	GD100~GD1023	GD100~GD1023	

*1 The bit data (M) is available in the GT Designer version SW1-E and later.

*2 The special memory is offered for special application (such as interrupt output and communication error information) in the GOT.

2) SYSMAC C Series manufactured by OMRON Corporation

Device name		Setting range		Device number representation
		GT Designer	DU/WIN	
Bit device	I/O relay	..000000~..614315	00000~51115	Decimal
	Internal auxiliary relay	WR00000~WR51115	–	
	Data link relay (LR)	LR00000~LR19915	L0000~L6315	
	Auxiliary memory relay (AR)	AR00000~AR95915 *1	A0000~A2715	
	Holding relay (HR)	HR00000~HR51115	H0000~H9915	
	Timer contact (TIM)	TIM0~TIM2047	T000~T511	
	Counter contact (CNT)	CNT0~CNT2047	C000~C511	
	GOT internal bit register (GB)	GB132~GB1023	GB132~GB1023	
Word device	Data memory (DM)	DM0~DM9999	D0000~D9999	Hexadecimal
	Timer (Present value) (TIM)	TIM0~TIM2047	T000~T511	
	Counter (Present value) (CNT)	CNT0~CNT2047	C000~C511	
	Extension data memory (EM) (current bank)	EM0000~EM9999	–	
	Extension data memory (E*) (bank specification) (*: 0 to C)	E*0000~E*9999 (*:0~C)	–	
	GOT internal data register (GD)	GD100~GD1023	GD100~GD1023	Decimal

*1 When the CS1 Series is connected, auxiliary memory relays (AR) cannot be set to ON or OFF. Do not use them in the key operation setting (bit).

3) FLEX-PC N Series manufactured by FUJI ELECTRIC CO., LTD.

Device name		Setting range		Device number representation
		GT Designer	DU/WIN	
Bit device	Input (X)	–	X0~X7FF	Hexadecimal
	Output (Y)	–	Y0~Y7FF	
	Internal relay (M)	–	M0~M1FFF	
	Latch relay (L)	–	L0~L1FFF	
	State (S)	–	S0~S7FF	
	Special internal relay (M)	–	M800~M81FF	
	GOT internal bit register (GB)	–	GB132~GB1023	
Word device	Timer (T)	–	T0~T3FF	
	Counter (C)	–	C0~C1FF	
	Data register (D)	–	D0~D2FFF	
	Special data register (D)	–	D8000~D81FF	
	Link register (W)	–	W0~W3FFF	
	File register (R)	–	R0~R7FFF	
	GOT internal data register (GD)	–	GD100~GD1023	

4) Machine controller CP9200SH Series manufactured by YASKAWA Electric Corporation

Device name		Setting range		Device number representation
		GT Designer	DU/WIN	
Bit device	Input relay (IB)	IB0~IBFFFF	–	Hexadecimal
	Coil (MB)	MB0~MB4095F	–	*1
	GOT internal bit register (GB)	GB132~GB1023	–	Decimal
Word device	Input register (IW)	IW0~IW7FFF	–	Hexadecimal
	Holding register (MW)	MW0~MW32767	–	Hexadecimal
	GOT internal data register (GD)	GD100~GD1023	–	Decimal

*1 Word address (decimal) + Bit position (hexadecimal)

5) FP Series manufactured by Matsushita Electric Works, LTD.

Device name		Setting range		Device number representation
		GT Designer	DU/WIN	
Bit device	Input relay (X) *3	X0000~X511F	X0000~X511F	Decimal *6
	Output relay (Y)	Y0000~Y511F	Y0000~Y511F	
	Internal relay (R) *4	R0000~R910F	R0000~R910F	
	Link relay (L) *1	L0000~L639F	L0000~L639F	
	Error alarm relay (E) *2*3	E0~E2047	E0~E2047	Decimal
	Timer contact (T) *3	T0~T3071	T0~T3071	
	Counter contact (C) *3	C0~C3071	C0~C3071	
	GOT internal bit register (GB)	GB132~GB1023	GB132~GB1023	
Word device	Elapsed value of timer/counter (EV)	EV0~EV3071	EV0~EV3071	Decimal
	Set value of timer/counter (SV)	SV0~SV3071	SV0~SV3071	
	Data register (DT) *4	DT0~DT16383	DT0~DT16383	
	Link register (LD) *1	LD0~LD8447	LD0~LD8447	
	File register (FL) *1*5	FL0~FL32764	FL0~FL32764	
	GOT internal data register (GD)	GD100~GD1023	GD100~GD1023	

Pulse relays (P) and index registers (IX, IY and I) are not available.

*1 FP0 is excluded.

*2 Only FP2SH is available.

*3 Write is disabled.

*4 Special relays (R9000 to R910F) and special data registers (DT9000 to DT9255) are included also. However, access is disabled in special data registers from D90000 in the FP Series.

*5 Access is enabled only in the bank 0.

*6 Bit device number (3-digit decimal number) + Bit position (1-digit hexadecimal number)

6) SLC500/MicroLogix Series manufactured by Allen-Bradley Co., Inc.

a) SLC500 Series

i) GT Designer (earlier than Version 5.05F) and DU/WIN (earlier than Version 2.50)

Device name		Setting range		Device number representation
		GT Designer	DU/WIN	
Bit device	Bit (B)	B0030000~B003255F B0100000~B255255F	B0030000~B003255F B0100000~B255255F	Hexadecimal
	Timer (T) (timing bit)	TT0040000~TT0042550 TT0100000~TT2552550	—	Decimal
	Timer (T) (completion bit)	TN0040000~TN0042550 TN0100000~TN2552550	T0040000~T0042550 T0100000~T2552550	
	Counter (C) (up counter)	CU0050000~CU0052550 CU0100000~CU2552550	—	
	Counter (C) (down counter)	CD0050000~CD0052550 CD0100000~CD2552550	—	
	Counter (C) (completion bit)	CN0050000~CN0052550 CN0100000~CN2552550	C0050000~C0052550 C0100000~C2552550	
	GOT internal bit register (GB)	GB132~GB1023	—	
Word device	Timer (T) *1 (set value)	TP004000~TP004255 TP010000~TP255255	T004000~T004255 T010000~T255255	Decimal
	Timer (T) *1 (current value)	TA004000~TA004255 TA010000~TA255255		
	Counter (T) *1 (set value)	CP005000~CP005255 CP010000~CP255255	C004000~C005255 C010000~C255255	
	Counter (T) *1 (current value)	CA005000~CA005255 CA010000~CA255255		
	Integer (N)	NO07000~N007255 NO10000~N255255	NO07000~N007255 NO10000~N255255	
	GOT internal data register (GD)	GD100~GD1023	—	

*1 32-bit cannot be chosen.

ii) GT Designer (Version 5.05F or later) and DU/WIN (Version 2.50 or later)

Device name		Setting range		Device number representation
		GT Designer	DU/WIN	
Bit device	Bit (B)	B3:0/0~B3:255/15 B10:0/0~B255:255/15	B3:0/0~B3:255/15 B10:0/0~B255:255/15	Hexadecimal
	Timer (T) (timing bit)	T4:0/TT~T4:255/TT T10:0/TT~T255:255/TT	T4:0/TT~T4:255/TT T10:0/TT~T255:255/TT	Decimal
	Timer (T) (completion bit)	T4:0/DN~T4:255/DN T10:0/DN~T255:255/DN	T4:0/DN~T4:255/DN T10:0/DN~T255:255/DN	
	Counter (C) (up counter)	C5:0/CU~C5:255/CU C10:0/CU~C255:255/CU	C5:0/CU~C5:255/CU C10:0/CU~C255:255/CU	
	Counter (C) (down counter)	C5:0/CD~C5:255/CD C10:0/CD~C255:255/CD	C5:0/CD~C5:255/CD C10:0/CD~C255:255/CD	
	Counter (C) (completion bit)	C5:0/DN~C5:255/DN C10:0/DN~C255:255/DN	C5:0/DN~C5:255/DN C10:0/DN~C255:255/DN	
	GOT internal bit register (GB)	GB132~GB1023	GB132~GB1023	
Word device	Timer (T) *1 (set value)	T4:0.PRE~T4:255.PRE T10:0.PRE~T255:255.PRE	T4:0.PRE~T4:255.PRE T10:0.PRE~T255:255.PRE	Decimal
	Timer (T) *1 (current value)	T4:0.ACC~T4:255.ACC T10:0.ACC~T255:255.ACC	T4:0.ACC~T4:255.ACC T10:0.ACC~T255:255.ACC	
	Counter (T) *1 (set value)	C5:0.PRE~C5:255.PRE C10:0.PRE~C255:255.PRE	C5:0.PRE~C5:255.PRE C10:0.PRE~C255:255.PRE	
	Counter (T) *1 (current value)	C5:0.ACC~C5:255.ACC C10:0.ACC~C255:255.ACC	C5:0.ACC~C5:255.ACC C10:0.ACC~C255:255.ACC	
	Integer (N)	N7:0~N7:255 N10:0~N255:255	N7:0~N7:255 N10:0~N255:255	
	GOT internal data register (GD)	GD100~GD1023	GD100~GD1023	

*1 32-bit cannot be chosen.

File number and element specification range

Specify the file number and an element in decimal numbers. However, specify the bit position of a bit (B) in a hexadecimal number.

Device name (symbol)		File number *1	Available element specification range	
Bit device	Bit (B)	3	10~255	0~255 *2
	Timer (time counting bit) (TT)	4	10~255	0~255
	Timer (completion bit) (TN)	4	10~255	0~255
	Counter (effective up-count bit) (CU)	5	10~255	0~255
	Counter (effective down-count bit) (CD)	5	10~255	0~255
	Counter (completion bit) (CN)	5	10~255	0~255
Word device	Timer (set value) (TP)	4	10~255	0~255
	Timer (present value) (TA)	4	10~255	0~255
	Counter (set value) (CP)	5	10~255	0~255
	Counter (present value) (CA)	5	10~255	0~255
	Integer (N) (N)	7	10~255	0~255

*1 File numbers 10 to 255 are available in the user setting.

*2 For each element, the bit position can be specified in the range from 0 to F (15).

b) MicroLogix 1000/1200/1500 Series

i) GT Designer (Version 5.05F or later) and DU/WIN (Version 2.50 or later)

Device name		Setting range		Device number representation
		GT Designer	DU/WIN	
Bit device	Bit (B)	B3:0/0~B255:255/15	B3:0/0~B255:255/15	Hexadecimal
	Timer (T) (timing bit)	T3:0/TT~T255:255/TT	T3:0/TT~T255:255/TT	Decimal
	Timer (T) (completion bit)	T3:0/DN~T255:255/DN	T3:0/DN~T255:255/DN	
	Counter (C) (up counter)	C3:0/CU~C255:255/CU	C3:0/CU~C255:255/CU	
	Counter (C) (down counter)	C3:0/CD~C255:255/CD	C3:0/CD~C255:255/CD	
	Counter (C) (completion bit)	C3:0/DN~C255:255/DN	C3:0/DN~C255:255/DN	
	GOT internal bit register (GB)	GB132~GB1023	GB132~GB1023	
Word device	Timer (T) *1 (set value)	T3:0.PRE~T255:255.PRE	T3:0.PRE~T255:255.PRE	Decimal
	Timer (T) *1 (current value)	T3:0.ACC~T255:255.ACC	T3:0.ACC~T255:255.ACC	
	Counter (T) *1 (set value)	C3:0.PRE~C255:255.PRE	C3:0.PRE~C255:255.PRE	
	Counter (T) *1 (current value)	C3:0.ACC~C255:255.AC C	C3:0.ACC~C255:255.AC C	
	Integer (N)	N3:0~N255:255	N3:0~N255:255	
	GOT internal data register (GD)	GD100~GD1023	GD100~GD1023	

*1 32-bit cannot be chosen.

File number and element specification range

Specify the file number and an element in decimal numbers. However, specify the bit position of a bit (B) in a hexadecimal number.

Device name (symbol)		File number*1	Available element specification range
Bit device	Bit (B)	3~255	0~255 *2
	Timer (timing bit) (T)	3~255	0~255
	Timer (completion bit) (T)	3~255	0~255
	Counter (up counter) (C)	3~255	0~255
	Counter (down counter) (C)	3~255	0~255
	Counter (completion bit) (C)	3~255	0~255
Word device	Timer (set value) (T)	3~255	0~255
	Timer (current value) (T)	3~255	0~255
	Counter (set value) (C)	3~255	0~255
	Counter (current value) (C)	3~255	0~255
	Integer (N) (N)	3~255	0~255

*1 File numbers 3 to 255 are available in the user setting.

*2 For each element, the bit position can be specified in the range from 0 to 15.

7) S7-200/300 Series manufactured by Siemens AG

a) S7-200 Series

Device name		Setting range		Device number representation
		GT Designer	DU/WIN	
Bit device	Variable Memory (V)	V00~V51197	V0.0~V5119.7	Decimal
	Input (I)	I00~I77	I0.0~I7.7	
	Output (Q)	Q00~Q77	Q0.0~Q7.7	
	Bit memory (M)	M00~M317	M0.0~M31.7	
	Special Memory (SM)	SM00~SM1947	SM0.0~SM194.7	
	Timer (T) *1	T0~T255	T0~T255	
	Counter (C) *1	C0~C255	C0~C255	
	Sequence Control Relay (S)	S00~S317	S0.0~S31.7	
Word device	Variable Memory (V) *6	VW0~VW5118	VW0~VW5118	
	Input (I) *6	IW0~IW6	IW0~IW6	
	Output (Q) *6	QW0~QW6	QW0~QW6	
	Analog Input (AI) *2*6	AIW0~AIW30	AIW0~AIW30	
	Analog Output (AQ) *6	AQW0~AQW30	AQW0~AQW30	
	Bit memory (M) *6	MW0~MW30	MW0~MW30	
	Special Memory (SM) *3*6	SMW0~SMW192	SMW0~SMW192	
	Timer (T) (16bit) *4	T0~T255	T0~T255	
	Counter (C) (16bit) *4	C0~C255	C0~C255	
	High Speed Counter (HC) (32bit) *5	HC0~HC2	HC0~HC2	
	Sequence Control Relay (S) *6	SW0~SW30	SW0~SW30	

*1 Bit devices T and C cannot be written.

*2 Word devices HC and AI cannot be written.

*3 Word device SM cannot be monitored.

*4 Word devices T and C are the 16-bit type.

*5 Word device HC is the 32-bit type.

*6 Only even byte addresses are available.

Note on number representation

A decimal point exists when using the GT Designer but not when using the DU/WIN.

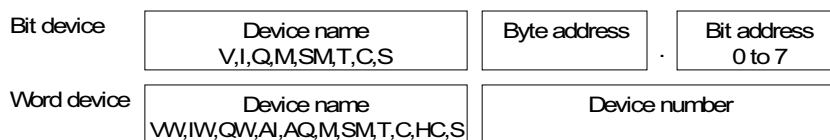

b) S7-300 Series

Device name		Setting range		Device number representation
		GT Designer	DU/WIN	
Bit device	Input relay (I)	I0~I5117	I0.0~I511.7	Decimal
	Output relay (Q)	Q0~Q5117	Q0.0~Q511.7	
	Bit memory (M)	M0~M20477	M0.0~M2047.7	
	GOT internal bit register (GB)	GB132~GB1023	GB132~GB1023	
Word device	Present value of timer (T)	T0~T511	T0~T511	
	Present value of counter (C)	C0~C511	C0~C511	
	Data register (D)	D000100000~D102365534	DB□.DBW0~DB□.DBW65534	
	GOT internal data register (GD)	GD100~GD1023	GD100~GD1023	

"□" indicates a number in the range from 1 to 1023.

Only even values are available as device numbers (DBW values).

Note on number representation

A decimal point exists when using the GT Designer but not when using the DU/WIN.

Bit device	Device name I,Q,M	Byte address 0 to 511,2047	·	Bit address 0 to 7
Word device	Device name T,C	Device number 000 to 511		
	Device name DB	Block number 1 to 1023	·	Byte address DBW0 to DBW65534

22.8 Key Code List

Key code list used in each object (Unavailable in the F920GOT-K.)

a) Key codes used in the numeric input function

Key code (H)	Application
0008	Deletes the numeric value entered by one digit from the bottom (BS).
000D	Writes a numeric value to the write destination device or moves the cursor.
002D	"_"
002E	"•"
0030 to 0046	Enters a numeric value.
0082	Moves the cursor upward.
0083	Moves the cursor downward.
0088	Deletes a numeric value being input.

*1 Applicable to F930GOT or F933GOT: Ver. 4.00 or later; F930GOT-K-E: from the first product; F940GOT: Ver. 6.00 or later; F940WGOT: Ver. 1.00 or later

b) Key codes used in the ASCII code input function

Key code (H)	Application
0008	Deletes the numeric value entered by one digit from the bottom (BS).
000D	Writes a numeric value to the write destination device or moves the cursor.
ASCII code, shift JIS Chinese character code	Inputs a character.
0082	Moves the cursor upward.
0083	Moves the cursor downward.
0088	Deletes a character being input.

*1 Applicable to F930GOT or F933GOT: Ver. 4.00 or later; F930GOT-K: from the first product; F940GOT: Ver. 6.00 or later; F940WGOT: Ver. 1.00 or later

c) Key codes used in the alarm list display function

Key code (H)	Application
FFB0	Displays the cursor.
FFB1	Hides the cursor.
FFB2	Moves the cursor upward.
FFB3	Moves the cursor downward.
FFB8	Displays the detailed information.

d) Key codes used in the alarm history display function

Key code (H)	Application
FFB0	Displays the cursor.
FFB1	Hides the cursor.
FFB2	Moves the cursor upward.
FFB3	Moves the cursor downward.
FFB6	Deletes the displayed contents of selected alarms.
FFB7	Deletes the displayed contents of all alarms.
FFB8	Displays the detailed information.
FFBB	Resets a specified device.

e) Key codes used in the entry code input function

Key code (H)	Application
FF68	Displays the entry code input screen.
FF69	Resets the entry code.

f) Key code used in the buzzer sound setting function

Key code (H)	Application
FFFE	Does not issue the buzzer sound of touch keys.

g) Key codes used in the hard copy function

Key code (H)	Application
FF17	Starts hard copy.
FF18	Finishes hard copy.

22.9 Label pattern (F930GOT-K)

Copy this pattern to the OHP sheet offered as an accessory.

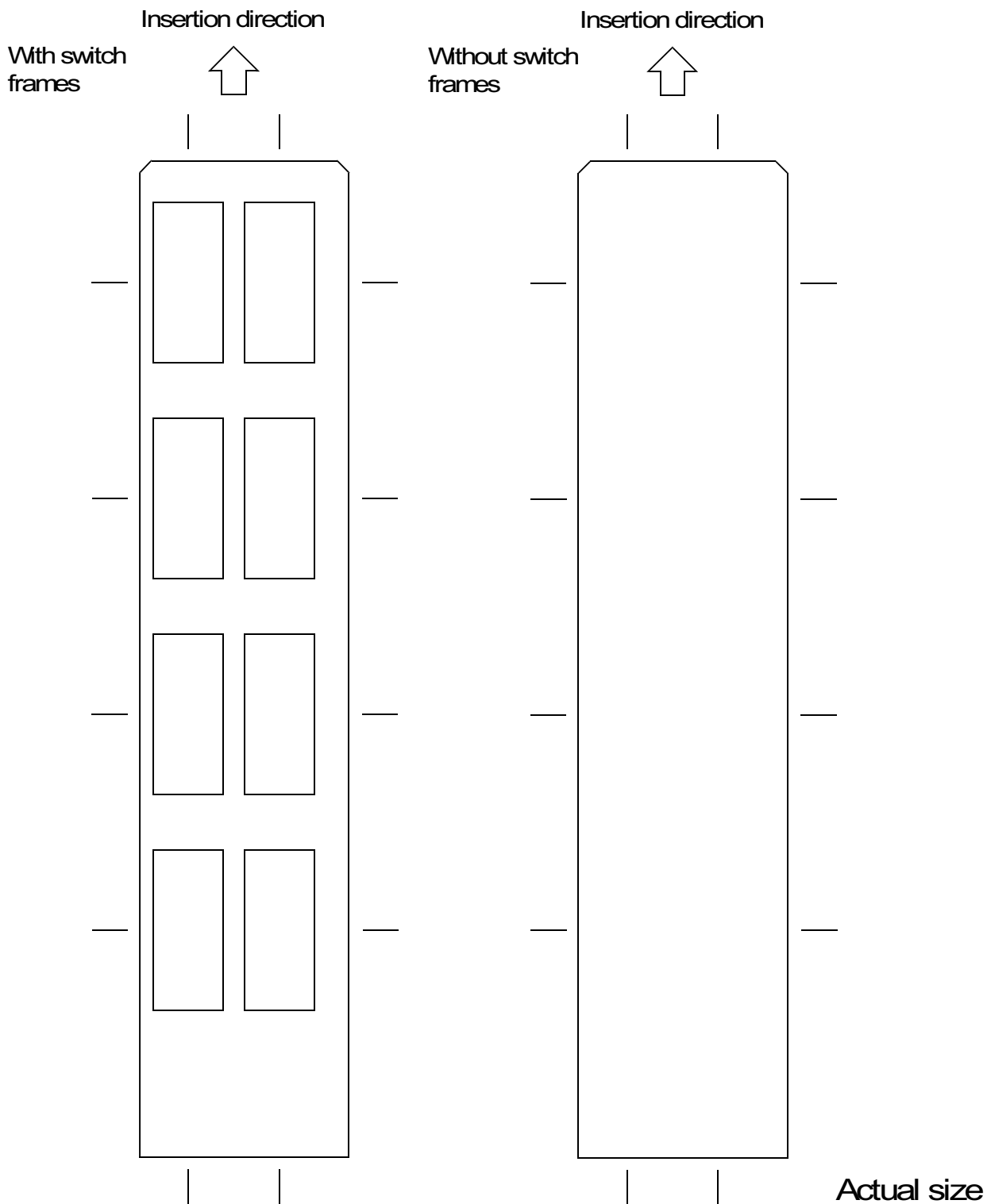

MEMO

HEADQUARTERS

MITSUBISHI ELECTRIC EUROPE B.V.
 German Branch
 Gothaer Straße 8
D-40880 Ratingen
 Phone: +49 (0) 21 02 / 486-0
 Fax: +49 (0) 21 02 / 4 86-11 20
 e mail: megfamail@meg.mee.com

MITSUBISHI ELECTRIC EUROPE B.V.
 French Branch
 25, Boulevard des Bouvets
F-92741 Nanterre Cedex
 Phone: +33 1 55 68 55 68
 Fax: +33 1 55 68 56 85
 e mail: factory.automation@fra.mee.com

MITSUBISHI ELECTRIC EUROPE B.V.
 UK Branch
 Travellers Lane
GB-Hatfield Herts. AL10 8 XB
 Phone: +44 (0) 1707 / 27 61 00
 Fax: +44 (0) 1707 / 27 86 95

MITSUBISHI ELECTRIC EUROPE B.V.
 Italian Branch
 Via Paracelso 12
I-20041 Agrate Brianza (MI)
 Phone: +39 (0) 39 6053 1
 Fax: +39 (0) 39 6053 312
 e mail: factory.automation@it.mee.com

MITSUBISHI ELECTRIC EUROPE B.V.
 Spanish Branch
 Carretera de Rubí 76-80
E-08190 Sant Cugat del Vallés
 Phone: +34 9 3 / 565 3131
 Fax: +34 9 3 / 589 2948
 e mail: industrial@sp.mee.com

MITSUBISHI ELECTRIC CORPORATION
 Office Tower "Z" 14 F
 8-12,1 chome, Harumi Chuo-Ku
Tokyo 104-6212
 Phone: +81 3 / 622 160 60
 Fax: +81 3 / 622 160 75

MITSUBISHI ELECTRIC AUTOMATION
 500 Corporate Woods Parkway
Vernon Hills, IL 60061
 Phone: +1 847 / 478 21 00
 Fax: +1 847 / 478 22 83

EUROPEAN REPRESENTATIVES

GEVA AUSTRIA
 Wiener Straße 89
A-2500 Baden
 Phone: +43 (0) 2252 / 85 55 20
 Fax: +43 (0) 2252 / 488 60
 e mail: office@geva.at

Getronics b.v. BELGIUM
 Control Systems
 Pontbeeklaan 43
B-1731 Asse-Zellik
 Phone: +32 (0) 2 / 467 17 51
 Fax: +32 (0) 2 / 467 17 45
 e mail: infoautomation@getronics.com

TELECON CO. BULGARIA
 4, A. Ljapchev Blvd.
BG-1756 Sofia
 Phone: +359 (0) 2 / 97 44 05 8
 Fax: +359 (0) 2 / 97 44 06 1

INEA CR d.o.o. CROATIA
 Drvinje 63
HR-10000 Zagreb
 Phone: +385 (0)1/ 36 67 140
 Fax: +385 (0)1/ 36 67 140

AutoCont Control Systems s.r.o. CZECHIA
 Nemocnicni 12
CZ-702 00 Ostrava 2
 Phone: +420 59 / 6152 111
 Fax: +420 59 / 6152 562
 e mail: consys@autocont.cz

louis poulsen industri & automation DENMARK
 Geminivej 32
DK-2670 Greve
 Phone: +45 (0) 43 / 95 95 95
 Fax: +45 (0) 43 / 95 95 91
 e mail: lpia@lpmail.com

UTU Elektrotehnika AS ESTONIA
 Pärnu mnt.160i
EE-11317 Tallinn
 Phone: +372 (0) 6 / 51 72 80
 Fax: +372 (0) 6 / 51 72 88
 e mail: utu@utu.ee

Beijer Electronics OY FINLAND
 Ansatie 6a
FIN-01740 Vantaa
 Phone: +358 (0) 9 / 886 77 500
 Fax: +358 (0) 9 / 886 77 555
 e mail: info@beijer.fi

UTECO A.B.E.E. GREECE
 5, Mavrogenous Str.
GR-18542 Piraeus
 Phone: +30 10 / 42 10 050
 Fax: +30 10 / 42 12 033
 e mail: uteco@uteco.gr

Meltrade Automatika Kft. HUNGARY
 55, Harmat St.
HU-1105 Budapest
 Phone: +36 (0)1 / 2605 602
 Fax: +36 (0)1 / 2605 602
 e mail: office@meltrade.hu

MITSUBISHI ELECTRIC EUROPE B.V. - Irish Branch IRELAND
 Westgate Business Park
IRL-Dublin 24
 Phone: +353 (0) 1 / 419 88 00
 Fax: +353 (0) 1 / 419 88 90
 e mail: sales.info@meir.mee.com

EUROPEAN REPRESENTATIVES

POWEL SIA LATVIA
 Lienes iela 28
LV-1009 Riga
 Phone: +371 784 / 22 80
 Fax: +371 784 / 22 81
 e mail: utu@utu.lv

UTU POWEL UAB LITHUANIA
 Savanoriu pr. 187
LT-2053 Vilnius
 Phone: +370 (0) 232-2980
 Fax: +370 (0) 232-2980
 e mail: powel@utu.lt

Getronics b.v. NETHERLANDS
 Control Systems
 Donauweg 2 B
NL-1043 AJ Amsterdam
 Phone: +31 (0) 20 / 587 67 00
 Fax: +31 (0) 20 / 587 68 39
 e mail: info.gia@getronics.com

Beijer Electronics AS NORWAY
 Teglverksveien 1
N-3002 Drammen
 Phone: +47 (0) 32 / 24 30 00
 Fax: +47 (0) 32 / 84 85 77
 e mail: info@elc.beijer.no

MPL Technology Sp. z o.o. POLAND
 ul. Sliczna 36
PL-31-444 Kraków
 Phone: +48 (0) 12 / 632 28 85
 Fax: +48 (0) 12 / 632 47 82
 e mail: krakow@mpl.pl

Sirius Trading & Services srl ROMANIA
 Bd. Lacul Tei nr. 1 B
RO-72301 Bucuresti 2
 Phone: +40 (0) 21 / 201 7147
 Fax: +40 (0) 21 / 201 7148
 e mail: sirius_t_s@fx.ro

ACP Autocomp a.s. SLOVAKIA
 Chalupkova 7
SK-81109 Bratislava
 Phone: +421 (02) / 5292-22 54, 55
 Fax: +421 (02) / 5292-22 48
 e mail: info@acp-autocomp.sk

INEA d.o.o. SLOVENIA
 Stegne 11
SI-1000 Ljubljana
 Phone: +386 (0) 1-513 8100
 Fax: +386 (0) 1-513 8170
 e mail: inea@inea.si

Beijer Electronics AB SWEDEN
 Box 426
S-20124 Malmö
 Phone: +46 (0) 40 / 35 86 00
 Fax: +46 (0) 40 / 35 86 02
 e mail: info@beijer.se

ECONOTEC AG SWITZERLAND
 Postfach 282
CH-8309 Nürensdorf
 Phone: +41 (0) 1 / 838 48 11
 Fax: +41 (0) 1 / 838 48 12
 e mail: info@econotec.ch

GTS TURKEY
 Darülaceze Cad. No. 43 KAT: 2
TR-80270 Okmeydani-Istanbul
 Phone: +90 (0) 212 / 320 1640
 Fax: +90 (0) 212 / 320 1649
 e mail: gts@turk.net

MIDDLE EAST REPRESENTATIVE

TEXEL Electronics LTD. ISRAEL
 Box 6272
IL-42160 Netanya
 Phone: +972 (0) 9 / 863 08 91
 Fax: +972 (0) 9 / 885 24 30
 e mail: texel_me@netvision.net.il

EURASIAN REPRESENTATIVES

TEHNIKON BELARUS
 Oktjabrskaya 16/5, Ap 704
BY-220030 Minsk
 Phone: +375 (0) 17 / 22 75 704
 Fax: +375 (0) 17 / 22 76 669
 e mail: tehnikon@belsonet.net

AVTOMATIKA SEVER RUSSIA
 Krapivnij Per. 5, Of. 402
RUS-194044 St Petersburg
 Phone: +7 812 / 1183 238
 Fax: +7 812 / 3039 648
 e mail: pav@avtsev.spb.ru

CONSYS RUSSIA
 Promyshlennaya St. 42
RUS-198099 St Petersburg
 Phone: +7 812 / 325 36 53
 Fax: +7 812 / 325 36 53
 e mail: consys@consys.spb.ru

ICOS RUSSIA
 Industrial Computer Systems Zao
 Ryazanskij Prospekt 8a, Office 100
RUS-109428 Moscow
 Phone: +7 095 / 232 - 0207
 Fax: +7 095 / 232 - 0327
 e mail: mail@icos.ru

NPP Uralelektra RUSSIA
 Sverdlova 11a
RUS-620027 Ekaterinburg
 Phone: +7 34 32 / 53 27 45
 Fax: +7 34 32 / 53 24 61
 e mail: elektra@etel.ru

STC Drive Technique RUSSIA
 Poslannikov Per. 9, str.1
RUS-107005 Moscow
 Phone: +7 095 / 786 21 00
 Fax: +7 095 / 786 21 01
 e mail: info@privod.ru

JV-CSC Automation UKRAINE
 15, Marina Raskovoyi St.
U-02002 Kiev
 Phone: +380 (0)44 / 568 5316
 Fax: +380 (0)44 / 568 5317
 e mail: csc-a@csc-a.kiev.ua

AFRICAN REPRESENTATIVE

CBI Ltd SOUTH AFRICA
 Private Bag 2016
ZA-1600 Isando
 Phone: +27 (0) 11/ 928 2000
 Fax: +27 (0) 11/ 392 2354
 e mail: cbi@cbi.co.za